

Your Future Starts Here At



80th Anniversary

Los Angeles City College 2009-2011 Catalog

A message from the President

Welcome to Los Angeles City College

Dear LACC Student, At Los Angeles City College (LACC), faculty and students are striving toward academic excellence. This commitment to excellence has earned our campus honors and awards. LACC has a nationally recognized Math Club and Forensics Team. LACC continually offers the highest level of instruction and our student services division is committed to providing access to a comprehensive educational and support system for a diverse student population that empowers them to reach their educational and personal goals. LACC is a comprehensive community college that enrolls over 17,000 students. The college offers a full range of educational programs, including transfer; vocational and career education; general education courses; and basic skills.

LACC is currently undergoing a transformation as its comprehensive facilities master plan is underway. With a \$300 million dollar bond program in the works, LACC will open its new Science and Technology Building this fall. This new building will be the home to Chemistry, Dental Technology, Life Science, and Nursing, providing comprehensive state of that art instruction in building careers for our students.

LACC offers 66 AA/AS degrees, 80 certificate programs and approximately 1,000 different classes each semester. Accredited by the Western Association of Schools and Colleges, your degree or certificate from LACC certifies that you have met the highest national standards. LACC has developed multiple programs to ensure our students succeed in college, including an emphasis on learning communities.

With nearly 200 dedicated full-time faculty and administrators and over 100 caring and supportive staff members, LACC prides itself on a student-centered philosophy and approach. Encompassing an area of 49-acres and coined the "Hollywood campus," since 1929, LACC has played a vital role in the social and economic development of East Hollywood and enhanced quality of life by providing a world-class, affordable education. We embody and implement the college vision as an urban oasis of learning that educates minds, open hearts, and celebrates community.

Los Angeles City College is what you, the students make it. We wish you every success in the pursuit of your academic aspirations.

Dr. Jamillah Moore,
President, Los Angeles City College



LOS ANGELES CITY COLLEGE ADMINISTRATION

Dr. Jamillah Moore	President
Dr. Kimberly Perry	Vice President, Academic Affairs
Dr. Lawrence Bradford	Vice President, Services Services
Paul Carlson	Vice President, Administrative Services
Belinda Acuna	Dean, Student Services
Randy Anderson	Dean, Student Services
Dr. Merrill Eastcott	Dean, Academic Affairs
Allison Jones	Dean, Academic Affairs
William Marmolejo	Dean, Enrollment
Dr. Joyce Moore	Dean, Academic Affairs
Dr. Edward Pai	Dean, Institutional Effectiveness
Alex Davis	Dean, Economic Dev. and Workforce Education
Eric Peters	Associate Dean, Student Services
Corey Rodgers	Associate Dean, EOP&S
Jeremy Villar	Associate Dean, Student Services
Christi O'Connor	Bookstore Manager
Cristy Passman	Compliance Officer
Lenore Saunders	Administrative Analyst

Los Angeles City College
855 North Vermont Avenue • Los Angeles, CA 90029
www.lacitycollege.edu • 323.953.4000



LOS ANGELES COMMUNITY COLLEGE BOARD OF TRUSTEES

Georgia L. Mercer	President
Miguel Santiago	Vice President
Nancy Pearlman	Second Vice President
Kelly G. Candaele	
Mona Field	
Tina Park	
Sylvia Scott-Hayes	
Rodney D. Robinson	Interim Student Trustee

LOS ANGELES COMMUNITY COLLEGE DISTRICT ADMINISTRATION

Dr. Daniel J. LaVista	Chancellor
Dr. Adriana D. Barrera	Deputy Chancellor
Dr. Yasmin Delahoussaye	Interim Vice Chancellor for Educational Programs and Institutional Effectiveness
Vacant	Vice Chancellor Economic & Workforce Development
Larry H. Eisenberg	Executive Director Facilities Planning & Development
Camille A. Goulet	General Counsel
Jeanette Gordon	Chief Financial Officer/Treasurer

Los Angeles Community College District
770 Wilshire Boulevard • Los Angeles, CA 90017
www.laccd.edu • 213.891.2000



Note to Students:

Enrollment Fees

Governor Schwarzenegger signed a bill raising the enrollment fee from \$20 to \$26 per unit. Since this fee increase applies to students who have already registered, as well as new registrants, all Los Angeles City College students are affected by this increase.

For students who have already qualified for the Board of Governors fee waiver, the fee increase is fully covered and no further action needs to be taken. Students who would like to apply or get more information on financial aid, please visit the financial aid section of the college website at lacitycollege.edu.

Students are encouraged to pay all outstanding fees now and avoid the long lines at the beginning of the semester. The fall semester begins Monday, August 31. Fees can be paid in person at the Business Office in AD 111 OR paid through the Student Information System available online OR by calling (323) 226-1999.

For updated information on the enrollment fees currently owed, log on to http://www.laccd.edu/student_information/current_students.htm, and then click on "view and pay fees." For students who have not registered yet, the \$26.00 per unit enrollment fee will be assessed during registration.





TABLE OF CONTENTS

GENERAL INFORMATION

- Vision Statement 1
- About LACC 1
- History 1
- District Philosophy 1
- Functions of the LACCD Colleges 1
- Accuracy Statement 2
- Accreditation & Professional Program Approvals 2
- Student Right-to-Know Disclosure 2
- Equal-Opportunity Policy Compliance Procedure 2
- Prohibited Discrimination & Harassment Policy 2
- Limited English Proficiency Policy 3
- Alternative Publication Formats 3
- Campus Security Reports 3
- Student Responsibility to be Informed 3
- Catalog Rights 3

ADMISSIONS INFORMATION

- Academic Year 4
- Eligibility Requirements 4
- California Residency Requirement, Non-Residents, Residence Appeal, Non-Citizen Student 4
- Application for Admissions to LACC 4
- International Students 4
- Registering for Classes New, Returning 5
 - Continuing Students Class Unit Limit, Cancellation of Classes 5
- Matriculation 5
 - Admissions, Assessment, Orientation, Counseling, Follow-Up and Student Agrees to Exemption, Waiver and Appeal 5

PREREQUISITES/CO-REQUISITES ADVISORIES & CHALLENGES

- Prerequisite, Co-requisite, Advisory and A Satisfactory Grade 6

CHALLENGE POLICY/PROCEDURE 6

TUITION & FEES 6

FINANCIAL AID

- What is Financial Aid? 7
- How to Apply 8
- Priority Dates & Deadlines 8
- Verification 8
- Federal Refund Requirements 8
- Federal & State Financial Aid 8-9
- The Cal Grant Program 9
- Satisfactory Academic Progress Policy 10
- Fraud 11
- Scholarships 11
- Foundation 11

GRADUATION REQUIREMENTS:

- Graduation Requirements 12
- Core Competencies 12
- General Graduation Requirements 12
- Transfer vs. Career Education Programs 12
- “Plan A” (Transfer) Graduation Requirements 12
- “Plan B” (Occupational) Graduation Requirements 13
- Graduation Petitions for Degree 14
- Certificate of Completion 14

GRADUATION WITH HONORS

TRANSFER INFORMATION:

- General Information for Transfer 15
- Transfer of Career Education Classes 15
- Course Credit Value 15

*California Articulation Number (CAN) System	16
The University of California (UC) System	15
The California State University (CSU) System	16
UC & CSU General Education Articulation Agreements	16
Intersegmental General Education Transfer Curriculum (IGETC) Policy	17
California State University Los Angeles (CSULA) Major Department Requirements	
Independent California Colleges & Universities	19
Honors Program	20
University Transfer Center	20
CSU, IGETC Comparison Chart	21
PROGRAMS & COURSES:	
Listing of Degree & Certificate Programs	22
Degree, Certificate & Course Descriptions	
Accounting & Advertising	See "Business"
Anatomy	See "Biology/Anatomy"
Astronomy	See "Physics/Astronomy"
Administration of Justice & Corrections	24
American Cultures	See "Social Science"
African-American Studies, Asian-American Studies, Chicano Studies	
Anthropology	See "Social Science"
Architecture	26
Art	27
Biology/Anatomy	28
Anatomy, Biology, Microbiology, Physiology	
Business Administration	29
Accounting, Advertising, Bookkeeping, Business Administration, Finance & Banking, Management, Marketing, Real Estate	
CAOT - Computer Applications / Office Technology	35
Chemistry	38
Child Development	38
Cinema & Television	43
CSIT- Computer Science / Information Technology	46
Computer Technology	51
Cooperative Education	52
Dental Technology	52
Earth Science	55
Earth Science, Geography, Geology, Meteorology, Oceanography	
Economics	See "Social Science"
Electronics	55
Engineering (Electric & General)	57
English/ESL	57
English Literacy/Citizenship	See "Citizenship"
Family & Consumer Studies (Dietetics/School Food Service)	58
Finance & Banking	See "Business"
Foreign Language	61
Arabic, Armenian, Chinese, French, Filipino, German, Italian, Japanese, Korean, Latin, Portuguese, Russian, Spanish	
Health	62
History	See "Social Science"
Humanities	62
Journalism	63
Law	64
Business Law, Paralegal	
Learning Skills	66
Liberal Arts ("Transfer Major")	66
Library Science	68
Management	See "Business"
Marketing	See "Business"
Mathematics	68
Microbiology	See "Biology/Anatomy"



Music (Vocal & Instrumental)	70
Nursing	76
Paralegal.	See “Law”
Personal Development.....	77
Philosophy	78
Photography.....	78
Physical Education	79
Physical Science.....	79
Physics/Astronomy.....	80
Physiology See	“Biology/Anatomy”
Political ScienceSee	“Social Science”
Psychology (Human Services)	81
Radiologic Technology (X-Ray)	83
Real Estate	See “Business”
Science	85
Social Science	85
Anthropology, American Cultures, Economics, History, Political Science, Sociology	
Sociology	See “Social Science”
Speech	87
Theatre Arts/Theatre Academy.....	88
Workforce Development Readiness Academy.....	92
Course Descriptions.....	95
Workforce	190
Non Credit	195
POLICIES: ACADEMIC	
Student Records & Directory Information	198
Academic Renewal	198
Transcript Verification	198
Conditions of Enrollment.....	198
Concurrent Enrollment	198
Attendance	199
Instructor Notification	199
Attendance Definitions	199
Grades & Grading Policies	199
Deans’ & President’s Honors	200
Grades & Grade Changes	200
Pass/No-Pass Option	200
Directed Study Courses	200
Grade Reports	202
Adding/Dropping Classes & College Withdrawal	202
Probation & Dismissal	202
Course Repetition	203
Credit by Examination	203
Credit for Courses from Non-Accredited Institutions	203
Evaluation of Foreign/International Transcripts	204
Cancellation of Classes	204
Classroom Conduct	204
POLICIES: STUDENT	
Standards of Student Conduct	204
Student Discipline Procedures	206
Student Grievance Procedures	206
POLICIES: GENERAL	
Drug-Free Campus	206
Educational Environment Policy	207
Family Education Rights & Privacy Act	207
Health Fee Waiver	207

Sex Offender Registration	207
Smoking Policy	207
Workforce Diversity	207
SERVICES & PROGRAMS	
Admissions	207
Assessment	207
Associated Student Organization (ASO)	207
Bookstore	208
Business Office	209
CAHSEE Bridge to College	210
CalWORKs	210
Campus Child Development Center	210
Career Center	210
Citizenship/English Literacy	See "English Literacy/Civics"
City College at Wilshire	See "Satellite Locations"
Community Services	210
Compliance Officer	210
Contract Education	210
Counseling, Academic	211
Disabled Student Services see	"Office of Special Services"
English Literacy & Civics	211
Extended Opportunity Programs & Services (EOP&S)	211
Extra- & Co-Curricular Activities	211
Financial Aid	212
First Year Experience	212
Foundation	212
Foster Care	212
Guardian Scholars	212
Health & Wellness Center	213
Healthy Advocacy Response Team (HART)	213
Honors Program	213
Intercollegiate Athletics	213
Instructional Television (ITV)	213
International Students	213
Job Placement	214
Learning Skills Center	214
Library	214
Lost & Found	214
Office of Special Services	214
Satellite Education Centers	215
City College at Wilshire; (Atwater Village) Northeast Campus	
Student Activities	215
Student Assistant Center	215
TRIO - Student Support Services	215
University Transfer Center	215
Upward Bound	215
Vehicles on Campus	215
Veteran's Affairs	216
FACULTY LISTING	
Department Chairs	217
Current & Retired Faculty	218
GLOSSARY	228

GENERAL INFORMATION

Set on an attractive 49 acres, Los Angeles City College was the original location for UCLA before it moved to Westwood, CA. The college facilities include more than a dozen multistory classroom buildings including a library, computer labs, fitness centers, theatre, and TV/film studios.

Through a \$147 million bond award, the college is further enhancing itself with a new and advanced technology learning facility, increased parking, and expanded athletic/fitness and child development centers. (Note: LACC does not provide campus housing. However, inexpensive rentals are available in the surrounding community.)

Our student body is one of the most diverse in the country. Students range in age from late teens to seniors and come from every ethnic group, culture and country in the world. We are proud to have ranked 35th among all community colleges across the country in awarding 2-year certificates to students; 33rd in awarding associate degrees to minority students; and 23rd in awarding associate degrees to Hispanic students. (Community College Week, June 24, 2002, On-line Edition.)

SATELLITES

City College at Wilshire

<http://www.lacitycollege.edu/offsite/ccw>

City College at Wilshire, CCW, is located on the 2nd floor of the 3020 Wilshire Boulevard building, two blocks east of Vermont Ave. - (323) 953-4000 ext. 2230 or (213) 805-4230.

Northeast Campus: Fletcher & San Fernando Rd./Atwater Village Currently under construction, this satellite location includes the historic Van de Kamp Bakery building, now under restoration.

We also offer distance learning (taking classes via computer and/or video) through Instructional Television and on-line courses.

HISTORY

Los Angeles Junior College was established on September 9, 1929, by the Los Angeles Board of Education. Dr. William H. Snyder served as the institution's first director. During its first year, we offered only first-semester courses. The "semi-professional courses" were for students who wanted to limit their college education to two years, and the "certificate courses" were for those looking to continue toward university work. There were more than 1,300 students taught by some 54 faculty. The first Associate in Arts degrees were conferred June 19, 1931.

Governance of LACC has changed through the years. Until 1931, it was a division of the Los Angeles Secondary School District. In 1931, the electorate voted to establish a separate Los Angeles Junior College District. In 1938, the Board of Education changed the name to Los Angeles City College. In July 1969, the California State Legislature enacted legislation allowing the separation of the nine-campus Los Angeles Community College District from the Los Angeles Unified School District. A seven-member Board of Trustees was elected and formally assumed governance. (The other eight colleges in the LACCD are: East Los Angeles College; Los Angeles Harbor College; Los Angeles Mission College; Pierce College; Los Angeles Trade-Technical College; Los Angeles Valley College; Los Angeles Southwest College; and West Los Angeles College.)

The chief executive officers of Los Angeles City College since its founding have been:

Dr. William H. Snyder, Director	1929-1934
Dr. Rosco C. Ingalls, Director	1934-1945
Dr. Einar W. Jacobsen, President	1946-1948
Dr. Howard S. McDonald, President	1949-1955
Dr. John Lombardi, President	1955-1966
Dr. Glenn G. Gooder, President	1966-1970
Dr. Louis Kaufman, President	1970-1973
Dr. John H. Anthony, President	1973-1977
Dr. Stelle Feuers, President	1978-1989
Dr. Edwin Young, President	1989-1991
Mr. Jose L. Robledo, President	1991-1997
Dr. Mary Spangler, President	1997-2003
Dr. Doris Givens, President (Interim)	2003-2005
Dr. Steve Maradian	2005-2008
Dr. Jamillah Moore	2008-Present

DISTRICT PHILOSOPHY

The Los Angeles Community College District (LACCD) affirms the principle that individuals should have opportunities to develop to their full potential. To that end, our main responsibility is to students and to providing an education that benefits students and enables them to contribute to society. The LACCD colleges, therefore, should be accessible to all individuals who have the capacity and motivation to profit from higher education. Curricula and services of our colleges should provide means for fulfilling the promise of open access.

We recognize the necessity to adapt to the changing educational needs of the LACCD communities and to the growing diversity among students. The quality of the educational experience is judged by its value to students and communities, not merely by quantitative appeal. We further recognize that academic freedom is essential to excellence in education.

The mission of the LACCD colleges is to provide comprehensive lower-division Transfer Education, Occupational Education, General Education, Transitional Education, Counseling and Guidance, Student Services, Continuing Education, Community Services, and Joint Programs that are appropriate to the communities served and that meet the changing needs of students for academic and occupational preparation, citizenship, and cultural understanding.

In pursuit of this mission, we endeavor to:

- promote equal opportunity for participation;
- maintain appropriate standards for academic achievement;
- provide an educational environment that meets the needs of students with varied learning skills;
- provide support services that contribute to instructional effectiveness and student success;
- affirm the importance of multi-cultural, international, and inter-cultural collegiate experiences that foster individual and group understanding; and
- manage effectively educational and financial resources.

FUNCTIONS OF THE LACCD COLLEGES

To accomplish the educational philosophy and mission of the Los Angeles Community College District, Los Angeles City College offers the following types of educational programs.

- **Transfer.** A college program that enables the student who completes two years of study to continue upper division (third year) work at accredited four-year colleges and

universities through careful and continuous articulation with accredited collegiate institutions and high schools.

- **Occupational.** An occupational education program planned to offer the student basic business, technical, and professional curricula to develop skills that can lead to employment, job advancement, certification, or the Associate degree.
- **General Education.** A program of General Education course work consisting of Associate degree programs and other planned experiences that develop knowledge, skills, and attitudes necessary for the student to be effective as a person, a family member, a worker, and a citizen, thereby enhancing the quality of life for the individual and for the society at large.
- **Transitional Education.** A program of remedial and basic skills education for students needing preparation for community college.
- **Continuing Education.** A program of continuing education consisting of graded and ungraded classes to provide opportunities for personal and occupational competence that supplements formal full-time college attendance.
- **Counseling and Guidance.** A counseling and guidance program incorporating academic, career, and personal counseling to assist the student in the establishment of educational goals and in the selection and pursuit of a life work compatible with his or her interests, aptitudes, and abilities.
- **Student Services.** A student services program assisting students in matters of admissions, financial aid, job placement, matriculation and other related student services activities.
- **Community Services.** A program of not-for-credit classes offered to meet the needs of the community for vocational and recreational courses, community and cultural events, and civic functions, completely financed by fees charged those attending the classes.
- **Joint Programs.** Joint programs with business, industry, labor, education, government, international and other institutions that are of mutual benefit to sponsoring institutions, enhance the educational opportunities of program participants, and advance the mission and functions of the LACCD.

ACCURACY STATEMENT

The Los Angeles Community College District and Los Angeles City College have attempted to make this catalog accurate and may, without notice, change general information, courses, or programs offered. The reasons for change may include student enrollment, level of funding, or other issues decided by the District or college. The District and college also reserve the right to add to, change, or cancel any rules, regulations, policies and procedures as provided by law.

ACCREDITATION & PROFESSIONAL PROGRAM APPROVALS

Los Angeles City College, a California public, tax-supported community college, is accredited by the Accrediting Commission for Community and Junior Colleges of the Western Association of Schools and Colleges (3402 Mendocino Avenue, Santa Rosa, CA, 95403; [707] 569-9177), an institutional accrediting body recognized by the Commission on Recognition of Postsecondary Accreditation and the United States Department of Education.

Los Angeles City College programs are also accredited by the

American Dental Association (Dental Laboratory Technician) and the American Medical Association (Radiologic Technology) and the Commission on Dietetic Education of the American Dietetic Association (Dietetic Technician).

STUDENT RIGHT-TO-KNOW DISCLOSURE

Beginning in Fall 1995, all certificate, degree, and transfer-seeking first time full-time students were tracked over a three-year period; their completion and transfer rates were calculated. More information about Student Right-To-Know rates and how they should be interpreted can be found at the California Community Colleges "Student Right-To-Know Information Clearinghouse Website" at <http://srk.cccco.edu>. Student Right To Know: Campus Security.

EQUAL-OPPORTUNITY POLICY COMPLIANCE PROCEDURE

To assure proper handling of all equal opportunity matters, including the Civil Rights Act and Americans with Disabilities Act, discrimination, accommodation, and compliance issues, inquiries should be directed to following individuals:

Compliance Officer

- Sexual Harassment
- Discrimination – Education
- Discrimination – Workplace - Hiring/Promotion
- Training

For assistance, contact the Compliance Officer (323) 953-4000 ext. 2249.

- ADA Section 504

For assistance, contact the ADA Coordinator in AD 208C, (323) 953-4000 ext. 2249.

Administrative Services for Affirmative Action

- EEO – Hiring/Promotion
- Gender Equity (Non-Athletic)

For assistance, contact Lenore Saunders, Administrative Analyst, AD 213 (323) 953-4000 ext. 2094.

PROHIBITED DISCRIMINATION & HARASSMENT POLICY

The policy of the Los Angeles Community College District is to provide an educational, employment and business environment free from prohibited Discrimination, as defined by Rule 15003. Employees, students, or other persons acting on behalf of the District who engage in Prohibited Discrimination as defined in this policy or by State and Federal law shall be subject to discipline, up to and including discharge, expulsion, or termination of contract. The specific rules and procedures for reporting allegations of Prohibited Discrimination and for pursuing available remedies are incorporated in the Board Rules in Chapter 15. Copies may be obtained from each College and District Compliance Officer.

The LACCD has a policy that provides formal and informal procedures for resolving complaints. Copies of the policy and procedures may be obtained from the LACC Compliance Office Website (www.lacitycollege.edu/resource/compliance office) or by calling the LACCD Office of the Vice Chancellor of Educational Services at (213) 891-2279, or the LACCD Office of Diversity Programs at (213) 891-2315.

Any member of the Los Angeles City College community, which includes students, faculty, and staff, who believes, perceives, or actually experiences conduct that may constitute prohibited discrimination, has the right to seek the help of the College. Every employee has the responsibility to report such conduct to the LACC Compliance Officer when it is directed toward students.

Potential complainants are advised that administrative and civil law remedies, including but not limited to injunctions, restraining orders or other orders, may be made available. For assistance, contact the Compliance Officer, (323) 953-4000 ext. 2249.

LIMITED ENGLISH PROFICIENCY

Occupational Education Classes are open to all students. Although the lack of proficiency in English is no barrier to enrollment in occupational education courses, it is suggested the students deficient in English utilize the services of the college that are provided for persons who are limited in English proficiency or have English as a Second Language.

Contamos con cursos vocacionales en distintas ramas de trabajo. Todos los cursos están disponibles a las personas que no dominan el idioma inglés con fluidez. No tener conocimientos básicos de inglés no debe ser un impedimento para matricularse en dichos cursos. Los servicios del colegio están disponibles para personas que hablan inglés como segundo lenguaje.

Սասնագիտական կրթության դասերը բաց են բոլոր ուսանողների համար: Անգլերենի սահմանափակ տիրապետումը արգելք չի հանդիսանում ընդգրկվելու մասնագիտական դասերի մեջ: Անգլերենից թույլ ուսանողներին առաջարկվում է օգտվել քոլեջի ծառայություններից, որոնք նախատեսված են այն ուսանողների համար, որոնց անգլերենը սահմանափակ է կամ երկրորդ լեզուն է ՌՐՍԼԶ:

ALTERNATIVE PUBLICATION FORMATS

Students with verifiable disabilities who require alternate formats of college publications and resources should check with The Vice President of Student Services (323) 953-4000 ext. 2460. The College will provide information in alternate text formats upon request in the timeliest manner possible. Note: the Catalog and Schedule of Classes are also available on our web site, www.lacitycollege.edu.

CAMPUS SECURITY REPORTS

Pursuant to the Clear Act, the College's Security Reports are published in each LACC class schedule and on the web at www.lacitycollege.edu/public/Crime/index.htm. Students may obtain a paper copy of the Report upon request from the Sheriff's office.

[lacitycollege.edu/public/Crime/index.htm](http://www.lacitycollege.edu/public/Crime/index.htm). Students may obtain a paper copy of the Report upon request from the Sheriff's office.

STUDENT RESPONSIBILITIES TO BE INFORMED

It is the student's responsibility to be familiar with the information presented in this catalog and to know and observe all policies and procedures related to the program he or she is pursuing. Regulations will not be waived and exceptions will not be granted if a student pleads ignorance of policies or procedures.

While LACC academic counselors are available to assist you in planning your schedule, and other instructors are available to assist you, it remains the responsibility of the student to follow all policies and to meet all requirements and deadlines. Students need to satisfy the requirements of the catalog in effect at the time he or she is admitted to, and begins course work in, a degree or certificate program. If a student is not in attendance for more than one consecutive semester, he or she must follow the catalog in effect when they return. New catalogs take effect in the Fall semester of the year published.

CATALOG RIGHTS

The college catalog is the document of record. A student will maintain "catalog rights" by continuous* attendance in the Los Angeles Community College District to satisfy the degree, certificate or graduation requirements in effect at the college from which the student will earn the degree, certificate or graduate if:

1. At the time the student began such attendance at the college, or
2. At the time of graduation.

* Continuous attendance means no more than a one semester absence within a school year, excluding summer sessions and winter inter sessions. Absence due to an approved educational leave shall not be considered an interruption in attendance, if the absence does not exceed two years.

For purposes of implementing this policy, the college may:

1. Authorize or require substitutions for discontinued courses; or
2. Require a student changing his/her major to complete the major requirements in effect at the time of the change.



ADMISSIONS INFORMATION

ACADEMIC YEAR

The academic year is divided into 4 sessions:

Fall Semester	(15 weeks, August - December)
Winter Inter session	(5 weeks, January - February)
Spring Semester	(15 weeks, February - June)
Summer Session	(5 & 8 week sessions, June - August)

Courses offered during these sessions are similar in scope and maintain equivalent standards. Students may enroll concurrently at Los Angeles City College in both day and evening classes. Days, Evening, Weekends & Distance Learning Classes

Days, Evening, Weekends & Distance Learning Classes

Classes are taught from 7:00 a.m. to 10:00 p.m., Monday through Friday and 7:00 a.m. to 5:00 p.m. on Saturdays. Some courses are available through distance learning including Instructional Television (ITV) and on-line.

Summer Sessions:

Los Angeles City College offers one or more 5 to 8 week summer sessions subject to approval by the Board of Trustees.

ELIGIBILITY REQUIREMENTS

Individuals who possess a high school diploma or its equivalent meet the basic eligibility requirement for admission to any public California two-year community college, including Los Angeles City College.

Individuals who do not possess a high school diploma or its equivalent but who meet additional criteria are also eligible for admission to LACC if in the judgment of the College Admissions Officer they are capable of profiting from the instruction offered.

Additional eligibility criteria include persons who are:

1. Eighteen years of age.
2. Apprentices, as defined by Section 3077 of the California labor Code.
3. In grades K-12, under special circumstances. Information regarding other eligibility criteria and/ or admission procedures is available in the Office of Admissions and Records.

CALIFORNIA RESIDENCY REQUIREMENT

To attend any of the Los Angeles Community College District colleges as a resident of California, a student is required to have been a California resident for more than one year preceding the Residence Determination Date. The "Residence Determination Date" is that day preceding the opening day of instruction of the semester.

NON-RESIDENT

A non-resident student is one who has not had residence in the State of California for more than one year immediately preceding the Residence Determination Date.

A student classified as a non-resident will be required to pay non-resident fees as established by the LACCD Board of Trustees. Residence Reclassification Students who have been classified as non-residents must petition to be reclassified as residents anytime they feel their status has changed. The Residence Reclassification form is available in the Office of Admissions in the Administration Building (AD100) and must be submitted before the semester in which reclassification as a resident is to be effective.

RESIDENCE APPEAL

A student may appeal the residence classification determined by the College. The student must make the appeal within 30 calendar days of receipt of notification of the residence classification from the Admissions Office. The appeal must be submitted in writing to the College Admissions Officer, who is located in the Administration Building (AD100). You may also contact the Office of Admissions (323) 953-4000, extension 2104.

NON-CITIZEN STUDENTS

Los Angeles City College is authorized under Federal and State law to enroll non-citizen students. Information regarding admission procedures is available in the Office of Admissions in the Administration Building (AD100). You may also contact the Office of Admissions (323) 953-4000, extension 2104.

APPLICATION FOR ADMISSION TO LACC

Admissions applications are available online at www.lacitycollege.edu. Application forms are also available at the Student Assistance Center.

The Los Angeles Community College District is committed to protecting student privacy. The social security number will no longer be used as the student identifier for students. New students will be issued a student ID number at the time of application. Every student ID will begin with the numbers "88".

INTERNATIONAL STUDENTS

Also see the "Services & Programs - International Student Center" section of this catalog.

Los Angeles City College has one of the most diverse campuses in the country with students of every culture and from all over the world. The college is certified by the Immigration and Naturalization Services (INS) to issue I-20's to non-immigrant visa students.

Effective April 12, 2002, the Immigration and Naturalization Service has issued an Interim Rule which requires students with B-visas to change their visa status to either a F-1 or M-1 non-immigrant visa prior to pursuing a course of study at the College.

You may be considered if you meet the following requirements:

- Have or will earn a high school diploma from a US high school or the equivalent education from a foreign school.
- Have a score of four-hundred-fifty (450-paper based / 133-computer based/45-internet based/) or more on the TOEFL (Test of English as a Foreign Language).
- Have a valid non-immigrant visa.
- Show the ability to pay the non-resident tuition.

If you live in the Los Angeles area and would like to be considered for admissions:

- 1) Attend a scheduled meeting
- 2) Take the College Placement Assessment to determine placement in English

For meeting dates & times or for more info.: (323) 953-4000 ext. 2470.

For information on receiving credit for courses taken in universities outside of the U.S., see the "Policies - Academic" section of this catalog.

REGISTERING FOR CLASSES

NEW & RETURNING STUDENTS:

A new student is one who has never taken classes at Los Angeles City College and has filed an Application for Admission. A returning student is one who has had a break of more than two semesters between enrollments at Los Angeles City College.

- Step 1:** Obtain an application from the Student Assistance Center or via the web at www.LACityCollege.edu
- Step 2:** Return completed application to the Admissions Office, AD 100 and receive an assessment appointment in AD 103.
- Step 3:** Complete your skills level assessment and orientation.
- Step 4:** Register for classes by phone or via the web. Students who already have a degree may skip Step 3.

Continuing Students

A continuing student is one who attended classes at Los Angeles City College during one of the previous two semesters. Continuing students will automatically receive their registration appointment dates and time in the mail.

STEP Registration System

Los Angeles City College provides the “Student Telephone Enrollment Program” (STEP) for enrolling. By using the STEP system, students can enroll in Fall, Winter, Spring, and/or Summer classes and access their grade information. Refer to the current Schedule of Classes for more information.

Class Unit Limit

The maximum study load is 18 units for the Fall and Spring semesters, 12 units for Summer when there are 3 Summer Sessions. 7 Summer Units = 7 units and 7 units during a Winter Inter session. While the class load for full-time students in the Fall or Spring semester is from 12 to 18 units per semester, students who will be employed while attending Los Angeles City College should reduce their programs accordingly. It is strongly recommended that students who are employed full-time should enroll in no more than 1 or 2 classes or a maximum of 9 units. Students who wish to attempt more than the unit limits specified above must petition to do so with the Counseling department, located in the Administration Building (AD 108).

Cancellation of Classes

The college reserves the right to discontinue any class with insufficient enrollment prior to the end of the second week of the class.

MATRICULATION

The College Agrees to Provide:

- 1. ADMISSIONS** - Students can complete an admissions application online at www.lacitycollege.edu students can also speak to multilingual student staff member in the Student Assistance Center for assistance in completing the admissions application and receive general campus information with confidential support and referrals (AD 105). Completed applications are turned in to Admissions (AD 100).
- 2. ASSESSMENT** - You will take a basic skills assessment in reading, writing, language usage, and mathematics to help you select courses appropriate for you. Appointments to take assessment are made in AD 103.
- 3. ORIENTATION** - Introduces you to the campus resources, support services and college programs which are available to help you make better, more informed educational and career choices.

4. COUNSELING - Provides academic advisement and assistance in course selection, development of a Student Educational Plan, career planning, referral to appropriate student services, and Personal Development Classes which are taught by counseling faculty.

5. FOLLOW-UP - Provides regular evaluation of your progress through the Early Alert program and group counseling sessions.

The Student Agrees to:

- Express at least a broad educational intent upon admission.
- Declare a specific educational goal after completion of 15 semester units at the college.
- Meet with a College Counselor to establish a Student Educational Plan within one semester after declaring an educational goal and to review the Educational Plan at least once each semester.
- Attend classes regularly and complete assigned course work.
- Maintain satisfactory progress toward an educational goal according to standards established by the Los Angeles Community College District and the State of California.
- Be familiar with the information in the college catalog and schedule of classes, and know and observe all policies and procedures related to the program of study being pursued.

Exemption

As a student, you may be exempted from matriculation if you meet at least one of the following criteria:

- Have an AA, BA or higher degree from an accredited college or university.
- Have completed 30 units or more including English 28 or 101 and Mathematics 115 or equivalent courses.
- Are enrolling for personal enrichment or recreational purposes without plans of taking more than 15 units of credit classes.

Even if you are not exempted from matriculation you may be exempted from assessment if you meet any of the following criteria:

- Have a record of completing English 28 or 101 and Mathematics 115 or equivalent courses.
- Have completed equivalent assessments at other colleges and have presented their documentation for verification to the Assessment Center, AD 103. (Verification must be presented before an exemption can be granted.) Math assessment is accepted up to one year.

Waiver

If you are not exempt from matriculation but choose not to participate in the process, a waiver is available in the Student Assistance Center, AD 105. The exemption waiver must be taken to the counseling Office, AD 108, for approval.

Appeal

Matriculation is a campus-wide effort of faculty, administrators, staff and students. However, if for any reason, you feel that matriculation interferes with your rights as a student, forms for appeal are available in the Office of the Vice President of Student Services, AD 207.

PREREQUISITES/CO-REQUISITES, ADVISORIES & CHALLENGES

The following explains conditions of enrollment that qualify a student for a class or course of study according to laws and state regulations AB3 and Title 5.

Prerequisite is the requirement needed to qualify for a course. It is designed to identify skills necessary for success in a course.

Co-requisite is the requirement for taking a simultaneous course in order to enroll in a particular class.

Advisory is advice given before enrolling. It is not required that a student follow this advice.

A Satisfactory Grade is an academic record with the symbol A, B, C, or "P."

CHALLENGE POLICY/PROCEDURE

A student may challenge the above enrollment policies by filing a Prerequisite or Co-requisite Challenge Petition. You can obtain the form from the Admissions Office (AD 100), the Student Assistance Center (AD105), or the Counseling Center (AD 108). Documented proof of your challenge will be required. The Petition must be filed with the Department Chair of the department over the class that is being challenged. If the College does not resolve your challenge within the five-day period, you will automatically be enrolled in the class. If no space is available in the class, the challenge shall be resolved before the beginning of registration for the next term. If your challenge is upheld and space is available, you may enroll in the next term.

Grounds for Challenges

It is your responsibility to show proof with documentation that you have grounds for a legitimate challenge. You may challenge any of the prerequisites or co-requisites using any of the Title 5 regulations listed below:

NOTE: If you have successfully completed a similar course outside of the Los Angeles Community College District, bring your official or unofficial transcripts or grade cards to the Counseling Office - AD 108 for evaluation.

1. The prerequisite/co-requisite does not follow the rules established by the District.
2. The prerequisite/co-requisite is in violation of Pre/Co-requisite and Advisory Regulation, specified in Section 55201(e) of Title V. (See Office of the Vice President of Student Services - AD207)
3. The prerequisite/co-requisite is unlawfully discriminatory or being applied in an unlawfully discriminatory manner. Once you have completed the prerequisite or co-requisite Challenge petition process on the grounds of unlawful discrimination, you have the right to file a formal complaint of unlawful discrimination with the Compliance Officer.
4. You have the ability and knowledge to succeed in a course without the pre/co-requisite.
5. You will be subject to undue delay in obtaining your educational goal because the prerequisite/co-requisite course was not reasonably available.
6. You have not been allowed to enroll due to a limitation set for a course that involves intercollegiate competition, public performance, honor courses, or blocks of courses limited to a particular group of students. You will be allowed to enroll in such a course if there is no equivalent section offered, and you would be delayed

a semester or more in obtaining your degree or certificate specified in your Student Educational Plan.

7. You want to enroll in a course which has prerequisite/co-requisite established to protect health and safety, and you can demonstrate that you do not pose a threat to yourself or others.

Resolution of Prerequisite Challenges

Each prerequisite challenge shall be investigated and resolved through the appropriate department chair no later than five (5) working days from the day that your challenge is filed.

Pre/Co-requisite Challenge Petition Filing Dates

Students may file challenges throughout the fall and spring semesters up to five (5) working days before the end of each semester. Some departments may accept petitions during summer session and winter intersessions, based on faculty availability.

TUITION & FEES

Note: the fees listed below were accurate at the time this catalog went to print in Sept. 2008, but are subject to change by the California Legislature. Fees are due at the time of registration and create a hold until paid in full.

Students may pay fees by cash, check, Visa, MasterCard, American Express or Discover Card. If you pay your fees by check, your student ID number will be written on your check. If you do not wish to have your student ID number appear on your check, you must use an alternative form of payment. \$10 handling fee is charged on all returned checks. Fees may be paid online at http://www.laccd.edu/student_information/sis_logon.asp or on the STEP telephone system, via credit card.

ENROLLMENT FEE \$20 per unit

(CA Residents) (no maximum per semester)
Section 72252 of the Education Code requires Los Angeles City College to charge an enrollment fee of each student enrolling in college. The fee is twenty six dollars (\$26) per unit per semester for resident students. This fee must be paid at the time of registration. Students may pay enrollment fees by cash, check, or VISA, MasterCard, American Express or Discover Card.

If at the time of enrollment you are receiving benefits under the Temporary Assistance for Needy Families (TANF), the Supplemental Security Income/ State Supplementary Program, or the General Assistance Program, the enrollment fee will be waived. For information on the procedure for requesting a waiver, contact the Financial Aid Office before you enroll at LACC.

Financial aid may be available to students who meet the qualification requirements. Students with questions concerning financial aid eligibility should contact the LACC Financial Aid Office. Students should submit an application as soon as possible.

NON-RESIDENT TUITION FEE

Out-Of-State Residents \$181 per unit
Foreign Citizens \$191 per unit

Non-resident foreign citizens must also pay the enrollment fee of \$20 per unit. Effective for the winter 2009 term, students who take 4 or fewer units, OR who take one class that is more than 4 units but is not more than 6 units, will have their non-resident tuition waived. A student who exceeds these limits will be required to pay non-resident tuition for ALL units, unless the student is eligible for an AB 540 waiver.

Enrollment Fee Assistance

Los Angeles City College offers enrollment fee assistance to eligible students who need assistance in paying the enrollment fee. The Board of Governors (BOG) Enrollment Fee Waiver is available to students whose family is receiving Temporary Assistance for Needy Families (TANF)/CalWORKS, Supplemental Security Income/State Supplemental Program, General Assistance/General Relief, or who meet the qualifying income standards. In addition, dependents of Veterans/National Guard, Congressional Medal of Honor recipients and their children, victims of the September 11, 2001 terrorist attack and deceased law enforcement/fire suppression personnel killed in the line of duty, are also eligible for fee waiver.

An Automatic Fee Waiver will be processed for eligible California residents who have filed a Free Application for Federal Student Aid (FAFSA) with the College Financial Aid Office. Students may contact the Financial Aid Office to obtain a Board of Governors Fee Waiver (BOGFW) Application.

See Board of Governor's Fee Waiver Program under "Financial Aid - State Financial Aid."

Enrollment Fee Refunds

CA Residents: For full-session classes, a full refund of the enrollment fee will be made through the end of the second week of classes. For short-term classes, a full refund is available up to the end of a period equal to ten percent (10%) of the total session length. No refund will be authorized after the periods described above except when college action to cancel or reschedule a class necessitates the drop. Students must request check/credit card refunds in the Business Office. Credit card refunds will be processed a week after filing the request.

NOTE: After the second week, fees for dropped classes will be applied to fees for classes added simultaneously or after a drop. No refunds will be given for drop transactions alone. Students are strongly advised to complete add and drop transactions simultaneously, within the authorized dates for doing so.

Non-Residents: Non-resident students who formally drop or otherwise separate from part or all of their enrollment may request a refund of previously paid non-resident tuition and enrollment fees in accordance with the following schedule and computations, calculated as follows:

Instructional Materials Fee

Students may be required to provide instructional and other materials required for credit or no-credit courses. Such materials shall be of continuing value to a student outside the classroom setting and shall not be solely or exclusively available from the Los Angeles Community College District.

Associated Student Organization (ASO) Fee \$7 per semester

A \$7 per semester membership fee provides access to the ASO Services Center where you can receive free bluebooks, scantrons, copier and fax services, use the computers for homework or to access the internet, preferred parking, movie and amusement park discounts, etc. You are also eligible to participate in student government; join a club; support the college's theater, music and forensic programs; attend campus events; and participate in shared governance.

Student may waive the ASO benefits by completing the waiver form. Waiver forms can be obtained from the Office of Student Life, located in the LRC.

Student Representation Fee \$1 per semester

This required fee benefits LACC students by enabling your ASO to respond to legislative issues which impact students directly, i.e. tuition increases, textbooks taxes, community college funding. The ASO advocates and lobbies on your behalf at the District or in Sacramento and coordinates their efforts with the state and regional community college student organization (California Student Senate). The ASO is your

legally designated liaison with the college, the District Office, the California State Chancellor's Office and the Board of Governors. They represent the LACC student before local, state and federal government organizations.

Health Services Fee \$11 per semester

The Los Angeles Community College District charges an eleven dollar (\$11) mandatory Health Fee. The fee is payable to one campus only and covers the costs of Health Centers at the District's nine campuses. If you are a member of a religious group that depends on prayer for healing, please contact the Dean of Special Services, in CH109 for exemption procedures. Also see Policies: General "Student Health Fee Waivers."

Parking Fee

Parking in campus lots in areas marked "Parking by Permit Only" will be restricted to vehicles displaying a valid permit. Permit procedures, fees, and refund information are available in the Business Office. A limited number of parking permits will be sold.

Summer Permits: \$10

Winter Permits: \$10

Fall or Spring: Restricted Parking \$20 (Lot #2 parking structure ONLY). Preferred Parking \$27 (Lot #1 ground floor open area, Lot #2 & #3 parking structures, AND ASO membership).

WHAT IS FINANCIAL AID?

Financial Aid is monies made available by federal and state governments and by private sources in the form of grants, scholarships, loans, and employment. This assistance makes it possible for students to continue their education beyond high school, even if they and/or their family cannot meet the full cost of the postsecondary school they choose to attend.

Who Is Eligible For Financial Aid?

To be considered for financial aid, students must generally meet the following minimum requirements:

- Be a U.S. citizen or an eligible non-citizen. An eligible non-citizen is a U.S. permanent resident who has documentation from the Department of Homeland Security verifying that his/her stay in the U.S. is for other than a temporary purpose.
- Show financial need.
- Be making satisfactory academic progress in a course of study leading to an AA or AS degree, certificate, or transfer to a baccalaureate degree program.
- Not be in default on any loans such as Federal Perkins Loans, Federal Stafford Loans (subsidized and unsubsidized), Federal Direct Loans (subsidized and unsubsidized), or FPLUS Loans (Parental Loans for Undergraduate Students) at any school attended.
- Not owe a refund on a Federal Pell Grant, Federal Supplemental Educational Grant (FSEOG), or Cal Grant programs.
- Be registered with the Selective Service, if male between the ages of 18 and 26 years old.
- Be enrolled as a regular student in an eligible program.
- Have a valid social security number.
- Demonstrate an ability to benefit as defined below:

Ability to Benefit (ATB):

Students who meet one of the qualifications listed below have demonstrated the ability to benefit from a college education in accordance with applicable federal regulations.

- Received a high school diploma; or
- Passed a high school proficiency examination; or
- Received a certificate of General Education Development (GED); or
- Successfully completed a two-year program (minimum 48 credit towards a bachelor's degree); or
- Passed an independently administered Ability to Benefit test that is approved by the Secretary of the Department of Education. ATB Tests are administered and scheduled through the Assessment Center at Los Angeles City College.
- Satisfactorily completed six credit hours or the equivalent coursework applicable toward a degree or certificate offered by the institution of higher education

HOW TO APPLY FOR FINANCIAL AID

To apply for federal and state financial aid programs, complete the Free Application for Federal Student Aid (FAFSA). The FAFSA is an all inclusive form that allows students to apply for all programs. Students applying for Federal Direct Loans, Emergency Loans, or scholarships must complete additional applications and/or forms that may be requested from the Financial Aid Office. FAFSA applications are available at the College Financial Aid Office, high schools, counseling offices, and libraries.

Students may also apply on-line at www.fafsa.ed.gov. Be sure to print and mail the signature page after transmitting the application or apply for a Personal Identification Number (PIN) to electronically sign the application.

Note: Financial Aid applicants must use their own social security number on all college records.

PRIORITY DATES & DEADLINES

In general, students must submit a valid Student Aid Report (SAR) or the institution must have on file a valid Institutional Student Information Record (ISIR) by the last day of enrollment for a term.

- To receive a Pell Grant, financial aid applications and all required documents must be submitted to the Financial Aid Office prior to the end of the enrollment period.
- To receive a Cal Grant, the FAFSA must be submitted no later than March 2, 2009 for the 2009-2010 award year. Students planning to attend a community college in 2008-2009 have a secondary deadline of September 2, 2009 to apply for Cal Grant.
- The priority processing date May 1, 2009, for the 2009-2010 academic year. Students who have missed the priority processing date are encouraged to apply as funds may still be available.
- To receive Direct Loans, the application and/or request form and verification forms, must be processed 20 working days prior to the end of the enrollment period for which the loan is requested.

Consult the LACC Financial Aid Office for more information regarding priority dates.

VERIFICATION

For students selected for verification by the Department of Education, the Financial Aid Office will request additional documents, such as Federal Tax Returns, to process the application.

FEDERAL REFUND REQUIREMENTS

Students who receive federal financial aid and withdraw from ALL classes at the institution in the first 60% of the term may have to repay the "unearned" federal funds received prior to withdrawal. The Financial Aid Office will calculate the amount of federal funds earned up to the point of withdrawal and students will be billed and must repay any federal grant funds received but not earned. Failure to repay these funds will result in the denial of future federal financial aid.

Students are advised to contact the Financial Aid Office before withdrawing from all of their classes.

FEDERAL RECALCULATION REQUIREMENTS

Federal Pell Grant and Federal Supplemental Educational Opportunity Grant (FSEOG) awards must be recalculated if the student's information changes after the initial calculation or disbursement. The three factors that are most likely to change are enrollment status, expected family contribution (EFC), and cost of attendance.

Awards will be calculated during each term, based on the student's enrollment status for that term. If the student's enrollment status changes up to the date of the second disbursement run date, the Financial Aid Office will recalculate the student's Federal Financial Aid Grants. A recalculation may result in a decreased or increased award.

FEDERAL FINANCIAL AID

Federal Pell Grants - The Federal Pell Grant is a federally funded program. To be eligible, an applicant must be an undergraduate student and demonstrate financial need. Grants range from \$976 to \$5,350 per academic year.

Federal Academic Competitiveness

Grant (ACG) – The ACG is a federal program intended to encourage rigorous academic study in high school. A student may receive an ACG award only in the first and second academic years. The ACG grant has set value of \$750 for the first year and \$1,300 for the second year.

Federal Supplemental Educational Opportunity

Grants (FSEOG) – The FSEOG is a federal grant program designed to supplement other sources of financial aid for students with exceptional need.

Federal Work Study (FWS)—FWS enables a student to earn part of his/her financial aid award through campus employment.

Federal Perkins Loan—This is a low interest loan made available to students with exceptional need to meet their educational expenses.

Federal Direct Loans (Subsidized and Unsubsidized) – Students may be eligible to borrow up to \$3,500 for first year students and \$4,500 for second year students per academic year from the Direct Loan Program. The student's annual borrowing limit may also vary based upon the following:

- The amount of unmet need after other federal assistance is considered; and
- The applicant’s aggregate student loan debt; and
- The applicant’s previous delinquent or defaulted loan history.

NOTE: Los Angeles City College will be unable to certify additional loans for a student who has already borrowed two years worth of loans including loans borrowed at other institutions, until the student has obtained additional loan counseling.

Bureau of Indian Affairs Grants (BIA) – The Bureau of Indian Affairs grants provide money to help defray the costs of education for students with American Indian heritage. Students may apply if they:

1. A member of, or at least one-quarter American Indian blood or a descendent of a member of an American Indian tribe who are eligible for the special programs and services provided by the United States through the Bureau of Indian Affairs to Indians because of their status as Indians.
2. Have been accepted for admission to a nationally accredited institution of higher education that provides a course of study conferring the Associate of Arts or Bachelor’s degree.
3. Demonstrate financial need as determined by the financial aid officer of the post-secondary institution.

To obtain an application, please send your request to the Office of Indian Education Program, 2800 Cottage Way, Sacramento, California 95825 or call (916) 978-6058.

**STATE FINANCIAL AID
Board of Governor’s Fee
Waiver Program (BOGFW):**

Under this program enrollment fees are waived for students who meet qualification criteria. Applicants do not have to be enrolled in a specific number of units or courses to receive the waiver and no repayment of funds is required. California residents who are enrolled in at least one (1) unit may apply for a fee waiver.

There are three ways to qualify:

At the time of enrollment you are a recipient of benefits under the TANF/CalWORKS Program (formerly AFDC), SSI (Supplemental Security Income), General Assistance (also known as General Relief).

1. You meet the following 2008 income standards.

Household Size (including yourself)	Total 2008 Family Income (adjusted gross income and/or untaxed income)
1	\$15,600
2	\$21,000
3	\$26,400
4	\$31,800
5	\$37,200
6	\$42,600
7	\$48,000
8	\$53,400

In addition to the income standards, students may also demonstrate BOGFW B eligibility by having a zero EFC (Expected Family Contribution) under federal methodology. The student is also eligible if the parent portion of the EFC is zero or less.

2. You qualify for financial aid. If you qualify under the criteria, you will need to complete the FAFSA. If you qualify after

you have paid your enrollment fees, you should complete a “Request for Refund” form available in the college Business Office.

CAL GRANT PROGRAMS

- **Cal Grant A** – Although Cal Grant A is only for use at a four-year college, students should apply while attending Los Angeles City College. The California Student Aid Commission (CSAC) will reserve grants for students who qualify until they transfer to a four-year college, but will not hold them for more than two years.
- **Cal Grant B** – Cal Grant B provides a living allowance for entering college freshman who come from very low income families. At a community college, grants can range from \$300 to \$1551 per academic year. Students must be enrolled in a minimum of six (6) units to be eligible.
- **Cal Grant C** - Cal Grant C is intended for students who desire to train for specific occupations, vocations, or technical careers, but who do not have the financial resources to enter training programs because they are from low income families. Grants are limited to \$576 per year at community colleges for programs ranging in length from four months to two years. Students must be enrolled in at least six (6) units and demonstrate occupation achievement or aptitude in the chosen field.

Chafee Grant Program

The California Chafee Grant Program gives up to \$5,000 annually of free money to foster youth and former foster youth to use for college courses or vocational school training. The student must be enrolled in an eligible college or vocational school, enrolled in at least half-time and an eligible course of study that is at least one year long. To get additional information, please contact the California Chafee Grant Program at 1-888-224-7268 or write to California Student Aid Commission, Specialized Programs, Attn: California Chafee Grant Program P.O. Box 419029 Rancho Cordova, CA 95741-9029.

**Law Enforcement Personnel Dependents
Scholarship**

This grant program provides educational benefits to the dependents of California police and other law enforcement officers (Chief of Police, Police Officers, Sheriffs, Marshals, Deputy Marshals, etc.) who have been killed or totally disabled in the line of duty. For more information and application materials, write directly to: California Student Aid Commission, 1515 S. Street, Suite 500, P.O. Box 510624, Sacramento, California 94245 – Attention: LEPD Program.

Determining Financial Need

The type of financial aid and amount received will be determined by the LACC Financial Aid Office. Financial aid awards are based on demonstrated financial need which is the difference between allowable educational expenses and the expected family contribution (EFC) and/or the student’s resources. Resources may include, but are not limited to employment earnings, veteran benefits, Social Security benefits, TANF/CalWORKS benefits, JTPA benefits, and CARE benefits. Expected family contribution and resources are then measured against the institutional student Cost of Attendance to determine financial need.

2009-2010 Cost of Education: Living at Home

	9 Months	12 Months
Fees	\$542*	\$810
Books & Supplies	\$1,638	\$2,457
Room & Board	\$4,338	\$5,784
Transportation	\$1,044	\$1,392
Personal Expenses	\$3,096	\$4,128
TOTAL	\$10,658	\$14,571

2009-2010 Cost of Education: Living Away From Home

	9 Months	12 Months
Fees	\$542*	\$810
Books & Supplies	\$1,638	\$2,457
Room & Board	\$10,872	\$14,496
Transportation	\$1,170	\$1,560
Personal Expenses	\$2,826	\$3,768
TOTAL	\$17,048	\$23,091

* Subject to change without notice by the California Legislature.

1. Non-Resident Tuition is added to fees, depending on the student residence code.
2. Dependent/Child Care is provided to students requiring child care up to a maximum of \$1,000. A student with a spouse attending the same school will receive one child care allowance per family.

SATISFACTORY ACADEMIC PROGRESS POLICY

I. GENERAL INFORMATION

A. Effective July 1, 2009, Los Angeles Community College District has adopted a new Satisfactory Academic Progress (SAP). In accordance with the Higher Education Act of 1965, as amended, the Los Angeles Community College District (hereinafter referred to as LACCD) established the following Standards of Academic Progress. These Standards apply to all students who apply for and receive financial aid from the programs listed below.

1. Federal Pell Grant
2. Federal Supplemental Educational Opportunity Grant (FSEOG)
3. Federal Work Study (FWS)
4. Federal Perkins Loan
5. Federal Nursing Loan
6. Federal Family Educational Loan (FFEL)
7. Federal Direct Student Loan (FDSL)
8. Cal Grant B and C Child Development Grant

B. Professional Judgment may be exercised in applying these standards in accordance with Section 479A of the Higher Education Act of 1965 As Amended Through June 1994.

C. Satisfactory Academic Progress Standards are reasonable if they are the same as or stricter than the institution's standards for a student enrolled in the same educational program who is not receiving assistance under Title IV Federal Financial Aid Programs.

D. Current and previous coursework earned at any college within the LACCD will be reviewed for compliance with the standards put forth in this policy.

E. Consortium Classes

1. All classes throughout the LACCD will be included when reviewing satisfactory academic progress.
2. For students aided under a consortium agreement with colleges outside the LACCD, consortium classes will be included during satisfactory academic progress review by the home school (the college that processes the student's aid).

II. GENERAL REQUIREMENTS

A. Students receiving financial aid must be enrolled in an eligible program. An eligible program is defined as:

1. An educational program that leads to an associate degree, or
2. An educational program which is at least a two-year academic transfer program that is acceptable for full credit toward a bachelor's degree, or
3. An educational program which is at least a one-academic-year training program that leads to a certificate, degree, or other recognized educational credential and that prepares a student for gainful employment in a recognized occupation

III. SATISFACTORY ACADEMIC PROGRESS STANDARDS

A. Maintenance of a 2.0 cumulative GPA.

B. Fewer than ninety (90) attempted units for students who indicated AA degree or Transfer as their educational goal.

1. ESL and Basic Skills/Remedial classes are excluded from the ninety (90) unit limit when determining units attempted.
2. Students who have already earned an Associate or higher degree will need to follow the appeal procedure.
3. In Progress (IP) grades count as attempted units in the maximum time frame only. It does not affect cumulative grade point average in the qualitative measure nor is it included as completed units in the quantitative measure.

C. Completion of 67% cumulative units attempted.

1. Entries recorded in the students' academic record as Incomplete (INC), No Credit (NCR), and/or Withdrawal (W) are considered non-grades and must be 33% or less than the cumulative units attempted.

APPLICATION OF STANDARDS

A. Satisfactory academic progress for financial aid students will be determined annually at the beginning of the academic year.

B. Students who are disqualified from financial aid will be notified by mail and receive the procedure for appeal.

C. A student who has been disqualified at any college in the LACCD, is disqualified at all colleges within the LACCD.

- D. A change of one (1) educational goal or major course of study will be permitted. Students are eligible to receive financial aid for one educational goal at the institution of attendance.
- E. Disqualification
 - 1. Students will be disqualified if they have one or more of the following academic deficiencies at the end of Spring semester:
 - a. Total units attempted (excluding ESL and Basic Skill/Remedial classes) are equal to or greater than ninety (90) - Associate or higher degree has been earned.
 - b. Cumulative GPA is less than 2.0;
 - c. Cumulative Non-Grades are more than 33%;
- F. Warning Probation Letter
- G. 1. Students will receive a Warning Probation Letter at the end of the Fall semester if they have one or more of the following academic deficiencies:
 - a. Cumulative GPA is less than 2.0;
 - b. Cumulative non-grades are greater than 33%;
- H. Advisory Letter
 - 1. Number of units attempted reaches forty-five (45).

IV. MAXIMUM TIME LENGTH

- A. Students attending for the purpose of obtaining an Associate of Arts Degree (AA), an Associate of Science Degree (AS), or completion of requirements for transfer to a four year college, are allowed 90 attempted units in which to complete their objective.
 - 1. Exceptions will be made only when the requirements of a student’s objective cause the student to exceed the maximum time limit.
- B. Short Length Certificate Programs
 - 1. Some certificate objectives at the Los Angeles Community Colleges may be completed in less time than that required for the Associate of Arts, Associate of Science and Transfer objectives.
 - 2. The following table shows the normal completion time and maximum time for certificate programs of varying length:

Units required for the Certificate Program	Normal Length	Maximum Length
10 to 24	2 semesters	3 semesters
25 to 36	3 semesters	5 semesters
37 to 48	4 semesters	6 semesters

- C. To be eligible for financial aid, a program must be at least six (6) months in length with a minimum of sixteen (16) units. Students enrolled in a certificate program may continue to qualify for financial aid up to ninety (90) attempted units, six (6) full-time semesters, or the equivalent, if they are planning to obtain an A.A. or A.S degree or to transfer to a four-year school in addition to

obtaining the certificate.

V. SUMMER AND WINTER FINANCIAL AID

- A. Summer and Winter terms are included in the evaluation of Satisfactory Academic Progress standards.

FRAUD

Any student who attempts to obtain financial aid by fraud will be suspended from financial aid for unsatisfactory conduct. The college will report such instances to local law enforcement agencies, to the California Student Aid Commission, and/or to the Federal government. Restitution of any financial aid received in such a manner will be required.

SCHOLARSHIPS

Many scholarships are available to Los Angeles City College students. Criteria may include evidence of leadership in various academic departments and/or student activities, citizenship, need, and scholastic ability.

Additional information about scholarships is available through the Financial Aid Office, academic department chairpersons or through the Foundation.

FINANCIAL AID

Clausen Hall 111A • (323) 953-4000 ext. 2025 or ext. 2010 <http://www.lacitycollege.edu/stusvcs/finaid/> For more information, see the Financial Aid section at the beginning of this catalog.

FOUNDATION

Bungalow B3 • (323) 953-4000 ext. 2490 • www.laccfoundation.org

Each year, the LACC Foundation provides students with scholarships and awards to allow them to continue to excel in their educational endeavors. These scholarships vary in their fields, award amounts, and application requirements, including evidence of leadership in various academic departments and/or student activities, citizenship, need, and scholastic ability. Scholarships are the result of the generosity of private donors, LACC alumni and the campus community. Students are encouraged to visit individual department websites and the LACC Foundation site for detailed information regarding available scholarships and awards. All award and scholarship applications normally become available during the beginning of the Spring semester, and are awarded to students towards the end of the Spring semester.

GRADUATION REQUIREMENTS

The Board of Governors of the California Community Colleges has authorized the Los Angeles Community College District Board of Trustees to confer the degrees of Associate in Arts and Associate in Science.

The awarding of an Associate Degree symbolizes a successful attempt on the part of the college to lead students through patterns of learning experiences designed to develop certain capabilities and insights. Among these are the ability to think and to communicate clearly and effectively both orally and in writing, to use mathematics, to understand the modes of

inquiry of the major disciplines, to be aware of other cultures and times, to achieve insights gained through experience in thinking about ethical problems, and to develop the capacity of self-understanding. In addition of these accomplishments, the student should possess sufficient depth in some field of knowledge to contribute to lifetime interest.

LACC CORE COMPETENCIES INSTITUTIONAL LEARNING OUTCOMES (ILO)

These are the skills and abilities graduates of Los Angeles City College are expected to possess.

Area A: ESSENTIAL ACADEMIC SKILLS

1. Information Competency: Critical Creative Thinking
2. Written and Oral Communication
3. Mathematical Competency/Quantitative Reasoning
4. Technological Literacy

Area B: PERSONAL GROWTH AND DEVELOPMENT

5. Self Assessment and Growth
6. Intellectual Engagement and Physical Wellness
7. Ethical Reasoning
8. Aesthetic Awareness and Appreciation

Area C: INTERPERSONAL/ INTERCULTURAL/ GLOBAL AWARENESS

9. Interpersonal Interaction and Community Participation
10. Intercultural Knowledge and Exploration
11. Discovering Global Issues

GENERAL GRADUATION REQUIREMENTS

A "continuing student" is one who has completed a minimum of one course per calendar year. Students who interrupt their attendance become subject to any new requirements which are in effect at the time they re-enroll.

- I. Unit Requirement. 60 to 64 units of course credit in a selected curriculum. One credit hour of community college work is approximately three hours of recitation, study, or laboratory work per week throughout a term of 16 weeks.
- II. Scholarship Requirement. A "C" (2.0) grade average or better in all work attempted.
- III. Competency Requirement. Students must demonstrate competence in reading, in written expression, and in mathematics. The following courses and examinations are approved to meet the competency requirement for the Associate Degree as defined in Board Rule 6201.12.
 - A. Reading and Written Comprehension:
 1. Competence in Reading and Written Expression shall be demonstrated by achieving a grade of "C" or better in English 101 or its equivalent at another college.
 2. In meeting the Reading and Written Expression competency requirement, course work is the primary measure of competency. However, competency may be met through credit-by-examination as determined in the college.
 - B. The competency requirement in mathematics may be met by:
 1. Competency in Mathematics shall be demonstrated by achieving in Math 125 or Math 124A and 124B or higher or its equivalent at another college.
 2. The competency requirement in Mathematics may also be met by completing an assessment and achieving a score determined to be comparable to satisfactory completion of Math 125 - Intermediate Algebra. That is, students may place into mathematics courses above the level of intermediate algebra or may achieve a satisfactory score on a competency exam or other approved exam.

- IV. Residence Requirement. Completion of at least 12 units or work in residence and attendance at the college during the semester in which the graduation requirements are completed. Exceptions may be made under special circumstances.
- V. Course Requirements. Students who are majoring in programs of study for which 18-35 units are required in the major and/or are planning to transfer should complete Graduation Requirements "Plan A." Students who are majoring in programs of study for which 36 or more units are required in the major and may not plan to transfer should complete Graduation Requirements "Plan B." Students who are following Graduation Requirements "Plan B" and plan to transfer should select the eighteen units for graduation requirements from Graduation Requirements "Plan A" to ensure all the courses for the Graduation Requirements transfer.

TRANSFER VS. CAREER EDUCATION PROGRAMS

Los Angeles City College offers over 115 degree and certificate programs in areas including the Arts, Business, Child Development, Cinema/Television, Cultural Studies, Computer Science, English, Foreign Languages, Health Care, Journalism, Law, Liberal Arts, Math, Psychology, Office Assistance and more. Associate degree programs designated as "Transfer Program" are designed for students planning to transfer to four-year universities and colleges as juniors. Students are urged to consult with one of our counselors to plan their academic programs and ensure successful transfer.

Associate degree programs designated "Career Program" are designed to prepare the student to enter occupational and technical fields upon graduation. Students interested in Career Programs who also plan to attend a four-year university, immediately after graduation or at a later point, should consult with one of our counselors on what other courses may be required to successfully transfer. Our Career Education programs also include certificate programs which require fewer general education courses.

PLAN A - TRANSFER PLAN

Graduation Requirements

Graduation "Plan A" has been designed for students who plan to transfer to either the California State University (CSU) system or the University of California (UC) system. The courses have been selected to parallel the CSU General Education plan. A transfer correlation outline that compares "Plan A," the CSU General Education plan, and the Intersegmental General Education Transfer Curriculum (IGETC) can be found at the end of this section. Verify the course description area of this catalog for transferability of courses found in these sections.

MAJOR REQUIREMENTS:

A minimum of eighteen (18) semester units of study taken in a single discipline or related disciplines.

GENERAL REQUIREMENTS:

Successful completion of a minimum of thirty to thirty-one (30-31) semester units of General Education which shall include not less than the minimum number of units indicated in each of the following areas:

A. Natural Sciences —

Minimum three (3) semester units.

Anatomy 1; **Anthropology** 101, 111; **Astronomy** 1, 5, 10, 11; **Biology** 1, 3, 6, 7, 25; **Chemistry** 51, 60, 68, 101, 102, 211, 212, 221; **Earth Science** 1; **Electronics** 101; **Environmental Science** 1; **Family and Consumer Studies** 21; **Geography** 1, 3, 15; **Geology** 1, 6; **Meteorology** 3; **Microbiology** 1, 20; **Oceanography** 1; **Physical Science** 1, 13, 14; **Physics** 1, 6, 7, 11, 12, 14, 21, 22, 101, 102, 103; **Psychology** 1; **Psychology** 2

Note: Laboratories are underlined

B. Social and Behavioral Sciences —

Minimum of nine (9) semester units

B1. AMERICAN INSTITUTIONS

(3 Semester Units minimum)

African-American Studies 4, 5, 7; **Chicano Studies** 7, 8; **History** 11, 12, 13, 81, 82; **Political Science** 1

B2. SOCIAL AND BEHAVIORAL SCIENCES

(3 Semester Units minimum)

African-American Studies 2; **Anthropology** 102, 103; **Asian-American Studies** 1; **Business** 1; **Child Development** 1, 11, 42; **Economics** 1, 2; **Family & Consumer Studies** 31; **Geography** 2; **History** 1, 2, 3, 4, 5, 6, 8, 59, 86, 87; **Journalism** 105; **Law** 3; **Linguistics** 2, 3; **Political Science** 2, 7; **Psychology** 1, 13, 18, 41, 43; **Sociology** 1, 2, 11, 12; **Speech** 122

B3. Minimum of 3 additional semester units from B1 or B2 above.

C. Humanities —

Minimum three (3) semester units.

African-American Studies 20, 21, 60; **American Sign Language** 1, 2, 3, 40; **Arabic** 1, 2, 3; **Armenian** 1, 2; **Architecture** 130, 131; **Art** 101, 102, 103, 105, 107, 109, 111, 201, 209, 501; **Asian-American Studies** 6; **Chicano Studies** 44, 52; **Chinese** 1, 2, 3, 4, 10, 21, 22; **Cinema** 3, 4; **Dance** 805; **French** 1, 2, 3, 4, 10, 21, 22; **English** 203, 204, 205, 206, 208, 211, 212, 214, 215, 216, 218, 219, 221, 239, 240, 252, 253, 255, 270; **Humanities** 6, 8, 20, 30, 31, 41, 42, 44, 45, 47, 48, 61, 63; **Italian** 1, 2, 3, 4, 10, 21, 22; **Japanese** 1, 2, 3, 4, 21, 22; **Korean** 1, 2, 3, 4, 10, 21, 22; **Linguistics** 1; **Music** 101, 111, 121, 122, 133, 135, 200; **Philosophy** 1, 2, 12, 14, 19, 20, 30, 32, 35, 40, 41; **Photography** 10, 17, 34; **Russian** 1, 2, 3, 4, 10, 12, 21, 22; **Spanish** 1, 2, 3, 4, 9, 10, 11, 15, 21, 22, 35, 36; **Speech** 130; **Theater** 100, 110, 400

D. Language and Rationality —

Minimum twelve (12) semester units in the following pattern:

D1. ENGLISH COMPOSITION

(3 Semester Units minimum)

English 28, 31, 101; **Journalism** 101

D2. COMMUNICATION AND ANALYTICAL THINKING

(6 Semester Units minimum)

Co Sci 101, 103, 108; **Co Tech** 1; **English** 102, 103; **Mathematics** 124A, 124B, 125, 215, 216, 225, 227, 230, 235, 236, 237, 240, 245, 260, 261, 262, 263, 270, 272, 275; **Philosophy** 5, 6, 7, 8, 9; **Psychology** 66; **Speech** 101, 102, 104, 121

D3. Minimum of 3 additional semester units from **D1** or **D2** above.

E. Health and Physical Education —

Minimum three (3) units.

E1. HEALTH EDUCATION

(2 Semester Units minimum)

Health 2, 8, 10, 11

Note: Health 2 includes the physical education activity

E2. ONE PHYSICAL EDUCATION ACTIVITY

(1 Semester Unit minimum)

Dance Spec 440, 446, 459; **Dance St** 452; **Dance Tech** 400-469; **Phys Ed** 101-649

Authorized Physical Education activity exemptions include:

- Medical exemption
- Extenuating Circumstances
- Licensed Registered Nurse
- Students who have served in the Armed Forces of the United States (DD 214)

PLAN B -- OCCUPATIONAL/ VOCATIONAL PLAN GRADUATION REQUIREMENTS

Graduation “Plan B” has been designed for students who plan an occupational or vocational Associate degree. Some courses may or may not transfer to the University of California or the California State University system. Verify the course description area of this catalog for transferability of courses found in these sections.



MAJOR REQUIREMENTS:

At least a minimum of thirty-six (36) semester units of study taken in a single major or related disciplines.

GENERAL REQUIREMENTS:

Successful completion of a minimum of eighteen (18) semester units in General Education which shall include not less than the minimum number of units indicated in each of the following areas:

A. Natural Sciences —

Minimum 3 units

Anatomy 1; **Anthropology** 101, 111; **Astronomy** 1, 5, 10,11; **Biology** 1, 3, 6, 7, 25; **Chemistry** 51, 60, 68, 101, 102, 211, 212, 221; **Earth Science** 1; Electronics 101; **Environmental Science** 1; **Family and Consumer Studies** 21; **Geography** 1, 3, 15; **Geology** 1, 6; **Meteorology** 3; Microbiology 1, 20; **Oceanography** 1; **Physical Science** 1, 13, 14; **Physics** 1, 6, 7, 11, 12, 14, 21, 22, 101, 102, 103; **Physiology** 1; **Psychology** 2

Note: Laboratories are underlined

B. Social and Behavioral Sciences —**B1. AMERICAN INSTITUTIONS**

3 Semester Units minimum)

African-American Studies 4, 5, 7; **Chicano Studies** 7, 8; **History** 11, 12, 13, 81, 82; **Political Science** 1

C. Humanities —

Minimum 3 units

African-American Studies 20, 21, 60; **American Sign Language** 1, 2, 3, 40; Arabic 1,2, 3; **Armenian** 1, 2; **Architecture** 130, 131; Art 101, 102, 103, 105, 107, 109, 111, 201, 209, 501; **Asian-American Studies** 6; **Chicano Studies** 44, 52; **Chinese** 1, 2, 3, 4, 10, 21, 22; **Cinema** 3, 4; **Dance** 805; **French** 1, 2, 3, 4, 10, 21, 22; **English** 203, 204, 205, 206, 208, 211, 212, 214, 215, 216, 218, 219, 221, 239, 240, 252, 253, 255, 270; **Humanities** 6, 8, 20, 30, 31, 41, 42, 44, 45, 47, 48, 61, 63; **Italian** 1, 2, 3, 4, 10, 21, 22; **Japanese** 1, 2, 3, 4, 21, 22; **Korean** 1, 2, 3, 4, 10, 21, 22; **Linguistics** 1; **Music** 101, 111, 121, 122, 133, 135, 200; **Philosophy** 1, 2, 12, 14, 19, 20, 30, 32, 35, 40, 41; **Photography** 10, 17, 34; **Russian** 1, 2, 3, 4, 10, 12, 21, 22; Spanish 1, 2, 3, 4, 9, 10, 11, 15, 21, 22, 35, 36; **Speech** 130; **Theater** 100, 110, 400

D. Language and Rationality —

Minimum six (6) semester units in the following pattern

(Select one course from each area.)

D1. ENGLISH COMPOSITION

(3 Semester Units minimum)

English 28, 31, 101; Journalism 101

D2. COMMUNICATION AND ANALYTICAL THINKING

(3 Semester Units minimum)

Co Sci 101, 103, 108; **Co Tech** 1; **English** 102, 103; **Mathematics** 124A, 124B, 125, 215, 216, 225, 227, 230, 235, 236, 237, 240, 245, 260, 261, 262, 263, 270, 272, 275; **Philosophy** 5, 6, 7, 8, 9; **Psychology** 66; **Speech** 101, 102, 104, 121

E. Health and Physical Education —

Minimum three (3) semester units.

E1. HEALTH EDUCATION

(2 Semester Units minimum)

Health 2 , 8, 10, 11

Note: Health 2 includes the physical education activity

E2. ONE PHYSICAL EDUCATION ACTIVITY

(1 Semester Unit minimum)

Dance Spec 440, 446, 459; **Dance St** 452; **Dance Tech** 400-469; **Phys Ed** 101-649

Authorized Physical Education activity exemptions include:

- Medical exemption
- Extenuating Circumstances
- Licensed Registered Nurse
- Students who have served in the Armed Forces of the United States (DD 214)

NOTE: Graduation Requirements

Plans "A" & "B"

While a course might satisfy more than one General Education requirement, it may not be counted more than once for these purposes. It may be counted again for a different degree requirement as determined by each college. Refer to the chart following this page for information about the correlation between "Plans A" and "B."

A course may meet a General Education requirement for the Associate degree and also partially satisfy a General Education requirement at the California State University. Students may not use the same course for credit toward the Major and the General Education requirements for the Associate degree.

* Denotes lab.

** Requirement for American Institution and Government.

Classified in another area of the CSU-GE Certification.

+ Not acceptable for transfer, or transfers as an Elective only.

GRADUATION PETITIONS FOR DEGREE

Students who are eligible for graduation from Los Angeles City College must file a Graduation Petition in the semester preceding when they anticipate graduating.

- JUNE GRADUATES: Students petitioning for June graduation should file during the first eight weeks of the Fall semester.
- JANUARY GRADUATES: Students petitioning for January graduation should file during the first eight weeks of the Spring semester

CERTIFICATE OF COMPLETION

Career and Occupational Certificates are issued to students who have completed a selected sequence of courses leading toward an occupational objective. The sequence is designed to prepare a student for a position of employment indicated by the specific certificate. The total number of units required for a certificate varies with different curricula. Most courses taken for Certificates in Career and Occupational Education apply toward an Associate degree.

Students must attain a minimum of a "C" (2.0) grade point average in all required courses. The student cannot be awarded a certificate without making up any deficiencies such as "F" grades, Incompletes, or Withdrawals.

To obtain the Certificate, the student should:

1. Determine which courses are required for the Certificate by reviewing the department requirements (listed elsewhere in this catalog).
2. Obtain a copy of his or her transcript to verify completion of required courses.
3. Present the transcript to the Department Chairperson (or program coordinator) with the request that it be evaluated for awarding of the Certificate.

Department representatives will evaluate the transcript, and the student will be notified whether the requirements have been met. Each department will award its own certificates.

Graduation With Honors

Students who qualify may graduate with honors from Los Angeles City College. There are three categories under which such students may graduate.

Summa Cum Laude is granted to students who have maintained a 3.9+ grade point average in all work taken at Los Angeles City College.

Magna Cum Laude is granted to students who have maintained a 3.7+ grade point average in all work taken at Los Angeles City College.

Cum Laude is granted to students who have maintained a 3.5+ grade point average in all work taken at Los Angeles City College.

For Dean's List/Honor Roll information, see "Policies: Academic"

GENERAL INFORMATION FOR TRANSFER

The information below has been compiled to help Los Angeles City College students who intend to transfer to a four-year college or university.

Students who plan to earn a Bachelor degree should take a pattern of courses designed to complete the lower division preparation for their major and the general education. There are several options for completing General Education requirements.

Los Angeles City College can provide the lower division preparation for most majors at many of the California four-year public colleges and universities and select private universities.

For purposes of classification, students who are paralleling the work of four-year colleges and universities are indicated as transfer students.

Three principal kinds of requirements must be met in order to attain full junior standing at California public universities or other institutions of higher education maintaining equivalent standards. They are as follows:

1. Completion of the specific General Education requirements for junior standing. For the University of California (UC), students should complete the Intersegmental General Education Transfer Curriculum (IGETC) requirements. For California State University (CSU), students should complete the CSU General Education certification pattern. Students who are undecided regarding choice of transfer institution should complete the IGETC.
2. Completion of a minimum of 60 units to a maximum of 70 transferable semester units will permit a student to enter the university at the junior level.

3. Completion of the lower division major and minor course preparation. These vary according to the institution where students are seeking admissions.
4. Students transferring to private colleges or universities in California or other states must see a College Counselor or University Transfer Center staff for transfer requirements.

TRANSFER OF CAREER EDUCATION CLASSES

All Los Angeles City College transfer and occupational education courses are college level courses and may be applied toward graduation requirements for the Associate in Arts or Associate in Science degree. Following each course title in the Course Description section is a set of letters indicating the credit toward the Associate Degree or credit toward transfer to one of the California State University or the University of California campuses.

COURSE CREDIT VALUE

The following abbreviations are used in course descriptions:

- UC indicates the course is acceptable for unit credit at all campuses of the University of California.
- CSU indicates the course is Baccalaureate transferable for unit credit at all campuses of the California State University.
- A (Associate Degree level) indicates the course is acceptable toward fulfillment of the Associate in Arts or Associate in Science degree.
- NDC (Non-degree Course) indicates a course that presents prerequisite or preparatory work for the Associate level courses. Credit is given toward computing the grade point average but may not be used toward graduation requirements.
- NC (Non-credit Course) indicates the course is remedial and developmental to help students prepare for further advanced courses.

"Students are not likely to succeed in courses classified as UC or CSU transferable if they are not eligible to enroll in English 28 or higher." This statement identifies the indicated level of potential success a student may expect regarding a specified course.

Students intending to transfer to a college or university upon the completion of their studies at Los Angeles City College should consult the requirements of the institution of their choice and develop a "Student Educational Plan" with an LACC counselor.

THE UNIVERSITY OF CALIFORNIA (UC) SYSTEM

The University of California (UC) system has eleven campuses throughout the state. This catalog gives information concerning requirements for the Intersegmental General Education Transfer Curriculum (IGETC), which transfers to ten campuses.

For specific information regarding preparation for the colleges at the University of California at Los Angeles (UCLA) (Letters and Science, School of the Arts, and School of Theatre, Film and Television, and School of Engineering) please see a counselor.

Information regarding preparation in the majors for most of the UC campuses is available from the Los Angeles City College Counseling or University Transfer Centers. Major requirements have been articulated on a course-for-course basis to enable students to complete most of their lower division preparation at LACC.

TRANSFER REQUIREMENTS

(Advanced Standing Admission)

An "advanced standing" student is one who has been a registered student in another college or university or in college-level extension classes other than a summer session immediately following high school graduation.

Advanced standing applicants may not disregard their college records and apply for admission as a freshman.

Students planning to transfer to a UC campus should discuss their transfer plans with College Counselor every semester they attend LACC, in as much as significant changes frequently occur in requirements, subsequent to the printing of this catalog, and during the life of this catalog.

ADVANCED STANDING ADMISSION Requirements

Requirements for admission in advanced standing vary according to your high school record. LACC students planning to transfer to any UC campus are required to have an official copy of their high school transcript sent to the Admissions Office. UC requires an exact pattern of high school subjects.

If deficiencies in either subjects or grades exist, they can be made up with courses taken at LACC. A student who has not graduated from high school or who has not graduated but has passed the State Proficiency Exam or has a General Education Diploma (G.E.D.) may also make up subject and grade deficiencies at LACC. In many cases, these courses also will help satisfy the college breadth requirements. Students are expected to complete:

1. Basic Proficiency Level courses.
2. General Education requirements.
3. Major subject requirements.

Courses described in this catalog with UC in parentheses are transferable to the UC system. If you have attended and received credit from any four-year college or university, please consult with a College Counselor regarding admissibility to the UC.

THE CALIFORNIA STATE UNIVERSITY (CSU) SYSTEM ADMISSION

Students intending to transfer to a California State University campus should plan a program to meet the graduation requirements of the specific institution which they plan to attend. Transfer admission eligibility is based on transferable college units or high school record and test score. Consult the catalog issued by the individual campus for a complete description of the curricula or with an LACC counselor.

Applicants who are California residents and who have completed 60 to 70 transferable semester units (90-105 quarter units) are eligible for admission if they:

A. Are in good standing at Los Angeles City College, **and**

B. Have achieved a 2.0 or better grade point average in all college units attempted (nonresidents, 2.4 or better)

Students entering must complete 9 units in English language course work and the mathematics requirement and additional

units within the General Education certification pattern to equal 30 units of General Education. Students in pre-majors with a total of 40 or more units should consult with an LACC counselor regarding completion of the General Education subject requirement for admission to the California State University system.

Students with fewer than 56 transferable semester units (84 quarter units) completed are eligible for admission if they:

- A. Are in good standing at Los Angeles City College **and**
- B. Have achieved a 2.0 or better grade point average in all college units attempted, and were either
 1. Eligible for admission as first-time freshmen or
 2. Eligible for admission as first-time freshmen except for completion of the subject requirements and have removed deficiencies in those required college preparatory subjects with acceptable college work.

Consult with a counselor regarding ways to fulfill the subject requirement deficiency.

Admission to a California State University campus does not guarantee admission to the major department or college on that campus.

REQUIREMENTS FOR THE BACHELOR'S DEGREE

The degree requirements at a California State University campus consist, in general, of three parts: first, the General Education Requirements, which are required of all degree candidates; second, the Major Department Requirements, which are a part of the student field of specialization; and third electives. Students with high-unit majors should take electives after transfer.

These requirements are classified in two levels: Lower Division and Upper Division. Students may complete most of the lower division requirements in the major and all of the lower division in the general education pattern at Los Angeles City College.

TRANSFER INFORMATION

University of California (UC) & California State University (CSU) General Education Articulation Agreements

The California State University (CSU) delegates authority to Los Angeles City College to identify courses applicable towards the CSU curriculum:

1. Courses that transfer for Baccalaureate credit;
2. Courses that fulfill CSU lower division General Education-Breadth requirements;
3. Courses that fulfill the United States history, constitution and American ideals requirements.

Up to 39 or the 48 General Education-Breadth units required for the Baccalaureate degree can be transferred from Los Angeles City College. Students who are certified with 39 semester units of lower division General Education-Breadth units will be required to complete a minimum of 9 semester units of upper division General Education work after transfer. Students completing this pattern must complete the nine (9) units in Area A with a "C" grade or better in each course and a "C" grade or better in mathematics, Area B3. Students must also complete 30 units taken from Area B through Area E.

The California State University assigns a high priority to Los Angeles City College transfer students who have completed the first two years of their Baccalaureate program (60-70 units). Los Angeles City College students transferring with 60 units minimum enter at junior level standing and may enter their major upper division work if all prerequisites have been completed. Executive Order 595, General Education Requirements, Office of the Chancellor, California State University, establishes that all students must fulfill the requirements. Previous General Education requirements will not carry catalog rights after January 1994. IGETC units will be certified by the graduation clerks when verified by LACC Counselors. Pass Along will be honored from other community colleges for courses approved for the IGETC.

An alternative to the lower division requirements stated above is the Intersegmental General Education Transfer Curriculum (IGETC). IGETC requires completion of a minimum of 37 semester units of lower division work with a “C” grade or better in each course completed. Students must complete all areas to become certified.

You must complete the IGETC before transferring. This is an all or none situation. (Completion and certification of the IGETC may not fulfill the Admissions Requirements for the UC or CSU.)

Completion of the IGETC will permit a student to transfer from Los Angeles City College to a campus in either the California State University or University of California system without the need, after transfer, to take additional lower-division General Education courses to satisfy the university General Education requirements.

Completion of the IGETC is not a requirement for transfer to CSU or UC, nor is it the only way to fulfill the lower-division General Education requirements of the CSU or UC prior to transfer. Depending on a student major and field of interest, the student may find it better to take courses fulfilling the CSU General Education requirements or those of the UC campus to which the student plans to transfer. Students pursuing majors that require extensive lower-division preparation (such as Engineering or Biology) may not find the IGETC option to be advantageous.

INTERSEGMENTAL GENERAL EDUCATION TRANSFER CURRICULUM (IGETC) POLICY

Completion of all of the requirements in the Intersegmental General Education Transfer Curriculum will permit a student to transfer from Los Angeles City College to a campus in either the California State University or University of California system without the need, after transfer, to take additional lower-division, General Education courses to satisfy campus General Education requirements.

The course requirements for all areas must be completed before the IGETC can be certified. All courses must be completed with grades of “C” or better.

IGETC units will be certified by the graduation clerks when verified by LACC Counselors. Pass Along will be honored from other community colleges for courses approved for the IGETC.

You must complete the IGETC before transferring. (Completion and certification of the IGETC may not fulfill the Admissions Requirements for the UC or CSU.)

AREA 1: ENGLISH COMMUNICATION CSU:

three courses required, one from each group below. UC:
two courses required, one each from group A and B.

- Group A: English Composition
Select 1 course, 3 semester units (minimum): English 101, +101H.
- Group B: Critical Thinking English Composition Select 1 course, 3 semester units (minimum): English 102, 102 H, 103, Philosophy 5
- Group C: Oral Communication 3 semester units (CSU ONLY); Speech Communication 101, 102, and 121 (Students transferring to the UC do not have to meet this requirement.)

AREA 2: MATHEMATICAL CONCEPTS AND QUANTITATIVE REASONING

Select 1 course, 3 semester units (minimum): **Mathematics** +225, +227, 230, +235, +236, +237, +245, +260, +261, +261H, +262, +262H, +263, 270, 272, 275. “+” UC transfer credit limit.

AREA 3: ARTS AND HUMANITIES

At least 3 courses, with one from the Arts and one from the Humanities and one from either Arts or Humanities, nine semester units (minimum).

3A: ARTS

African-American Studies 60 (same as Music 135); **Art** 101, 101H, 102, 102H, 103, 105, 107 (same as **Chicano Studies** 52), 109; **Cinema** 3, 4; **Dance** 805; **Music** 111, 111H, 121, 122, 133, 135 (same as **African-American** 60), **Photography** 34; **Theater** 400.

3B: HUMANITIES

African-American Studies 3, 20, 21; **American Sign Language** 40; **Chicano Studies** 44; **English** 203, 204, 205, 206, 208, 211, 212, 214, 215, 216, 219, 221, 239, 240, 252, 253, 255, 270; **Foreign Languages** course 3, 4 in **American Sign Language**, **Arabic**, **Chinese**, **French**, **German**, **Italian**, **Japanese**, **Korean**, **Russian**, **Spanish**; **Course 10** in **Chinese**, **French**, **Italian**, **Korean**, **Russian**, **Spanish**; **Course 11** in **Italian**, **Spanish** 5, 6; **History** 86, 87; **Humanities** +6, +8, 20, 30, 31, 41 (same as **Chinese** 10), 42 (same as **French** 10), 44 (same as **Italian** 10), 45 (same as **Korean** 10), 47 (same as **Spanish** 9), 48 (same as **Spanish** 10), 60, 61, 63, 73; **Linguistics** 1; **Philosophy** 1, 1H, 2, 12, 14, 19, 20, 30, 32, 35, 40, 41; **Russian**, 12; **Spanish** 9; **Theatre Arts** 100, 110.

AREA 4: SOCIAL & BEHAVIORAL SCIENCES

At least three courses from two disciplines or an interdisciplinary sequence: 9 semester units (min)

African-American Studies 2, +4, 5, 10(*); +7; **Anthropology** 102, 103; **Asian-American Studies** 1, 10(*); **Chicano-Studies** 7, +8; **Child Development** 1; **Economics** 1; **Geography** 2, 2H, 7; **History** 1, 2, 3, 4, 5, 6, 8, +11, +12+, 12H, +13, 86, 87; **Law** 3; **Linguistics** 2; **Political Science** +1, +1H; **Psychology** 1, 1H, 8(*), 13, 18, 31(*); **Sociology** 1, 2, 11, 12; **Speech** 121, 122.

Courses designated with a +, if used to fulfill the United States History, Constitution and American Ideals requirement for the CSU, may not be doubled counted for the Social and Behavioral Sciences requirement.

AREA 5: PHYSICAL & BIOLOGICAL SCIENCES

Two courses, one Physical Science course and one Biological Science course; at least one must include a laboratory 7-9 sem. units (minimum)

5A: PHYSICAL SCIENCES

Astronomy 1, 5, 10, 11; **Chemistry** 51, 60, 68, 101, 221; **Earth Science** 1; **Geography** 1, 3(*), 15; **Geology** 1, 6; **Meteorology** 3(*); **Oceanography** 1; **Physical Science** 1, 14; **Physics** 1, 6, 11, 12, 14, 21, 101, 102, 103.

5B: BIOLOGICAL SCIENCES

Anatomy 1; **Anthropology** 101, 101H; **Biology** 1, 3, 3H, 6, 7, 25; **Microbiology** 1, 20; **Oceanography** 12; **Physiology** 1; **Psychology** 2.

NOTE: Courses underlined indicate those with a laboratory component.

(UC REQUIREMENT ONLY)

LANGUAGE OTHER THAN ENGLISH

Proficiency equivalent to two years of high school study in the same language. (May use any Foreign Language course listed in the Los Angeles City College catalog through level two [example: French 1+2].)

(CSU ONLY)

Bachelor's Degree Graduation Requirement In United States History, Constitution And American Ideals (Requirements listed here are not part of IGETC. The following courses may be completed prior to transfer.)

Six units, one course from group 1 and one course from group 2.

1. **African-American** 7+, **Political Science** +1, +1H
2. **History** +11, +12, +12H, +13; **African-American Studies** +4, +5; **Chicano Studies** +8.

NOTES: (*) Courses may be listed in more than one area, but shall not be certified in more than one area; + indicates that transfer credit may be limited either by UC or CSU or both. Please consult with a College Counselor.

CSU GENERAL EDUCATION CERTIFICATION

Listed below are the requirements for California State University (CSU) General Education certification policy for students transferring to one of the 23 CSU campuses and petitioning for full or partial certification from Los Angeles City College. (Please read carefully.)

1. Students transferring from Los Angeles City College must submit a petition for full or partial certification to the LACC graduation office.
2. Students fully or Area D certified by Los Angeles City College or by Pass Along status, may double count the requirements for United States History, Constitution, and American Ideals.
3. Students must complete all requirements stipulated in Areas A, B, C, D, E for full certification.
4. Students may receive partial certification by fulfilling requirements stipulated in each Area. ONLY the area will be certified, not individual courses.
5. Students should submit a Certification Petition for certification when requesting their transcript or when requesting the graduation check for the Associate degree.
6. Students with high unit majors (i.e., Biological Sciences, Engineering) may be granted exceptions to the full certification requirements by the CSU campus. Students seeking transfer under this provision shall be responsible

for requesting verification from the transferring institution.

7. **Pass Along Policy:** Courses taken at other institutions (including California Community Colleges outside the Los Angeles Community College District) that have been approved for certification by the California State University system may be given Pass Along status. Please consult with a College Counselor regarding approved courses to receive Pass Along.

General Education Certification for The

California State University - Executive Order 595

A. English Language Communication and Critical Thinking (9 Units)

Select one course from each section.

A1. Oral Communication: **Speech** 101, 102, 121

A2. Written Communication: **English** 101, 101H

A3. Critical Thinking: **English** 102, 102H, 103; **Philosophy** 5, 6, 7, 8, 9; **Psychology** 66; **Speech Communication** 104

B. Scientific Inquiry and Quantitative Reasoning

(9 Units) Select one course from Physical Science, and one course from Life Science with a least one laboratory course from either, and one course from Mathematics/Quantitative Reasoning.

"+" Meets laboratory requirement.

B1. Physical Science:

Astronomy 1, 10, or 11 with 5+; **Chemistry** 101+, 51+, 60+, 68+, 221+; **Earth Science** 1; **Electronics** 101; **Environmental Science** 8; **Geography** 1 with 15+, 3; **Geology** 1, 1H with 6+, 11; **Meteorology** 3; **Mineralogy** 1+; **Oceanography** 1; **Physical Science** 1 with 14+; **Physics** 1+, 6+, 11+, 12 with 14+, 21+, 101+, 102+, 103+

B2. Life Science:

Anatomy 1+; **Anthropology** 101 or 101H with 111+, **Biology** 1, 3+, 3H+, 6+, 7+, 23, 25; **Microbiology** 1+, 20+; **Oceanography** 12; **Physiology** 1+; **Psychology** 2

B3. Laboratory Activity:

one of the courses from B1 or B2 must be a lab course designated by +.

B4. Mathematical/Quantitative Reasoning:

Mathematics 215, 225, 227, 230, 230H, 235, 236, 237, 240, 245, 260, 261, 261H, 262, 262H, 263, 270, 272, 275.

C. Arts and Humanities (9 units)

Select one course from, The Arts and one course from, The Humanities and one course from either section.

1. The Arts:

African-American Studies 60*; **Architecture** 130, 131; **Art** 101, 101H, 102, 102H, 103, 105, 107*, 109, 111, 201, 209, 501; **Chicano Studies** 52*; **Cinema** 3, 4; **Dance** 805; **English** 253; **Music** 101, 111, 111H, 121, 122, 133, 135*, 200; **Photography** 10, 17, 34; **Theatre** 100, 110, 400.

2. The Humanities:

African-Am. St. 20, 21; **ASL** 1, 2, 3, 40; **Arabic** 1, 2, 3; **Armenian** 1, 2; **Chicano St.** 44; **Chinese** 1, 2, 3, 4, 10*; **English** 203, 204, 205, 206, 208, 211, 212, 214, 215, 216, 218, 219, 221, 239, 240, 252, 253, 255, 270; **French** 1, 2, 3, 4, 10*, 21, 22; **History** 3, 4, 86, 87; **Humanities** 6, 8, 20, 21, 30, 31, 41*, 42* 44*,

45*, 47*, 48*, 61, 63, 70; **Italian** 1, 2, 3, 4, 10*, 11, 21, 22; **Japanese** 1, 2, 3, 4; **Korean** 1, 2, 3, 4, 10*, 21, 22; **Latin** 1, 2; **Linguistics** 1; **Philosophy** 1, 2, 12, 14, 19, 20, 30, 32, 35, 40, 41; **Russian** 1, 2, 3, 4, 10, 12; **Spanish** 1, 2, 3, 4, 5, 6, 9*, 10*, 11, 15, 21, 22, 35, 36; **Speech** 130.

***Cross reference:** Credit given to only one of Art 107 and Chicano Studies 52; African-American Studies 60 and Music 135. English 102 prior to Fall 1999 Area C2.

* Students transferring to CSU are required to take Speech Communication 101.

** Students transferring to CSU using the IGETC may not use American History and Government for General Education requirement.

*** Students transferring to UC must fulfill this requirement.

+ Part of the 12-unit minimum - Area “A”

++ May be counted in General Education Area “D”

D. Social Sciences

(9 Units Minimum)

U.S. History, Constitution, and American Ideals requirement: Select one course from A and one course from B.

D-A: African-American Studies 4, 5; **Chicano Studies** 8; **History** 11, 12, 12H, 13.

D-B: African-American Studies 7; **Political Science** 1, 1H Select one additional course not taken from D-A or D-B above, from D1 through D10.

D1. Anthropology: Anthropology 102, 103.

D2. Economics: CSIT 103; **Economics** 1, 2; **Journalism** 105.

D3. Ethnic Studies: African-American Studies 2, 3, 6, 10*, **Sociology** 11.

D4. Gender Studies: No Courses.

D5. Geography: Geography 2, 2H.

D6. History: African-American Studies 4, 5;

Chicano

Studies 7, 8; **History** 1, 2, 3, 4, 5, 6, 11, 12, 12H, 13, 86, 87.

D7. Interdisciplinary: Linguistics 2; **Psychology** 8*, 31*.

D8. Political Science: Government, Legal Asian-American Studies 1, 10*; **Chicano Studies** 19; **Business** 1; **Law** 3; **African American Studies** 7; **Political Science** 1, 1H, 2, 7.

D9. Psychology: Child Dev. 1; **Linguistics** 3; **Psychology** 1, 1H, 13, 18+++.

D10. Sociology & Criminology: **Sociology** 1, 2; **Speech** 121, 122

*Cross reference: Credit given to only one of African-American Studies 10 and Psychology 8; Asian-American Studies 10 and Psychology 1.

E. Life Long Understanding And Self Developments

(3 Units) **Child Development** 1; **Environmental Science** 1; **Family & Consumer Studies** 21, 31 (same as **Sociology** 12); **Personal Development** 20, 40; **Health** 2++, 8++, 11++, 21; **Humanities** 60; **Psychology** 18+++; 41, 43, 60; **Dance** 400, 405, 406, 408, 410, 431, 434, 437, 440, 446, 452, 466, 467, 468, 469 (maximum of 1 unit total).

NOTES:

1. Credit given to one course.
2. United States History, Constitution, and American Ideals: Six (6) semester units are required. Courses in Area D-A and D-B above may be used as double counting for both fulfillment in Area D and the U.S. History, Constitution and American Ideals requirement as long as the student meets full or Area D certification.
3. + Meets laboratory requirement.
4. ++ Health requirement for the Associate degree may be satisfied by taking Health 8, 11, or 10, and one unit of Physical Education or Health 2, a health/physical combined course.
5. +++ Course listed in more than one area shall be certified in one area only.
6. Courses used to satisfy requirements for lower division major core may also be used to satisfy General Education Requirements if the total area has been certified. (i.e. A 1, 2, 3)
7. Students must petition for certification before transferring.

CAL STATE UNIVERSITY LOS ANGELES (CSULA) MAJOR DEPARTMENT REQUIREMENTS

The specific major course requirements for CSULA can be located on the web at www.assist.org “Articulation by Major.”

INDEPENDENT CALIFORNIA COLLEGES AND UNIVERSITIES

California fully accredited independent colleges and universities provide a wide range of options at undergraduate, graduate and professional levels for students planning to continue their education beyond community college.

ADMISSION POLICIES

Students who transfer to independent colleges or universities find they are given academic credit for most, if not all, of their community college studies.

Virtually all institutions give full credit for General Education courses and usually other courses designated for transfer by the community college.

Articulation agreements for General Education requirements and some major requirements may be obtained from the LACC Counseling Center. The Center maintains information for BIOLA College; Claremont McKenna College; Cleveland Chiropractic College; Golden Gate University; Loyola University; Mount St. Mary's University; Pepperdine University; the University of Southern California; and others.

Some colleges and universities stipulate that a certain number of units must be completed before considering eligibility for transfer. The requirements are outlined in the respective college catalogs. Please consult with a College Counselor or the academic advisor from the college or university visiting the Transfer Center.

Independent institutions are generous in awarding credit. They invite students to make an appointment with their Office of Admissions in order to discuss transfer opportunities on a personal basis.

HONORS PROGRAM

**NOTE: Previously called Scholars Program
(323) 953-4000 ext. 2057**

[http://www.lacitycollege.edu/services/honorsprogram/
Page_1x.html](http://www.lacitycollege.edu/services/honorsprogram/Page_1x.html)

The Honors Program is designed to prepare the highly motivated student for transfer. The program's enriched and rigorous curriculum challenges those who thrive on intellectual exercise. Honors Program students may have the opportunity to do projects in service learning, tutoring and research.

The student who completes 18 units of Honors credit will receive certification in UCLA's Transfer Alliance Program (TAP).

This guarantees priority consideration for admission to non-impacted majors in UCLA's College of Letters and Sciences, and increases the student's chances of being admitted. Among other partners are Irvine, UC Riverside, UC Santa Cruz, Occidental College, Chapman University, and La Sierra University.

Honors' Program Benefits:

- Transfer scholarships
- Early registration for all LACC classes
- Counseling and transfer advisement
- Special Counseling and smaller Honors classes
- Library privileges at UCLA and various other UC schools
- Honors and research opportunities through the National and Western Regional Honors Council
- Get-togethers throughout the academic year

Program Requirements:

1. Maintain minimum 3.0 GPA (cumulative).
2. Complete 18 units in designated Honors sections.
4. Complete English 101 or 012 with a "C" or better.

Students may apply to the Honors Program at any time during the year. Be advised that Honors courses are only offered in Fall and Spring semesters. Students should plan their schedules accordingly.

University Transfer Center

Administration Bldg 109 • (323) 953-4000 ext. 2215

<http://www.lacitycollege.edu/services/transfer/index.html>

The college University Transfer Center brings access to higher education at a four-year university within reach for any student seeking the university experience. It is the intent of the Center to assist students to move on to the next level of higher education as they strive to reach academic, personal and professional goals. Students who have completed 24 transferable units including English 101, are automatically considered to have begun the transfer process. So, even students who have not identified transfer as a goal are encouraged to visit the Transfer Center.

The Center offers a variety of opportunities and services for students seeking to transfer including:

- University research library.
- Guarantee Admission Agreements with select universities.
- Guidance through the transfer process for California and nationwide universities.
- Applications to special summer programs for prospective transfer students such as UCLA's Summer Intensive Transfer Experience (SITE) CalSOAP Senior Summer Bridge Institute, UC Berkeley – Summer Cal. and others
- Transfer preparation and transfer ready workshops on campus and at universities.
- Representatives from the University of California, California State University and the Association of Independent California Colleges and Universities regularly are available for one-on-one consultations in the Center. NOTE: Students should review the general education and pre-major preparation courses with a counselor of the University Transfer Center before making an appointment with a university representative.



SUBJECT AREA	IGETC CURRIGULUM	CSU GENERAL EDUCATION	LACC "PLAN A" ASSOCCATE DEGREE
ENGLISH COMPOSITION	6-9 UNITS English 101, 102, 103 Philosophy 5; Speech Comm. 101*	9 UNITS MINIMUM English 101, Critical Thinking	12 UNITS MINIMUM English 101; Speech Comm. 101 Critical Thinking; +Mathematics
MATHEMATICS	3 UNITS MINIMUM	3 UNITS MINIMUM	3 UNITS MINIMUM +(Part of 12-units minimum)
ARTS HUMANITIES FOREIGN LANGUAGES LIT- ERATURE	9 UNITS MINIMUM At least one course in the Arts and one in the Humanities and one from either area.	9 UNITS MINIMUM At least one course in the Arts and one in the Humanities and one from either area.	3 UNITS MINIMUM One course from the Arts or the Humanities.
SOCIAL SCIENCE POLITI- CAL SCIENCE ECONOMICS BEHAVIORAL SCIENCE	9 UNITS MINIMUM In at least two disciplines within this area.**	9 UNITS MINIMUM At least one course from two subject areas. ++American History and Government	9 UNITS MINIMUM At least one course in American Institutions or Government. Two courses from Social and Behavioral Science and/or from Economic and political.
LIFELONG UNDERSTANDING HEALTH EDUCATION PHYSI- CAL EDUCATION	None	3 UNITS MINIMUM One course. LACC "PLAN A" ASSOCIATE DEGREE	2-3 UNITS MINIMUM Health course. Physical Education: 1-unit
FOREIGN LANGUAGE	Proficiency equivalent to two years of high school study.*** None		None

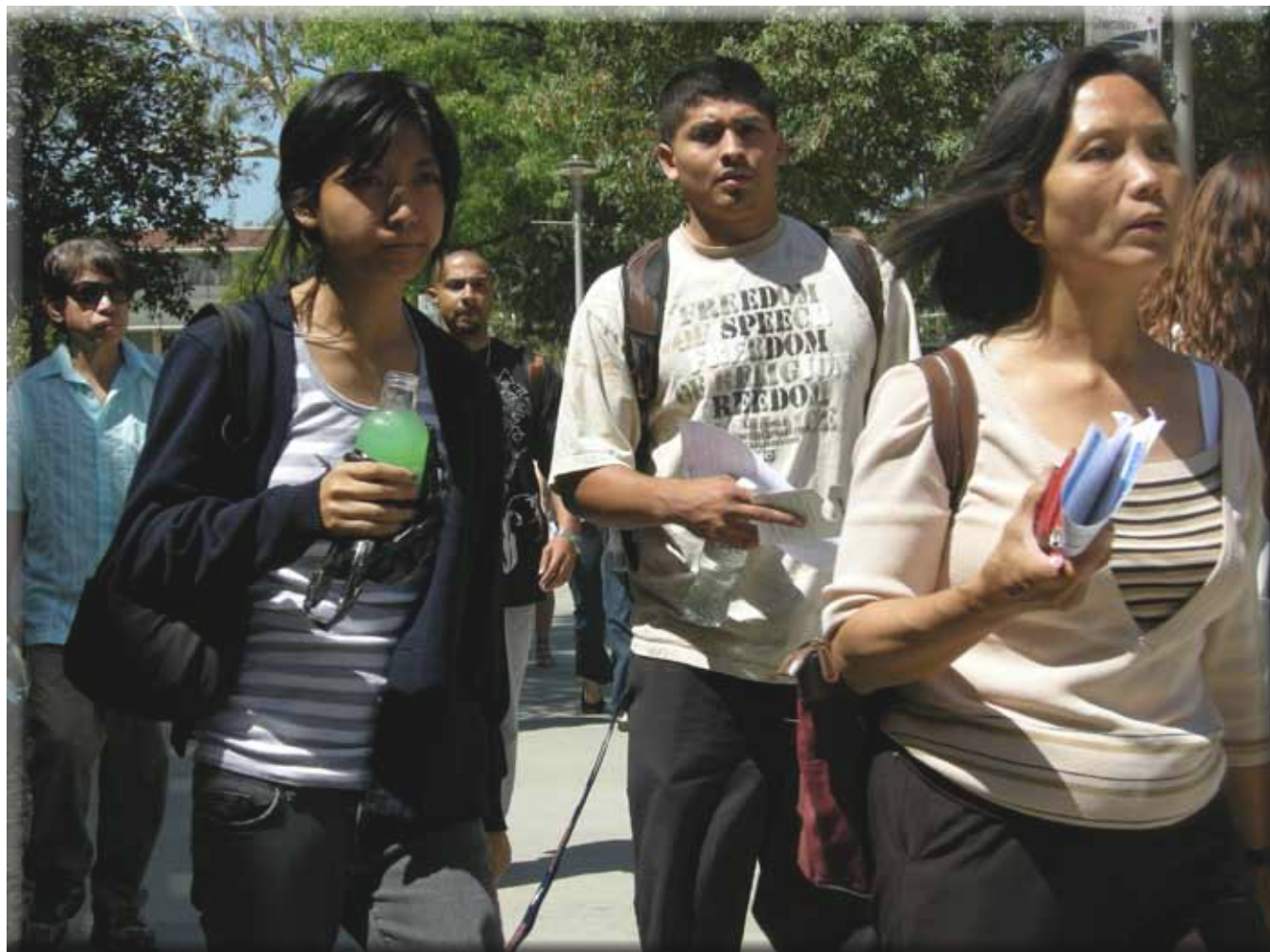

PROGRAMS & COURSES



ACCOUNTING

DEPARTMENT: BUSINESS ADMIN & CAOT

Accounting Degree: Associate of Arts Bookkeeping Certificate
 Degree: Associate of Arts Accounting Technician Certificate
 Automated Accounting Certificate

Producing
 Beginning Cinema & TV Production
 Cinema Post- Production
 Cinematography
 TV Studio Production - Level 1

Certificate
 Skill Certificate
 Skill Certificate
 Skill Certificate
 Skill Certificate

ADMINISTRATION OF JUSTICE

DEPARTMENT: LAW & ADMINISTRATION OF JUSTICE

Administration Of Justice Degree: Associate of Arts & Certificatee AJ - Certificate
 Specializing in Forensics
 Correctional Institution Officer Training Skill Certificate
 Evidence Technician/Forensics Skill Certificate
 Finger Print Classification Skill Certificate
 Fire Arms Training Skill Certificate
 Private Investigation Skill Certificate

COMPUTER APPLICATIONS & OFFICE TECHNOLOGY (CAOT)

DEPARTMENT: BUSINESS ADMIN & CAOT

Administrative Office Assistant Degree: Associate of Arts & Certificate
 Computer Applications Specialist Degree: Associate of Arts & Certificate Legal
 Office Assistant Degree: Associate of Arts & Certificate Medical
 Office Assistant Degree: Associate of Arts & Certificate Clerical Office
 Assistant Certificate
 Basic Administrative Office Assistant Skill Certificate
 Basic Computer Applications Skill Certificate
 Basic Legal Office Skill Certificate
 Basic Medical Administrative Skill Certificate
 Basic Medical Billing Skill Certificate
 Basic Medical Transcription Skill Certificate
 Basic Office Communications Skill Certificate
 Basic Web Page Design Skill Certificate
 Basic Word Processing Skill Certificate
 Web Page Design Skill Certificate

ARCHITECTURE

DEPARTMENT: ART

Architectural and Interior Skill Certificate
 Design and Computer Aided Skill Certificate
 Design and Drawing Skill Certificate
 Technical and Drawing Skill Certificate
 Architectural History Skill Certificate
 Architectural Graphics Skill Certificate

COMPUTER SCIENCES / INFORMATION TECHNOLOGY (CSIT)

DEPARTMENT: MATHEMATICS/ CSIT/CT/ET

Computer Science/Information Tech Degree: Associate of Science Computer
 Information Systems Degree: Associate of Science
 Applications Software Certificate
 Programming Languages Certificate
 Computer Networking Skill Certificate Database Administration
 Skill Certificate
 Operating Systems Skill Certificate
 UNIX Operating System Skill Certificate
 Web Client Technologies
 Skill Certificate
 Web Server Technologies
 Skill Certificate

ART

DEPARTMENT: ART

Art-General Degree: Associate of Arts
 Art- Graphic Design Degree: Associate of Arts

BUSINESS

DEPARTMENT: BUSINESS ADMINISTRATION

Advertising Degree: Associate of Arts
 Business Administration Degree: Associate of Arts & Certificate Finance
 & Banking Degree: Associate of Arts & Certificate
 Microcomputer Business Applications Certificate
 Also see Accounting, Finance, Management, Marketing

COMPUTER TECHNOLOGY

DEPARTMENT: MATHEMATICS/ CSIT/CT/ET

Computer Technology Degree: Associate of Science
 & Certificate
 CompTIAA+ Certification Skill Certificate
 CompTIA Network+ Certification Skill Certificate

CHEMISTRY

DEPARTMENT: CHEMISTRY

Chemistry - General Degree: Associate of Science

DENTAL TECHNOLOGY

DEPARTMENT: DENTAL TECHNOLOGY

Dental Technology Degree: Associate of Science & Certificate

CHICANO STUDIES

DEPARTMENT: AMERICAN CULTURES

Chicano Studies Degree: Associate of Arts

DIETETICS – FOOD PREP & NUTRITION

Dietetic Technician Degree: Associate of Science
 Dietetic Service Supervisor Certificate

CHILD DEVELOPMENT

DEPARTMENT: FAMILY & CONSUMER STUDIES

Child Development – Plan A Degree: Associate of Arts
 Child Development – Plan B Degree: Associate of Arts
 Child Development Teacher Certificate
 Child Dev Teacher Master Teacher Certificate
 Child Development Site Supervisor Certificate
 Child Development Associate Teacher Certificate of Achievement
 Children with Special Needs Skill Certificate
 Infant And Toddler Studies Skill Certificate
 School Age Programs Skill Certificate

ELECTRONICS

DEPARTMENT: MATHEMATICS/ CSIT/CT/ET

Electronic Systems Technology Degree: Associate of Science
 & Certificate
 Electronics - Basic Certificate

CINEMA

CINEMA/ TELEVISION

Cinema Production Degree: Associate of Arts & Certificate
 Television Production Degree: Associate of Arts & Certificate
 Video Production Certificate
 Directing Certificate

ENGINEERING

DEPARTMENT: PHYSICS

Engineering - General Degree: Associate of Science



ENGLISH

DEPARTMENT: ENGLISH/ E.S.L
English

Degree: Associate of Arts

FINANCE

DEPARTMENT: BUSINESS ADMIN & CAOT
Finance and Banking

Degree: Associate of Arts & Certificate

HUMANITIES

DEPARTMENT: FOREIGN LANGUAGE & HUMANITIES
Humanities

Degree: Associate of Arts

JOURNALISM

DEPARTMENT: MEDIAARTS
Journalism

Degree: Associate of Arts

LANGUAGES

DEPARTMENT: FOREIGN LANGUAGE & HUMANITIES

Chinese
French
Korean

Degree: Associate of Arts
Degree: Associate of Arts
Degree: Associate of Arts

Korean Lang and Civilization Inter.
Korean Lang and Civilization Adv.

Certificate (PENDING)
Certificate (PENDING)

Japanese
Spanish

Degree: Associate of Arts
Degree: Associate of Arts

LAW

DEPARTMENT: LAW & ADMINISTRATION OF JUSTICE

Paralegal Studies
Business Law

Degree: Associate of Arts
Degree: Associate of Arts

LIBERAL ARTS

DEPARTMENT: LIBERAL ARTS

Social and Behavioral Sciences
Natural Sciences and Mathematics
Arts and Humanities
Performing and Visual Arts
CSU GE
IGETC

Degree: Associate of Arts
Degree: Associate of Arts
Degree: Associate of Arts
Degree: Associate of Arts
Certificate
Certificate

MANAGEMENT

DEPARTMENT: BUSINESS ADMINISTRATION & CAOT

Management
Management – Business Offices
Management - Small Business
Marketing/Sales
Management - Retail

Degree: Associate of Arts & Certificate
Degree: Associate of Arts
Degree: Associate of Arts & Certificate
Degree: Associate of Arts & Certificate
Certificate

MATHEMATICS

DEPARTMENT: MATHEMATICS

Mathematics

Degree: Associate of Science

MUSIC

DEPARTMENT: MUSIC

Music Degree: Associate of Arts
Music Copyist
Music Technology
Orchestrator /Arranger
Vocal Performer
Instrumental Performer
Brass, Guitar, Organ, Percussion,

Certificate & Skill Certificates 1-4
Certificate & Skill Certificates 1-4
Certificate & Skill Certificates 1-4
Certificate & Skill Certificates 1-4
Certificate & Skill Certificates 1-4
Piano, Strings, Woodwinds

NURSING

DEPARTMENT: NURSING

Nursing, Registered
Certified Nurse Assistant
Home Health Aide

Degree: Associate of Science
Skill Certificate
Skill Certificate

PHOTOGRAPHY

DEPARTMENT: MEDIAARTS

Applied Photography
Photography - Commercial
Photography- Freelance

Degree: Associate of Arts
Certificate
Certificate

PHYSICS

DEPARTMENT: PHYSICS

Physics - General

Degree: Associate of Science

POLITICAL SCIENCE

DEPARTMENT: SOCIAL SCIENCE

Modern Political Studies

Degree: Associate of Arts

PSYCHOLOGY

DEPARTMENT: PSYCHOLOGY

Human Services- Generalist
Human Services- Drug/Alcohol

Degree: Associate of Arts & Certificate
Degree: Associate of Arts & Certificate

RADIOLOGIC TECHNOLOGY

DEPARTMENT: RADIOLOGIC TECHNOLOGY

Radiologic Technology

Degree: Associate of Science

REAL ESTATE

DEPARTMENT: REAL ESTATE

Real Estate
Real Estate- Finance Specialization
Real Estate- Investment Specialization
Real Estate- Marketing Specialization

Degree: Associate of Arts
Certificate
Certificate
Certificate

SOCIAL SCIENCE

DEPARTMENT: SOCIAL SCIENCE

African American Studies

Degree: Associate of Arts (PENDING)

TELEVISION (See Cinema)

THEATER

DEPARTMENT: THEATRE ARTS

Theater- General
Theatre Academy- Acting
Theatre Academy- Advanced Acting
Theatre Academy- Costuming
Theatre Academy- Technical Theater
Professional Actor Training
Professional Technical Theater
Professional Costuming Design

Degree: Associate of Arts
Degree: Associate of Arts
Degree: Associate of Arts
Degree: Associate of Arts
Degree: Associate of Arts
Certificate
Certificate
Certificate



ASSOCIATE OF ARTS DEGREE & CERTIFICATES



ADMINISTRATION OF JUSTICE & CORRECTIONS

Chair: Wilhelm Vargas, Attorney at Law
(323) 953-4000 ext. 2754 • HH200 F

www.lacitycollege.edu/academic/departments/law/index.html

PROGRAMS OFFERED

Associate of Arts:
Administration of Justice

State Certificates:
Administration of Justice -
Specializing in Forensics

Skill Certificates:
Correctional Officer Training
Evidence Specialist/Evidence Technician
Fingerprint Classification
Private Investigations

The Administration of Justice programs are designed to prepare students to enter careers as Police Officers, Deputy Sheriffs; Highway Patrol Offices; Forensic Specialists; Police Assistants; Fingerprint Experts; Custodial Officers; Probation/Parole Officers; Private Investigators; Insurance Investigators and Financial Investigators with private agencies. The programs are "hands-on" oriented to expose students to the fundamental concepts and tasks of law enforcement and ready them for employment. Additionally, our graduates are better prepared for the qualification and screening process required to enter law enforcement academies such as the Los Angeles Police Department Academy. Internship opportunities include: Los Angeles Police Department, Los Angeles Sheriff's Department, District Attorney's Office, Coroner's Office and Probation/Parole Offices.

In addition to being in high demand with plentiful opportunities for advancement, law enforcement professionals earn strong salaries. Officers typically earn more than support personnel. Patrol officers, on average, earn from \$51,000 and \$64,000.

DEGREE PROGRAM

ADMINISTRATION OF JUSTICE

Associate in Arts Degree

Career or Transfer Program

The Administration of Justice curriculum is offered by the Law Department to students who are interested in a career as a law enforcement officer or in a related field.

Plan A Students

Students planning to transfer should take the core units- plus Corrections 1. (This course may substitute for AJ 382) Consult with a College counselor for specific general education requirements and/or Graduation Requirements under "Plan A" for the Associate degree. Consult with the department chair for substitution of classes to meet core requirements.

Plan B Students

To complete Graduation Requirements "Plan B" for the Associate degree, 36 units of the courses listed below must be completed. Students must take the core units in Administration of Justice and may choose a specialization area such as: Correction Institutional Officer Training, Evidence Technician/Forensics or Private Investigation.

Students who have successfully completed academic training with local or state law enforcement agencies may receive Los Angeles City College credit for their Academy courses. These college credits may be applied toward a certificate in Administration of Justice or toward an Associate in Arts degree. These courses also transfer to CSULA as lower division requirements in the Criminal Justice major.

(CORE) - Plan A (Pending) UNITS ...

Administration of Justice 1.....	3
Administration of Justice 2.....	3
Administration of Justice 4.....	3
Administration of Justice 5.....	3
Administration of Justice 160.....	3
Corrections 1.....	3

Sub Total 18

COURSES (CORE)-Plan B UNITS

Administration of Justice 1.....	3
Administration of Justice 2.....	3
Administration of Justice 4.....	3
Administration of Justice 5.....	3
Administration of Justice 180.....	3
Administration of Justice 382.....	3

Sub Total 18

PLUS 15 units from ONE or more of the following specialty certificates below:

Correctional Officer Training

Skills Certificate

Corrections 1.....	3
Corrections 2.....	3
Corrections 5.....	3
Administration of Justice 14.....	3
Administration of Justice 16.....	3

(Plus 3 units of electives)

- OR -

Evidence Specialist

Administration of Justice 5 (CORE).....3
 Administration of Justice 180 (CORE).....3
 Administration of Justice 379.....3
 Administration of Justice 53.....3
 Administration of Justice 62.....3
 Administration of Justice 391.....3
 (Plus 6 units of electives)

-- OR -

Investigations

Skills Certificate

Administration of Justice 5 (CORE).....3
 Administration of Justice 14.....3
 Administration of Justice 180 (CORE).....3
 Administration of Justice 396.....3
 Administration of Justice 413.....3
 (Plus 9 units of electives)

Fingerprint Classification

Administration of Justice 53.....3
 Administration of Justice 62.....3
 (Plus 30 units of Electives)

List of Elective Units

Administration of Justice 4.....3
 Administration of Justice 6.....3
 Administration of Justice 8.....3
 Administration of Justice 14.....3
 Administration of Justice 16.....3
 Administration of Justice 39.....3
 Administration of Justice 53.....3
 Administration of Justice 60.....3
 Administration of Justice 62.....3
 Administration of Justice 379.....3
 Administration of Justice 381.....3
 Administration of Justice 390.....3
 Administration of Justice 391.....3
 Administration of Justice 396.....3
 Administration of Justice 413.....3

Students may select “PLAN A” or “Plan B” general education requirements to graduate.
 PLAN A: Please consult with a counselor about specific courses needed or see the college catalog “Graduation Requirements” section. Plan A is designed for transfer to a four-year college or university. However, requirements vary depending upon the individual institution. Please consult with a counselor for the specific requirements of the university you plan to attend.
 3-6 Units English Composition
 6-9 Units Communication/Analytical Thinking
 3 Units Natural Sciences
 3 Units Humanities
 9 Units Social/Behavioral Sciences (including American History & Governments)
 3-4 Units Health/Physical Education
 3-5 Units Math Competency
 (Math 115 or higher or passing score on Los Angeles Community College District Math competency exam)

PLAN B: Please consult with a counselor about specific courses needed or see the college catalog “Graduation Requirements” section. Plan B is not designed for transfer to a four-year college.
 3 Units English Composition
 3 Units Communication/Analytical Thinking
 3 Units Natural Sciences
 3 Units Humanities
 3 Units Social/Behavioral Sciences (including American History & Governments)
 3-4 Units Health/Physical Education
 3-5 Units Math Competency

CERTIFICATE PROGRAMS

ADMINISTRATION OF JUSTICE Certificate

The Certificate in Administration of Justice is designed to help prepare students to meet the employment requirements of law enforcement agencies or related fields including investigations. To qualify for a certificate, a student must complete the 18 core units described above plus 18 units from the listed electives equaling 36 units with a satisfactory grade of “C” or better in each course. The certificate will be issued by the Law Department upon application of the student with the department. Courses may be substituted with department chair’s approval.

Administration of Justice 1 (CORE)3
 Administration of Justice 2 (CORE)3
 Administration of Justice 3 (CORE).....3
 Administration of Justice 43
 Administration of Justice 5 (CORE).....3
 Administration of Justice 83
 Administration of Justice 143
 Administration of Justice 163
 Administration of Justice 533
 Administration of Justice 603
 Administration of Justice 623
 Administration of Justice 673
 Administration of Justice 180 (CORE).....3
 Administration of Justice 3793
 Administration of Justice 3813
 Administration of Justice 382 (CORE).....3
 Administration of Justice 390.....3
 Administration of Justice 3913
 Administration of Justice 3963
 Administration of Justice 4133

ADMINISTRATION OF JUSTICE - SPECIALIZING IN FORENSICS Certificate

The Administration of Justice curriculum offers a specialty in forensics for students who are interested in a career in law enforcement, as an officer, criminalist, or as a civilian employee with duties as an evidence technician, fingerprint specialist, property custodian, or police assistant who investigates traffic accidents and writes reports. This program in Forensics is designed to help prepare students to meet the employment requirements of law enforcement agencies or private firms. It is also intended to provide students interested in the criminalist field (crime lab) with “hands-on” training by criminalists as well as direct contact with these professionals as a counseling tool. Courses may be substituted with department chair’s approval. To qualify for a certificate, a student must complete 39 units from the Forensic Option, within the Administration of Justice program, with a satisfactory grade or better in each course. The certificate will be issued by the Law Department upon application by the student with the department.

Administration of Justice 1.....3
 Administration of Justice 3.....3
 Administration of Justice 5.....3
 Administration of Justice 14.....3
 Administration of Justice 180.....3
 Administration of Justice 379.....3
 Administration of Justice 380.....3
 Administration of Justice 53.....3
 Administration of Justice 62.....3
 Administration of Justice 391.....3
 Administration of Justice 396.....3
 Photography 10 or Administration of Justice 2*.....3

*If your career goal is Police Officer, take Administration of Justice 2. If your career goal is Evidence Specialist or other specialist, take Photography 10.
 Total Units.....36

CORRECTIONAL OFFICER TRAINING

Skill Certificate

This certificate is designed for students interested in employment in corrections-City Jailers, County Custody Assistants, State Prison Correctional Officers, Probation Officers and Parole Officers. Specialized training in the different correctional institutions, inmate rights, and inmate supervision will provide students with the knowledge that will enhance employment opportunities and career goals.

Corrections 13
 Corrections 23
 Corrections 53
 Administration of Justice 14.....3
 Administration of Justice 16.....3
Total Units 15

EVIDENCE SPECIALIST

Skill Certificate

The Forensics curriculum provides training for students interested in a career as an Evidence Specialist/Evidence Technician or related fields such as a police assistant. Students completing the Skill Certificate program will be qualified to assume a variety of employment opportunities in crime scene investigations with Federal, State, and Local Law Enforcement Agencies.

Administration of Justice 5.....3
 Administration of Justice 180.....3
 Administration of Justice 379.....3
 Administration of Justice 53.....3
 Administration of Justice 62.....3
 Administration of Justice 391.....3
Total Units 18

FINGER PRINT CLASSIFICATION

Skill Certificate

Upon completion of the fingerprint classification course, students will receive a certificate that qualifies them to take the state fingerprint examination, which is required for the position of Finger Identification Expert. This course is approved by the California State Chancellor's Office.

Administration of Justice 53..... 3
 Administration of Justice 62 3
Total Units 6

INVESTIGATIONS

Skill Certificate

This certificate is designed to give those students interested in private investigations the necessary skills to perform the needed work for private investigation firms, insurance companies, state agencies, business and others. Traffic accident investigations and identity crime investigations such as: driver license, credit card, and Social Security are examples of topics that will be covered in this program.

Administration of Justice 53
 Administration of Justice 143
 Administration of Justice 1803
 Administration of Justice 3963
 Administration of Justice 413
Total Units15

**AMERICAN CULTURES SOCIAL
 SCIENCE ANTHROPOLOGY
 - SEE SOCIAL SCIENCE**



ARCHITECTURE

Chair: Gayle Partlow
(323) 953-4000 ext. 2510 • DH220

PROGRAMS OFFERED

Courses Only - Skill Certificates:

- Architectural and Interior Design Computer Aided Design and Drawing
- Technical Drawing
- Architectural History
- Architectural Graphics

LACC has a new and exciting Architecture Program with three primary objectives: 1) To prepare students for admissions and transfer into accredited architecture schools; 2) To prepare students with sufficient skills and knowledge for the job market in architecture, interior design, construction management, and construction; 3) To provide information and insight for those who simply want to learn something about architecture and design. We offer a full range of architectural courses, including instruction on the use of CAD and computer 3-D modeling as part of the design and drawing process.

The architectural profession is a very exciting field and currently is very strong. For more information, contact Wayne Chiu at chiuwy@lacitycollege.edu for more information and/or consultation.

CERTIFICATE PROGRAMS

**ARCHITECTURAL AND INTERIOR DESIGN
 Certificate**

A certificate in Architectural Design will be issued by the Art/Architecture Department upon application of the student with the Department Chair upon successful completion of the courses listed below. All courses must be taken at LACC and completed with a satisfactory grade.

ENV 1013
 ENV 1023
 ARC 2013
 ARC 2023
 ARC 2223
Total Units 15

COMPUTER AIDED DESIGN AND DRAWING

Skill Certificate

A certificate in Computer Aided Design and Drawing will be issued by the Art/Architecture Department upon application of the student with the department upon successful completion of the courses listed below. All courses must be taken at LACC and completed with a satisfactory grade.

ARC 162.....	3
ARC 172.....	3
ARC 173.....	3
ENV 101.....	3
ENV 102.....	3

Total Units15

TECHNICAL DRAWING

Skill Certificate

A skills certificate in Technical Drawing will be issued by the Art/Architecture Department upon successful completion of the courses listed. All courses must be taken at LACC and completed with a satisfactory grade.

ARC 172.....	3
ARC 173.....	3
ARC 271.....	3
ARC 272.....	3
ARC 162.....	3

Total Units15

ARCHITECTURAL HISTORY

Skill Award

A skill certificate in Architectural History will be issued by the Art/Architecture Department upon successful completion of the courses listed. All courses must be taken at LACC and completed with a satisfactory grade.

ARC 130.....	2
ARC 131.....	2
ENV 101.....	3
ENV 102.....	3

Total Units 10

ARCHITECTURAL GRAPHICS

Skill Certificate

A skill certificate in Architectural Graphics will be issued by the Art/Architecture Department upon successful completion of the courses listed. All courses must be taken at LACC and completed with a satisfactory grade.

ARC 221.....	3
ARC 222.....	3
ENV 101.....	3
ENV 102.....	3
ARC 162.....	3

Total Units 15

The above core consists of the minimum of art courses to be taken for transfer. Please see a counselor for specific university major preparation. As many institutions require a portfolio, students should plan to develop a portfolio with instructor guidance. Courses may be substituted under special circumstances with departmental approval.



ART

Chair: Gayle Partlow
(323) 953-4000 ext. 2510 • DH220
www.lacitycollege.edu/academic/departments/art/index.html

PROGRAMS OFFERED

Associate of Arts:

- Art - General
- Art - Graphic Design

The Los Angeles City College Art Department is committed to offering an extensive program of courses for students whose goals range from a career in fine arts or graphic design to those pursuing personal enrichment. We offer the AA degree in Fine Arts and Graphic Design as well as two year programs aimed at transfer to the University of California and California State University systems. Our students may also choose private schools such as University of Southern California, Art Center College of Design, and Otis College of Art and Design, Woodbury University, and Fashion Institute of Design & Merchandising.

Our faculty of working professionals teach art as both a subject and an activity. Our courses provide a foundation in visual knowledge and theory and training in the techniques of art-making. We recognize the uniqueness of the individual and encourage exploration of her/his creative talents by emphasizing art experience and potential in a diversity of cultures. The relationships among the arts are emphasized and enrollment is encouraged in other arts disciplines.

DEGREE PROGRAMS

The Art Department offers two Associate in Arts Degrees: Art/General and Art/Graphic Design. Note that Art/General - Plan A is for students planning to transfer to a four-year college, university or art school. Plan B for Art/General or Art/Graphic Design is for students wanting an AA degree Career Program.

**ART/GENERAL
Associate of Arts Degree
Transfer Program**

Art Core for Transfer Program

60 units minimum with at least 18 units in the following core program

--To complete general education requirements in this area of study, Plan A for the AA/AS Degree is required.

PLAN A: Please consult with a counselor about specific courses needed or see the college catalog "Graduation Requirements" section. Plan A is designed for transfer to a four-year college or university. However, requirements vary depending upon the individual institution. Please consult with a counselor for the specific requirements of the university you plan to attend.

- 3-6 Units English Composition
- 6-9 Units Communication/Analytical Thinking
- 3 Units Natural Sciences

3 Units	Humanities
9 Units	Social/Behavioral Sciences (including American History & Governments)
3-4 Units	Health/Physical Education
3-5 Units	Math Competency

(Math 115 or higher or passing score on Los Angeles Community College District Math competency exam)

ART/GENERAL

Associate of Arts Degree

Career Program

The following is a suggested plan for completing the courses for Plan B Associate in Arts Degree in two years. Please note that the requirements for Plan A are not necessarily required for Plan B. As career opportunities are limited for art students with only an Associate in Arts degree, the Art Department strongly advises continuing training at a four-year college, university, or art school. Students are expected to develop a portfolio with instructor guidance.

First Semester

Art 201	3
Art 501	3
Art 101 or 102	3

Second Semester

Art 202 or 204	3
Art 300, 304 or 307	3
Art 101 or 102	3

Third Semester

Art 111	3
Art 502	3
Art 700 or 708	3

Fourth Semester

Art 633	3
Art 300, 304 or 307	3
Art 700 or 708	3

Total Units36

Suggested electives: Art 105, 107, 109, 202, 209, 400, 503, 620, 634, Photography 10

To complete general education requirements in this area of study, Plan B for the AA/AS Degree is required.

PLAN B: Please consult with a counselor about specific courses needed or see the college catalog

"Graduation Requirements" section. Plan B is not designed for transfer to a four-year college.

3 Units	English Composition
3 Units	Communication/Analytical Thinking
3 Units	Natural Sciences
3 Units	Humanities
3 Units	Social/Behavioral Sciences (including American History & Governments)
3-4 Units	Health/Physical Education
3-5 Units	Math Competency

ART/GRAPHIC DESIGN

Associate of Arts Degree

Career Program

This program provides the foundation for careers in computer graphics, advertising design, commercial illustration and desktop publishing. The creative and practical aspects of visual communication are equally stressed, with an emphasis on contemporary trends. Digital work is grounded in fundamental art skills and methods. Students enrolled in the program will utilize the Art Department's Macintosh computer labs. Students can expect to develop a sound, entry-level portfolio.

First Semester

Art 633	3
Art 201	3
Art 501	3

Second Semester

Art 604	3
Art 620	3
Art 101, 102 or 111	3

Third Semester

Art 204 or 209	3
Art 605	3
Art 639	3

Fourth Semester

Art 204 or 209	3
Art 606	3
Art 634	3

Total Units36

Suggested Electives: Art 101, 102, 111, 202, 304, 400, 502, 503; Photography 10; Cinema 1; Marketing 1

To complete general education requirements in this area of study, Plan B for the AA/AS Degree is required.

PLAN B: Please consult with a counselor about specific courses needed or see the college catalog

"Graduation Requirements" section. Plan B is not designed for transfer to a four-year college.

3 Units	English Composition
3 Units	Communication/Analytical Thinking
3 Units	Natural Sciences
3 Units	Humanities
3 Units	Social/Behavioral Sciences (including American History & Governments)
3-4 Units	Health/Physical Education
3-5 Units	Math Competency



BIOLOGY/ANATOMY

Chair: Greg Gonsalves, Life Science
(323) 953-4000 ext.2796•LS204
www.lacitycollege.edu/academic/departments/lifesci/index.html

PROGRAMS OFFERED
Courses Only - No Degree/Certificate
Anatomy Biology Microbiology Physiology

Students considering careers in health and medicine are required to take courses in the Biology/Anatomy discipline. Many health and allied health programs (e.g. Radiologic Technology, Pharmacy, Physical Therapy, etc.) require Anatomy and Physiology. Some programs, Nursing for example, also require Microbiology. Students in non-health care related majors can also benefit from a grounding in these areas. For instance, the non-major's Biology 3 course meets the IGETC (transfer) laboratory requirement. Additionally, understanding basic biological principles can help you live a healthier life and better understand diseases, medical treatments, and medical breakthroughs. All LACC Biology/Anatomy classes are UC and CSU transferable.



**BUSINESS
ADMINISTRATION**

Chair: Dr. Thelma Day
(323) 953-4000 ext. 2549 • AD304

www.lacitycollege.edu/academic/departments/busad/business.htm

PROGRAMS OFFERED

Associate of Arts:

- Accounting
- Advertising
- Bookkeeping
- Business Administration
- Business Law (See "Law")
- Finance & Banking
- Management
- Management, Business Office
- Management, Small Businesses
- Marketing
- Real Estate

Certificates:

- Accounting Technician
- Automated Accounting
- Business Administration
- Business Micro-Computer Application
- Finance & Banking
- Management
- Management, Small Business
- Management, Retail
- Marketing
- Real Estate - Finance, Investment & Marketing Specializations

Our Business, Accounting and Real Estate programs will give students a solid foundation from which to advance to university Bachelor degree and MBA programs. For students who do not plan to go on to a university, LACC business programs will prepare you for entry level and supervisory positions in a variety of roles for a wide range of businesses. Employment opportunities include bookkeeper, sales, ad agency staffer, office manager, supervisor, banking and investment staffer, marketing department staff and real estate agent. The business courses are also ideal for students considering starting their own businesses or those who already own small business. Even students not planning to major in business will find taking courses in the subject to be useful. Virtually every organization must manage people, finances and other resources, and do some level of marketing. Additionally, every organization relies on outside businesses to function.

DEGREE PROGRAMS

ACCOUNTING

**Associate of Arts Degree
Career Program**

Designed for students who are interested in a career in accounting, in private industry, or in public service, or who may choose to become accounting technicians with a public accounting firm. Students who already possess a Bachelor's degree and contemplate preparing for the Certified Public Accountant certificate should contact the State Board of Accountancy for eligibility requirements. Their website address is: <http://dca.ca.gov/cba>. The curriculum outlined below is for students who do not intend to transfer to a four year college or university. Transfer students should consult the transfer requirements in the Transfer Requirements section, elsewhere in this catalog.

REQUIRED COURSES

First Semester

Accounting 1.....	5
Accounting 55.....	1
Business 1.....	3
Accounting 31 or Business 38.....	3

Second Semester

Accounting 2.....	5
Accounting 17 or 18.....	2/3
Supervision 1.....	3
Accounting 23.....	3

Following Semesters

Accounting 25 or 27.....	3
Management 31.....	3
CSIT 101 or 103.....	4
Finance 2.....	3
Business 17.....	3
Accounting 15.....	3
Business 15.....	3

Total Units 47-48

Suggested General Education Electives: Supervision 1; Management 2; Finance 8, 15; Law 1.

To complete general education requirements in this area of study, Plan B for the AA/AS Degree is required.

PLAN B: Please consult with a counselor about specific courses needed or see the college catalog

"Graduation Requirements" section. Plan B is not designed for transfer to a four-year college.

3 Units English Composition

3 Units	Communication/Analytical Thinking
3 Units	Natural Sciences
3 Units	Humanities
3 Units	Social/Behavioral Sciences (including American History & Governments)
3-4 Units	Health/Physical Education
3-5 Units	Math Competency

ADVERTISING

Associate of Arts Degree

Career Program

Designed by the Business Administration Department, this program is for students who wish to enter the advertising field. It offers training leading to employment as an advertising salesperson, copywriter, layout technician, or re- search production employee.

REQUIRED COURSES

Business 1.....	3
Marketing 1.....	3
Marketing 21.....	3
Art 103.....	3
Marketing 11.....	3
Marketing 13.....	1
CSIT 101 or 103.....	4
Business 17.....	3
Management 31.....	3
Management 33.....	3
International Business 1.....	3
Electives: Accounting 21 and 41.....	4

Total Units..... 33-37

To complete general education requirements in this area of study, Plan B for the AA/AS Degree is required.

PLAN B: Please consult with a counselor about specific courses needed or see the college catalog

"Graduation Requirements" section. Plan B is not designed for transfer to a four-year college.



3 Units	English Composition
3 Units	Communication/Analytical Thinking
3 Units	Natural Sciences
3 Units	Humanities
3 Units	Social/Behavioral Sciences (including American History & Governments)
3-4 Units	Health/Physical Education
3-5 Units	Math Competency

BOOKKEEPING

Associate of Arts Degree

Career Program

The Business Administration department has designed the Bookkeeping curriculum for students who wish to become bookkeepers in private industry or government service. It is so arranged that students forced to terminate their schooling after completing one, two, or three semesters will have acquired skills necessary for employment. Students expecting to serve in the Armed Forces will find this a suitable preparation for many military classifications. Students who wish to become public accountants should take the Accounting curriculum.

REQUIRED COURSES

First Semester

Accounting 21 and 41.....	4
Accounting 31 or Business 38.....	3
Business 1.....	3
Management 13.....	3

Second Semester

Accounting 17 or 18.....	2/3
Accounting 22 and 42.....	4
Accounting 23.....	3

Following Semesters

Accounting 25 or 27.....	3
Finance 8.....	3
Management 31.....	3
Accounting 15.....	3
Supervision 1.....	2
Elective (see below).....	3

Total Units..... 36-40

Suggested General Education Electives: Accounting 27 or 55, Business 10, CSIT 130, CSIT 133, Finance 2, 15, CAOT 1, Management 2.

To complete general education requirements in this area of study, Plan B for the AA/AS Degree is required.

PLAN B: Please consult with a counselor about specific courses needed or see the college catalog

"Graduation Requirements" section. Plan B is not designed for transfer to a four-year college.

3 Units	English Composition
3 Units	Communication/Analytical Thinking
3 Units	Natural Sciences
3 Units	Humanities
3 Units	Social/Behavioral Sciences (including American History & Governments)
3-4 Units	Health/Physical Education
3-5 Units	Math Competency

BUSINESS ADMINISTRATION

Associate of Arts Degree

Career Program

The Business Administration curriculum is designed for students who are interested in an encompassing, formal business education. Upon successful completion of this program, the student will have an extensive background in the principles and practices of the business world.

REQUIRED COURSES

First Semester

Business 1.....	3
Business 38 or Accounting 31.....	3
Management 31.....	3
Management 33.....	3

Second Semester

Finance 83
 Marketing 113
 Management 23

Third Semester

Business 153
 Business 173
 Marketing 213

Fourth Semester

Accounting 21 and 414
 Management 133
 Supervision 13

Total Units 40

To complete general education requirements in this area of study, Plan B for the AA/AS Degree is required.

PLAN B: Please consult with a counselor about specific courses needed or see the college catalog

"Graduation Requirements" section. Plan B is not designed for transfer to a four-year college.

- 3 Units English Composition
- 3 Units Communication/Analytical Thinking
- 3 Units Natural Sciences
- 3 Units Humanities
- 3 Units Social/Behavioral Sciences (including American History & Governments)
- 3-4 Units Health/Physical Education
- 3-5 Units Math Competency

FINANCE & BANKING

**Associate of Arts Degree
 Career Program**

The Finance and Banking curriculum has been planned by the Business Administration department to provide training for employment in such fields as banking, corporate finance, stocks and bonds, credits and collections, and savings and loan businesses.

REQUIRED COURSES

First Semester

Business 13
 Business 38 or Accounting 313
 Management 313

Second Semester

Accounting 21 and 414
 Finance 83
 Business 173
 Supervision 13

Following Semesters

Accounting 22 and 424
 Finance 23
 Finance 153
 Real Estate 13
 Management 23

Total Units38

To complete general education requirements in this area of study, Plan B for the AA/AS Degree is required.

PLAN B: Please consult with a counselor about specific courses needed or see the college catalog

"Graduation Requirements" section. Plan B is not designed for transfer to a four-year college.

- 3 Units English Composition
- 3 Units Communication/Analytical Thinking
- 3 Units Natural Sciences
- 3 Units Humanities

- 3 Units Social/Behavioral Sciences (including American History & Governments)
- 3-4 Units Health/Physical Education
- 3-5 Units Math Competency

MANAGEMENT

**Associate of Arts Degree
 Career Program**

The Management curriculum has been planned by the Business Administration Department for students going into business for themselves or for those who are ambitious to advance to positions of leadership in any organization.

REQUIRED COURSES

First Semester

Business 13
 Business 383
 Management 23

Second Semester

Accounting 21 and 414
 Supervision 13
 International Business 13

Third Semester

Accounting 22 and 42
 (for those who have already completed Accounting 21 and 41)..4
 CSIT 101 or Business 174
 Finance 83

Fourth Semester

Management 133
 Management 333

Total Units36

To complete general education requirements in this area of study, Plan B for the AA/AS Degree is required.

PLAN B: Please consult with a counselor about specific courses needed or see the college catalog

"Graduation Requirements" section. Plan B is not designed for transfer to a four-year college.

- 3 Units English Composition
- 3 Units Communication/Analytical Thinking
- 3 Units Natural Sciences
- 3 Units Humanities
- 3 Units Social/Behavioral Sciences (including American History & Governments)
- 3-4 Units Health/Physical Education
- 3-5 Units Math Competency

MANAGEMENT - BUSINESS OFFICES

**Associate of Arts Degree
 Career Program**

The Business Administration department has planned the Business Office Management curriculum for students who aspire to the middle management positions in business and industry concerned with the administration of general business offices and the supervision of office personnel. To help train students for these positions, the curriculum offers courses in the various functions of office services.

REQUIRED COURSES

First Semester

Accounting 21 and 414
 Business 13
 Business 383

Second Semester

Finance 23
 Accounting 253
 Management 133

Third Semester

Business 173
 Finance 83
 Finance 15.....3

Fourth Semester

Management 2.....3
 Management 31.....3
 Management 33.....3
 Supervision 13

Total Units 40

To complete general education requirements in this area of study, Plan B for the AA/AS Degree is required.

PLAN B: Please consult with a counselor about specific courses needed or see the college catalog

"Graduation Requirements" section. Plan B is not designed for transfer to a four-year college.

- 3 Units English Composition
- 3 Units Communication/Analytical Thinking
- 3 Units Natural Sciences
- 3 Units Humanities
- 3 Units Social/Behavioral Sciences (including American History & Governments)
- 3-4 Units Health/Physical Education
- 3-5 Units Math Competency

MANAGEMENT - SMALL BUSINESS

**Associate of Arts Degree
 Career Program**

The Business Administration department has planned the Small Business Management curriculum for those students preparing to be an employee in a small business or planning to own a business.

REQUIRED COURSES

First Semester

Accounting 21 and 414
 Business 13
 Finance 63
 Management 13.....3
 Management 33.....3

Second Semester

International Business 13
 Marketing 113

Following Semesters

CSIT 101 or 1034
 Finance 23
 Management 2.....3
 Management 31.....3
 Supervision 1.....3

Total Units41

To complete general education requirements in this area of study, Plan B for the AA/AS Degree is required.

PLAN B: Please consult with a counselor about specific courses needed or see the college catalog

"Graduation Requirements" section. Plan B is not designed for transfer to a four-year college.

- 3 Units English Composition
- 3 Units Communication/Analytical Thinking
- 3 Units Natural Sciences
- 3 Units Humanities
- 3 Units Social/Behavioral Sciences (including American History & Governments)
- 3-4 Units Health/Physical Education
- 3-5 Units Math Competency

MARKETING

**Associate of Arts Degree
 Career Program**

The Marketing degree program provides the student with a wide range of knowledge in marketing, selling, advertising and retailing, as well as decision-making skills in product planning, pricing, and selection of channels of distribution. The capstone

course, Marketing 21, provides student with a vehicle for making contacts in the field of marketing with a view toward employment.

The Marketing curriculum shown below serves as a guide to students majoring in the subject area. Students have flexibility in scheduling these classes but are advised to begin their studies with Principles of Marketing (Marketing 21) .

REQUIRED COURSES

First Semester

Marketing 13
 Marketing 213
 Business 13
 Management 31.....3

Second Semester

Marketing 113
 Marketing 13.....1
 Business 383
 Management 33.....3
 Business 173

Following Semesters

Management 13.....3
 Management 2.....3
 Supervision 13
 Marketing 313

Total Units37

To complete general education requirements in this area of study, Plan B for the AA/AS Degree is required.

PLAN B: Please consult with a counselor about specific courses needed or see the college catalog

"Graduation Requirements" section. Plan B is not designed for transfer to a four-year college.

- 3 Units English Composition
- 3 Units Communication/Analytical Thinking
- 3 Units Natural Sciences
- 3 Units Humanities
- 3 Units Social/Behavioral Sciences (including American History & Governments)
- 3-4 Units Health/Physical Education
- 3-5 Units Math Competency

REAL ESTATE

**Associate of Arts Degree
 Career Program**

The Real Estate curriculum has been designed by the Business Administration department for students who plan to enter the real estate field in such areas as sales, brokerage, management, and escrows. Individuals who complete all class requirements listed below in a chosen Real Estate program with a satisfactory grade or better in each course may apply for a Real Estate Certificate. Applications are distributed in the Real Estate classes at approximately the middle of each semester. Applications should be filed with the Graduation Clerks in the Admissions Office during the semester in which the program is expected to be completed. Education and experience requirements for the broker license are set by the California Department of Real Estate. For more information please contact the Los Angeles District Office Branch is located at: 320 W. 4th Street, Suite 350; Los Angeles, CA 90013-1105; (213)620-2072

REQUIRED COURSES

Real Estate 13
 Real Estate 33
 CSIT 101 or Business 174/3
 Communications Course3
 Real Estate 53
 Real Estate 73
 Accounting 15
 Real Estate 63
 Real Estate 93
 Real Estate 113
 Real Estate 143
 Real Estate 183
 Real Estate 213
 Law 13
 Marketing 13

Total Units48/47

Refer to prerequisites for Accounting 1. Suggested General Education Electives: Real Estate 60; Marketing 21; CSIT 130. Advanced courses for practicing real estate agents are suggested as follows: CSIT 130 (word processing, data base, spreadsheet) Real Estate 60. Real Estate 60 is also recommended for pre licensing students.

To complete general education requirements in this area of study, Plan B for the AA/AS Degree is required.

PLAN B: Please consult with a counselor about specific courses needed or see the college catalog.

“Graduation Requirements” section. Plan B is not designed for transfer to a four-year college.

- 3 Units English Composition
- 3 Units Communication/Analytical Thinking
- 3 Units Natural Sciences
- 3 Units Humanities
- 3 Units Social/Behavioral Sciences (including American History & Governments)
- 3-4 Units Health/Physical Education
- 3-5 Units Math Competency

CERTIFICATE PROGRAMS

ACCOUNTING TECHNICIAN Certificate

A Certificate in Accounting-Technician will be issued by the Business Administration department upon submittal of an application by the student to the department after successful completion of the following course work with a satisfactory grade.

REQUIRED

Accounting 21 & 41	4
Accounting 22 & 42	4
Accounting 15.....	3
Accounting 17.....	2
Accounting 23.....	3
Accounting 55.....	1
Management 31.....	3
Marketing 31.....	3
Accounting 31 or Business 38.....	3
Business 17.....	3
Accounting 25 or 27.....	3

Total Units.....32

AUTOMATED ACCOUNTING Certificate

A certificate in Automated Accounting will be issued by the Department of Business Administration upon submittal of an application by the student to the department after successful completion of requirements for Accounting-Technician certificate and completion of the following course work with a satisfactory grade.

REQUIRED

Accounting 21 & 41	4
Accounting 22 & 42	4
Accounting 17.....	2
Accounting 23.....	3
Accounting 25 or 27.....	3/3
Accounting 31 or Business 38.....	3/3
Accounting 55.....	1
Business 1.....	3
Business 17.....	3
Marketing 21.....	3
Accounting 15.....	3

Total Units.....32-33

BUSINESS ADMINISTRATION CERTIFICATE

A certificate in Business Administration will be issued by the Business Administration department after submittal of an application to the department by the student after successful completion of the following course work with a satisfactory grade. This curriculum is designed for students who are interested in entering the general business field in Management, Marketing, International Business, and Finance.

Business 1.....	3
Business 1.....	3
Business 38.....	3
CSIT 101 or CSIT 103 or Business 17.....	4/4/3
Finance 2 or 8.....	3/3
Management 2 or 31.....	3/3
Supervision 12.....	3
International Business 1.....	3
Marketing 21.....	3
Accounting 21 & 41.....	4

Total Units.....31-32

All courses must be completed with a satisfactory grade or better.

BUSINESS-MICRO COMPUTER APPLICATION CERTIFICATE

A certificate in Business Micro-Computer Application will be issued by Business Administration department upon submittal of an application by the student to the department with successful completion of the following course work with a satisfactory grade.

Business 1.....	3
Business 17 or CSIT 133.....	3
CSIT 104 or Business 38.....	3
CSIT 130.....	3
CSIT 148 or CSIT 133.....	3
CSIT 157 or CSIT 160.....	4/3
CSIT 167.....	3
Marketing 11 or Marketing 21.....	1/3
Management 2 or Management 31 or 33.....	3
CAOT 84.....	3

Total Units.....27-28

FINANCE & BANKING CERTIFICATE

A certificate in Finance and Banking will be issued by the Business Administration department upon submittal of an application by the student to the department after successful completion of the following course work with a satisfactory grade.

Accounting 21 & 41	4
Accounting 55.....	1
Finance 15.....	3
Business 1.....	3
Business 38 or Accounting 31.....	3
CSIT 101 or CSIT 103 or Business 17.....	4/4/3
Finance 2.....	3
Finance 8.....	3
Management 31.....	3
Supervision 1 or Management 13.....	3
Business 15.....	3

Total Units.....32-33

All courses must be completed with a satisfactory grade or better.

MANAGEMENT CERTIFICATE

A certificate in Management will be issued by the Business Administration department upon submittal of an application by the student to the department upon successful completion of the courses listed below. This curriculum is designed for students who are planning on going into business for themselves or to advance into leadership positions within an organization.

Business 38.....	3
Business 1.....	3
CSIT 101 or CSIT 103 or Business 17.....	4/4/3
Finance 2.....	3
Supervision 12.....	3
Management 2.....	3
Management 13.....	3
Management 31.....	3
Management 33.....	3
Marketing 21.....	3
Supervision 1.....	3
Total Units	33-34

SMALL BUSINESS MANAGEMENT CERTIFICATE

A certificate in Small Business Management will be issued by the Business Administration department upon submittal of an application by the student to the department after successful completion of the following course work with a satisfactory grade.

Accounting 21 & 41 or Accounting 23.....	4/3
Business 1.....	3
Business 38 or Accounting 31.....	3
CSIT 101 or 103 or Business 17.....	4/4/3
Supervision 12.....	3
Management 13.....	3
Management 31.....	3
Management 33.....	3
Marketing 1.....	3
Marketing 11.....	3
Finance 8.....	3
Total Units.....	33-35

RETAIL MANAGEMENT Certificate

This curriculum prepares students for management careers in the retail industry. Emphasis is on retail merchandising, human relations, human resource management, communications, and computer applications. Curriculum was developed in cooperation with the Western Association of Food Chains.

Marketing 21.....	3
Marketing 31.....	3
Management 2.....	3
Management 31.....	3
Management 33.....	3
Business 38.....	3
Speech 101.....	3
Supervision 12.....	3
CAOT 84 or CAOT 85.....	3
Accounting 21 & 41.....	4
Accounting 22 & 42.....	4
Total Units.....	35

MARKETING Certificate

The Marketing certificate has been designed to provide the student with a vehicle for acquiring valuable knowledge, expertise, and marketable skills with which to obtain employment — or to attain promotions — in sales, marketing, retailing, advertising, or new product planning. The student will also learn the means of succeeding in businesses of their own, without having to complete the related and elective units of study required for the Associate of Arts degree.

Business 1.....	3
Business 38 or Accounting 31.....	3
Supervision 12.....	3
CSIT 101 or Business 17.....	4/3
International Business 6.....	3
Management 13 or 31.....	3
Management 6 or Supervision 1.....	3
Marketing 1.....	3
Marketing 11.....	3
Marketing 21.....	3
Marketing 31.....	3
Total Units.....	33-34

REAL ESTATE CERTIFICATE WITH SPECIALIZATION CORE

Real Estate 1.....	3
Real Estate 3.....	3
Real Estate 5.....	3
Real Estate 7.....	3
Real Estate 9.....	3
CSIT 101 or CSIT 103.....	4
Business 1.....	3
Core Courses Sub-Total.....	22

Additional required courses for the specializations are: Real Estate: Finance Specialization

ADDITIONAL REQUIRED COURSES

Real Estate 6.....	3
Real Estate 11.....	3
Real Estate 21.....	3
Finance 2.....	3
Finance 8.....	3
Sub-Total	15

Total (Core + Specialization).....37

REAL ESTATE: INVESTMENT SPECIALIZATION

ADDITIONAL REQUIRED COURSES

Real Estate 11.....	3
Real Estate 14.....	3
Real Estate 18.....	3
Real Estate 21.....	3
Finance 2.....	3
Finance 8.....	3
Sub-Total.....	18

Total (Core + Specialization).....40

REAL ESTATE: MARKETING SPECIALIZATION

ADDITIONAL REQUIRED COURSES

Real Estate 6.....	3
Real Estate 11.....	3
Real Estate 14.....	3
Marketing 1.....	3
Marketing 11.....	3
Marketing 21.....	3
Sub-Total.....	18

Total (Core + Specialization).....40

All courses must be completed with a satisfactory grade or better. This certificate satisfies the statutory college course requirement necessary for the California Real Estate Broker license. A college degree and/or additional experience is also required.

Please consult with the California Department of Real Estate.



CAOT Computer Application and Office Technologies

Chair: Dr. Thelma Day
(323) 953-4000 ext. 2549 • AD304

<http://caot.lacitycollege.edu>

PROGRAMS OFFERED

Associate of Arts:
Administrative Office Assistant
Computer Applications Specialist
Legal Office Assistant
Medical Office Assistant

Certificates:

Administrative Office Assistant
Clerical Office Assistant
Computer Applications Specialist
Legal Office Assistant
Medical Office Assistant
Basic Certificates of Completion
Basic Administrative Office Assistant
Basic Computer Applications
Basic Legal Office
Basic Medical Administrative
Basic Medical Billing
Basic Medical Transcription
Basic Office Communications
Basic Web Page Design
Basic Word Processing
Web Page Design

This curriculum offers the student a wide variety of options, which may lead to a certificate and/or an Associate of Arts degree. The Certificate program will prepare the student to work closely with management and various types of business, professional, educational, or industrial offices. The student may receive the Associate of Arts degree to ensure upward mobility in the chosen field of employment. Students interested in obtaining an Associate of Arts degree, Plan B, must complete graduation requirements for the Plan B.

Please consult a counselor early in your program for appropriate general education courses.

The Specialty Certificates are designed for students who do not wish to receive an Associate of Arts degree. The Computer Applications And Office Technologies certificate program prepares the student for positions such as: Administrative Office Assistant, Computer Applications Specialist, Legal Office Assistant, Medical Office Assistant and, Word Processing Specialist.

DEGREE PROGRAMS

COMPUTER APPLICATION & OFFICE TECHNOLOGIES

Associate of Arts Degree Career Program

The following Core courses are required for all Computer Applications & Office Technologies Associate of Arts degrees (required for all Associate of Arts degrees)

REQUIRED CORE COURSES

CAOT 1, 2, or 3	3
CAOT 31	3
CAOT 32	3
CAOT 84	3
Total Core Units	12

All students pursuing an Associate of Arts Degree must complete the core courses plus additional courses indicated below.

ADMINISTRATIVE OFFICE ASSISTANT Associate of Arts Degree

Career Program

REQUIRED COURSES

Core Courses above PLUS the following courses:

CAOT 3	3
CAOT 43	3
CAOT 79 or 112	3
CAOT 85	3
CAOT 88	3
CAOT 97	3
CAOT 98	3
Subtotal	21
Total Units (Core + Specialization)	33

Suggested Electives: CAOT 9, 34, or 64

To complete general education requirements in this area of study, Plan B for the AA/AS Degree is required.

PLAN B: Please consult with a counselor about specific courses needed or see the college catalog

"Graduation Requirements" section. Plan B is not designed for transfer to a four-year college.

3 Units	English Composition
3 Units	Communication/Analytical Thinking
3 Units	Natural Sciences
3 Units	Humanities
3 Units	Social/Behavioral Sciences (including American History & Governments)
3-4 Units	Health/Physical Education
3-5 Units	Math Competency

COMPUTER APPLICATIONS SPECIALIST
Associate of Arts Degree
Career Program

REQUIRED COURSES

Core Courses above PLUS the following courses:

CAOT 79	3
CAOT 82	3
CAOT 85	3
CAOT 88	3
CAOT 97	3
CAOT 98	3
CAOT 112	3
Subtotal	21

Total Units (Core + Specialization)33

Suggested Electives: CAOT 9, 34, or 64

To complete general education requirements in this area of study, Plan B for the AA/AS Degree is required.

PLAN B: Please consult with a counselor about specific courses needed or see the college catalog

"Graduation Requirements" section. Plan B is not designed for transfer to a four-year college.

3 Units	English Composition
3 Units	Communication/Analytical Thinking
3 Units	Natural Sciences
3 Units	Humanities
3 Units	Social/Behavioral Sciences (including American History & Governments)
3-4 Units	Health/Physical Education
3-5 Units	Math Competency

LEGAL OFFICE ASSISTANT
Associate of Arts Degree
Career Program

REQUIRED COURSES

Core Courses above PLUS the following courses:

CAOT 3	3
CAOT 23	5
CAOT 43 or Law 14	3
CAOT 49	3
CAOT 82 or CAOT 85	3
CAOT 93	2
LAW 1	3
Total Units	22

Total Units (Core + Specialization)34

Suggested Electives: CAOT 9, 34, or 64

To complete general education requirements in this area of study, Plan B for the AA/AS Degree is required.

PLAN B: Please consult with a counselor about specific courses needed or see the college catalog

"Graduation Requirements" section. Plan B is not designed for transfer to a four-year college.

3 Units	English Composition
3 Units	Communication/Analytical Thinking
3 Units	Natural Sciences
3 Units	Humanities
3 Units	Social/Behavioral Sciences (including American History & Governments)
3-4 Units	Health/Physical Education
3-5 Units	Math Competency

MEDICAL OFFICE ASSISTANT
Associate of Arts Degree
Career Program

REQUIRED

12 units from Core Courses above PLUS the following courses

CAOT 3 or 9	3/1
CAOT 20	5
CAOT 43	3
CAOT 44	3
CAOT 46	3
Biology 25	3
Subtotal	18-20
Total Units (Core + Specialization)	30-32

Suggested Electives: CAOT 9, 34, or 64

To complete general education requirements in this area of study, Plan B for the AA/AS Degree is required.

PLAN B: Please consult with a counselor about specific courses needed or see the college catalog

"Graduation Requirements" section. Plan B is not designed for transfer to a four-year college.

3 Units	English Composition
3 Units	Communication/Analytical Thinking
3 Units	Natural Sciences
3 Units	Humanities
3 Units	Social/Behavioral Sciences (including American History & Governments)
3-4 Units	Health/Physical Education
3-5 Units	Math Competency

CERTIFICATE PROGRAMS

The Computer Applications and Office Technologies Programs offers a variety of certificates to students interested in working closely with management and various types of businesses, professional, educational, or industrial offices. Specialty Certificates will prepare the student for positions such as: Administrative Office Assistant, Computer Applications Specialist, Legal Office Assistant, Medical Office Assistant, and Word Processing Specialist.

ADMINISTRATIVE OFFICE ASSISTANT

Specialty Certificate

REQUIRED

CAOT 3	3
CAOT 43	3
CAOT 79 or 112	3
CAOT 84	3
CAOT 85	3
CAOT 88	3
CAOT 97	3
CAOT 98	3

Total Units24

CLERICAL OFFICE ASSISTANT

Certificate

REQUIRED

CAOT 2	3
CAOT 7	3
CAOT 31	3
CAOT 32	3
CAOT 33	2
CAOT 47	2
CAOT 82	3
CAOT 105	2
CAOT 106	3

Total Units24

COMPUTER APPLICATIONS SPECIALIST

Specialty Certificate

REQUIRED

CAOT 14	2
CAOT 79	3
CAOT 82	3
CAOT 84	3
CAOT 85	3
CAOT 86	3
CAOT 88	3
CAOT 97	3
CAOT 98	3
CAOT 112	3

Total Units29

LEGAL OFFICE ASSISTANT
Specialty Certificate
REQUIRED
 CAOT 3 3
 CAOT 23 5
 CAOT 43 or Law 14 3
 CAOT 49 3
 CAOT 82 or 85 3
 CAOT 84 3
 CAOT 93 2
 Law 1 3
Total Units **25**

MEDICAL OFFICE ASSISTANT
Specialty Certificate
REQUIRED
 CAOT 3 3
 CAOT 20 5
 CAOT 43 3
 CAOT 44 3
 CAOT 46 3
 CAOT 84 3
 CAOT 97 3
 Biology 25 3
Total Units **26**

BASIC ADMINISTRATIVE OFFICE ASSISTANT
Certificate of Completion
REQUIRED
 CAOT 43 3
 CAOT 85 3
Total Units **6**

BASIC COMPUTER APPLICATIONS
Certificate of Completion
REQUIRED
 CAOT 97 3
 CAOT 98 3
Total Units **6**

BASIC LEGAL OFFICE
Certificate of Completion
REQUIRED
 CAOT 23 5
 CAOT 93 2
Total Units **7**

BASIC MEDICAL ADMINISTRATIVE
Certificate of Completion
REQUIRED
 CAOT 2 3
 CAOT 20 5
 CAOT 44 3
Total Units **11**

BASIC MEDICAL BILLING
Certificate of Completion
REQUIRED
 CAOT 33 2
 CAOT 44 3
 CAOT 126 3
Total Units **8**

BASIC MEDICAL TRANSCRIPTION
Certificate of Completion
REQUIRED
 CAOT 2 3
 CAOT 44 3
 CAOT 46 3
Total Units **9**

BASIC OFFICE COMMUNICATIONS
Certificate of Completion
REQUIRED
 CAOT 32 3
 CAOT 31 3
 CAOT 34 2
Total Units **8**

BASIC WEB PAGE DESIGN
Certificate of Completion
REQUIRED
 CAOT 84 3
 CAOT 112 3
Total Units **6**

WEB PAGE DESIGN
Certificate of Completion
REQUIRED
 CAOT 112 3
 CSIT 151 4
Total Units **7**

BASIC WORD PROCESSING
Certificate of Completion
REQUIRED
 CAOT 3 3
 CAOT 79 3
 CAOT 84 3
Total Units **9**



Department of Chemistry & Earth Sciences

Chair: John Freitas

**Department of Chemistry and
Earth Sciences**

(323) 953-4000 ext. 2600 • SCI 324B

www.lacitycollege.edu/academic/departments/chemistry/chemweb

**PROGRAMS OFFERED Associate of
Science: Chemistry - General**

Everything in the world involves chemistry. The air you breathe, the food you eat, and the blood coursing through your veins all involve chemistry. It involves the snow on the mountains, the gasoline you put in your car, and the batteries used to run your iPod.

A background in chemistry is essential to many high-paying, challenging careers in health care, technology, consumer industries, environmental management and more including: Pharmaceuticals, Forensic Science, Petroleum Industry, Food Technology, Cosmetics and so much more.

All chemistry courses offered at Los Angeles City College are designed to transfer to state and national university systems. Chemistry meets a general education requirement for most university majors, particularly: Premedical, Pre-Dental, Nursing, Anthropology, Biology, Chemistry, Geology, Physics and Pharmacy.

DEGREE PROGRAM

CHEMISTRY- GENERAL

Associate of Science Degree (Pending State Approval)

Transfer Program

This Associate of Science degree provides the student with preparatory course work, allowing transfer to a four-year university as a junior in chemistry or related physical sciences. Individuals who earn the degree with a major in chemistry will find many desirable entry-level jobs in chemistry and manufacturing.

First Semester

Chemistry 101	5
Mathematics 261	5
General Education	6

Second Semester

Chemistry 102.....	5
Mathematics 262	5
Physics 101	5

Third Semester

Chemistry 211.....	5
Physics 102	5
General Education.....	6

Fourth Semester

Chemistry 212.....	5
General Education	9

Total Units.....61

Note: One Chemistry or Physics course and one Math course can be applied to the Plan A general education requirement.

To complete general education requirements in this area of study, Plan A for the AA/AS Degree is required.

PLAN A: Please consult with a counselor about specific courses needed or see the college catalog "Graduation Requirements" section. Plan A is designed for transfer to a four-year college or university.

However, requirements vary depending upon the individual institution. Please consult with a counselor for the specific requirements of the university you plan to attend.

3-6 Units English Composition

6-9 Units Communication/Analytical Thinking

3 Units Natural Sciences

3 Units Humanities

9 Units Social/Behavioral Sciences (including American History & Governments)

3-4 Units Health/Physical Education

3-5 Units Math Competency

(Math 125 or higher or passing score on Los Angeles Community College District Math competency exam)



CHILD DEVELOPMENT

Chair: Kathleen Bimber

(323) 953-4000 ext. 2290 • CD201

Vice Chair: Cheryl Werble

(323) 953-4000 ext. 2292 • CD208

www.lacitycollege.edu/academic/departments/childdev/index.html

PROGRAMS OFFERED

Associate of Arts:

Child Development - Transfer

Child Development - Vocational

(2 & 3 year plans)

Certificates:

Child Development Associate Teacher

Child Development Teacher

Child Development Master Teacher

Child Development Site Supervisor

Skill Certificates:

Infant & Toddler Studies

School Age Programs

Children with Special Needs

Program Mission:

The mission of the Child Development program is to provide learners with multiple pathways that prepare them to become dynamic, responsive, authentic, and informed early childhood education professionals.

Child Development certificates and degrees provide students with the coursework and the field experience needed for a career in Early Childhood Education. LACC’s Child Development curriculum is aligned with the state’s permit matrix to prepare students for positions in early. Students are trained as educators for a variety of private and public early childhood education programs including Head Start, State Pre-School, and school early care and education center programs. Graduates teach or administer in programs for infants, pre-schoolers, school-age children, and children with special needs in before- and after- school programs. Many students begin their career as assistant teachers, and with additional coursework and experience, move up the career ladder to head teachers or site supervisors. Professionals in this field can expect to make between \$20,000 - \$40,000 annually. Those who continue their education at a four-year university can typically increase their earnings to the mid-\$50,000 range.

DEGREE PROGRAMS

Students wishing to prepare for employment in early childhood programs, and those currently employed may select several alternative patterns of study in the Child Development Program. The curriculum prepares students to teach or administer programs for young children, including: Private Early Childhood Programs, Head Start, other publicly supported programs, Infant and School Age Programs, inclusion programs and children with special needs.

Courses allow the student to prepare for increasingly higher levels of employment and certification. It is possible to prepare for the educational requirements of the State Department of Social Services, the California Child Development Permit, the Associate in Arts Degree in Child Development or the Transfer Program. Students wishing to transfer to California State University Los Angeles may inquire in the department office (CD 201) about the AA to BA cohort transfer program. The AA to BA program is specifically designed to support students to achieve their transfer educational goals.

PLANNING AHEAD:

- Mantoux test: Some Child Development courses may require you to obtain a Mantoux test for Tuberculosis. The college Health Center provides this service. Please call ahead for days and times the Health Center provides this service.
- Criminal Clearance: In order to fulfill State licensing requirements for employment in private and public programs you must receive a Criminal Clearance to work with young children. Consult with faculty for additional information.
- CPR Class: Your employer may require you to take a 15 hour Cardiopulmonary Resuscitation class. This class covers training on basic first aid for infants and children, CPR techniques as well as information on basic health and sanitation procedures.

NOTE: Course work in Child Development may be accepted from an accredited college in the United States toward major requirements for an Associate in Arts degree under the following conditions:

- Course work from the outside college is based on a semester system or equivalent.
- Course work is equivalent to an LACC Child Development course. Approved course work may apply for the Child Development Associate in Arts degree but not toward certificate requirements.
- The course work may not be used to satisfy Child Development Certificate requirements if courses are not from the Los Angeles Community College District.

CDTC:

- If you are currently working in a paid position in a licensed Early Childhood Program serving infants to kindergarten, or before and after school-age

programs, and are taking Child Development or General Education units towards a Child Development Permit, you may qualify for partial reimbursement of your fees, books, or other expenses at LACC. For information, ask for the Child Development Training Consortium in CD 201 or call (323) 953 – 4000 ext. 2290 or CD 201 at ext. 2296

TANF CDC:

- If you are currently in the CalWORKS program and receiving TANF cash aid, you may qualify for our TANF-CDC (Temporary Assistance for Needy Families – Child Development Careers) cohort program. Students prepare to become and Associate Teacher or Teacher through the CA Child Development permit process. Student participants receive the following services: one-to-one education and career advisement, payment of books and tuition, bus passes, materials and supplies for your courses, free access to all department workshops, as well as TANF – CDC workshops such as resume writing, dress for success, CPR training, Play Power and much more. For more information, ask for the TANF CDC in LRC 104P-2 or call Leticia Campoy, at (323) 953 – 4000, ext. 2298.

DEGREE PARTNERSHIP PROGRAM

LACC & California State University Los Angeles (CSULA) are now partnering to offer you a seamless educational AA to BA experience right here at LACC. Three years at LACC, then complete the last year at CSULA

**PLAN A OPTIONS
CHILD DEVELOPMENT - “PLAN A”
Associate of Arts Degree
Transfer Program**

Program Descriptions:

Completion of the Associate Degree, Plan A prepares students for transfer to a university and for employment in an early care and education program. Students develop skills, knowledge, and attitudes that prepares them to work as teachers of young children or as administrators of ECE programs.

60 units minimum with at least 18 units in Child Development.

Note: Co-requisites or Advisories of English 21 or 73 and 28 or 31, or equivalent, are required for many Child Development courses.

REQUIRED

Child Development 1	3
Child Development 2	3
Child Development 7	3
Child Development 10.....	3
Child Development 11	3
Child Development 22.....	4
Child Development 34.....	3
Child Development 42.....	3
Total Units.....	28
Suggested electives (required by CSULA)	
CD 30	3
FCS 31	3

NOTE:

- Some courses may be offered every other semester, or less frequently, or alternating day and evening. All students must receive a satisfactory grade.
- CSULA accepts CD 1, CD 11, CD 22, CD 30 and CD 34. It is recommended that students take these courses prior to transfer to CSULA. CSULA will also accept CD 3 and CD 4 or CD 7 from students enrolled in the Child Development AA to BA transfer cohort program.
- FCS 31 is also accepted by CSULA and is requirement for the major.

It is suggested students take this class as one of their G.E. courses

To complete general education requirements in this area of study, Plan A for the AA/AS Degree is required.

PLAN A: Please consult with a counselor about specific courses needed or see the college catalog "Graduation Requirements" section. Plan A is designed for transfer to a four-year college or university. However, requirements vary depending upon the individual institution. Please consult with a counselor for the specific requirements of the university you plan to attend.

- 3-6 Units English Composition
 - 6-9 Units Communication/Analytical Thinking
 - 3 Units Natural Sciences
 - 3 Units Humanities
 - 9 Units Social/Behavioral Sciences (including American History & Governments)
 - 3-4 Units Health/Physical Education
 - 3-5 Units Math Competency
- (Math 115 or higher or passing score on Los Angeles Community College District Math competency exam)

CHILD DEVELOPMENT - "PLAN A"
(2-YEAR PLAN)
Associate of Arts Degree
Transfer Program

FIRST YEAR COURSES

Fall Semester

- Child Development 1
- Child Development 2
- English 28/31 (Co-requisites for CD 2)
- Child Development 11
- English 21/73 (Co-requisites for CD 1 and 11)

Spring Semester

- Child Development 10
- Child Development 34
- Child Development 7

SECOND YEAR COURSES

Fall Semester

- Child Development 7
- Choose one from below:
- Child Development 30 or FCS 31

Spring Semester

- Child Development 3 or 4 or 7 (choose the curriculum class not taken in the previous semester)
- Elective-choose one: recommend CD 10, 22 or 30 or 34.

To complete general education requirements in this area of study, Plan A for the AA/AS Degree is required.

PLAN A: Please consult with a counselor about specific courses needed or see the college catalog "Graduation Requirements" section. Plan A is designed for transfer to a four-year college or university. However, requirements vary depending upon the individual institution. Please consult with a counselor for the specific requirements of the university you plan to attend.

- 3-6 Units English Composition
 - 6-9 Units Communication/Analytical Thinking
 - 3 Units Natural Sciences
 - 3 Units Humanities
 - 9 Units Social/Behavioral Sciences (including American History & Governments)
 - 3-4 Units Health/Physical Education
 - 3-5 Units Math Competency
- (Math 115 or higher or passing score on Los Angeles Community College District Math competency exam)

PLAN B OPTIONS
CHILD DEVELOPMENT - "PLAN B"
Associate of Arts Degree
Career Program

60 units with at least 36 units in Child Development.

REQUIRED

Child Development 1	3
Child Development 2	3
Child Development 10	3
Child Development 11	3
Child Development 22	4
Child Development 23	4
Child Development 65	2

AND 6 units of curriculum from Child Development 3 and 4 (prior to Spring 2010) OR 7 and 8 (Spring 2010 on)

6

Subtotal - Core Units **28**

Plus 8 Electives Units: Select additional courses from below to complete 36 units in the major.

Note: If working toward your Master Teacher Permit or LACC's Certificate 3 - Master Teacher, refer to Specialization Options section under Certificate 3 - Master Teacher for electives that satisfy the specialization requirement.

Child Development 30	3
Child Development 31	3
Child Development 34	3
Child Development 35	3
Child Development 38	3
Child Development 39	3
Child Development 42	3
Child Development 44	3
Child Development 45	3
Child Development 46	3
Child Development 47	3
Child Development 48	3
Child Development 53	3
Child Development 84	0.5
Child Development 85	0.5
Family & Consumer Studies 21	3
Family & Consumer Studies 31	3
English 218	3
Music 130	3
Music 146	3

Consult with the department regarding specialization options to satisfy AA degree Plan B and Certificate 3 requirements.

- Note that some courses may be offered every other semester, or less frequently, or alternating day and evening.
- All students must receive a satisfactory grade or better.

To complete general education requirements in this area of study, Plan B for the AA/AS Degree is required.

PLAN B: Please consult with a counselor about specific courses needed or see the college catalog

"Graduation Requirements" section. Plan B is not designed for transfer to a four-year college.

- 3 Units English Composition
- 3 Units Communication/Analytical Thinking
- 3 Units Natural Sciences
- 3 Units Humanities
- 3 Units Social/Behavioral Sciences (including American History & Governments)
- 3-4 Units Health/Physical Education
- 3-5 Units Math Competency

CHILD DEVELOPMENT - “PLAN B”**(2-Year Plan For Full-Time Students) Associate of Arts Degree****Career Program**

Students with the objective of completing the Certificate Program in 2 years must be eligible for English 28/31, or have appropriate placement on the College Assessment, their first semester in order to meet course prerequisites or advisories. To receive a certificate students must have completed English 28 or 31 or equivalent with a satisfactory grade or have appropriate placement on the College Assessment.

FIRST YEAR COURSES**Fall Semester**

Child Development 1
Child Development 2
English 28 or 31 (Co-requisite for CD 2)
Child Development 11

Spring Semester

Child Development 3 or 4 (prior to 2010) or CD 7 (2010)
Child Development 10
Child Development elective (select from electives listed above or from Specialization Options listed in Certificate 3-Master Teacher)
Child Development 84/85 (optional labs that provides support for CD 2, 3, 4, 22, 23, 30, 31, 35, 42, 44, 45, 46, 47 and other courses)

SECOND YEAR COURSES**Fall Semester**

Child Development 4 or 8 (2010)
Child Development 22
Take 3 units from electives listed above or in Certificate 3-Master Teacher OR Take CD 38 if working toward Site Supervisor Certificate

Spring Semester

Child Development 23
Child Development 65
Take 3 units from electives listed above or in Certificate 3 - Master Teacher or Take CD 39 if working toward Site Supervisor Certificate

To complete general education requirements in this area of study, Plan B for the AA/AS Degree is required.

PLAN B: Please consult with a counselor about specific courses needed or see the college catalog

“Graduation Requirements” section. Plan B is not designed for transfer to a four-year college.

3 Units	English Composition
3 Units	Communication/Analytical Thinking
3 Units	Natural Sciences
3 Units	Humanities
3 Units	Social/Behavioral Sciences (including American History & Governments)
3-4 Units	Health/Physical Education
3-5 Units	Math Competency

CHILD DEVELOPMENT - “PLAN B”**(3-Year Plan For Part-Time Students)****Associate of Arts Degree****Career Program****FIRST YEAR COURSES****Fall Semester**

Child Development 1
English 21/73 (Co-requisite for CD 1 & 11)
Child Development 11

Spring Semester

Child Development 2
English 28/31 (Co-requisite for CD 2)
Child Development 10

SECOND YEAR COURSES**Fall Semester**

Child Development 3 or 4 (prior to 2010) OR CD 7 (2010)
Child Development 84 (optional lab course designed to support CD 3, 4, 22 & 23 and other courses)
Take 3 units from electives listed in Certificate 3 - Master Teacher OR
Take CD 38 if working toward Site Supervisor Certificate (offered fall only)

Spring Semester

Child Development 3 or 4 or 7
Take 3 units from electives listed in Certificate 3 - Master Teacher OR Take CD 39 if working toward the Site Supervisor Certificate (offered spring only) Child Development 84/85 (optional lab courses designed to support CD 2, 3, 4, 22, 23, 30, 31, 35, 42, 44, 45, 46, 47 and other courses)

THIRD YEAR COURSES**Fall Semester**

Child Development 22
Take 3 units from electives listed in Certificate 3 - Master Teacher.

Spring Semester

Child Development 23
Take CD 65 if working toward Certificate 3 - Master Teacher.

To complete general education requirements in this area of study, Plan B for the AA/AS Degree is required.

PLAN B: Please consult with a counselor about specific courses needed or see the college catalog

“Graduation Requirements” section. Plan B is not designed for transfer to a four-year college.

3 Units	English Composition
3 Units	Communication/Analytical Thinking
3 Units	Natural Sciences
3 Units	Humanities
3 Units	Social/Behavioral Sciences (including American History & Governments)
3-4 Units	Health/Physical Education
3-5 Units	Math Competency

CERTIFICATE PROGRAMS

The Certificate in Child Development will be issued by the Family & Consumer Studies/Child Development Department after completing requirements with at least a “C” grade in courses taken within 10 years. Students must also complete English 28 or 31 or higher or may satisfy this requirement through appropriate placement on the College Assessment, in order to qualify for most certificates. The student may obtain the application for a certificate from the Family & Consumer Studies/Child Development Department. Applications must be returned to the Admissions Office by the 9th week of the Fall and Spring semesters. Students with courses in progress must pick up an “In Progress” form from CD 201, obtain instructor signatures and return it to the office by the 9th week. Students applying for Certificates with course work in progress will receive their official certificate upon verification of a satisfactory grade.

NOTE: Students with the objective of completing the Certificate Program in 2 years must be eligible for English 28 or 31, their first semester in order to meet course prerequisites or advisories. Students may also satisfy this English requirement through the appropriate placement on the College Assessment.

NOTE: All Child Development “core” courses for Skill Certificate 1 - Associate Teacher must be taken at LACC or another college in the Los Angeles Community College District.

CHILD DEVELOPMENT-ASSOCIATE TEACHER

Certificate 1 (pending State approval)

This skill certificate is the first step on the early childhood career ladder. Recipients of this certificate meet the minimum State requirements to teach in a private preschool, or school-age program, and with the addition of CD 30, infant program. With work experience, students may qualify for the California Child Development Permit: Associate Teacher level.

12 Child Development units plus 3 units in English

REQUIRED

Child Development 1	3
Child Development 2	3
English 28/31	3
Child Development 11	3
Child Development 3 OR 4	3

Total Units..... 15

- Note: co-requisite or advisory requirements for Eng. 21 or 73 & 28 or 31 for above classes. You may also satisfy this requirement through appropriate placement on the College Assessment.
- To qualify for Title 22, Director, take above core units and CD 38 Administration & Supervision of Early Childhood Programs I.

CHILD DEVELOPMENT- TEACHER

Certificate 2

This certificate, along with 16 general education units and work experience make the recipient eligible for the California Child Development Permit: Teacher level. Recipients of this certificate may teach in private or public preschool, school-age programs, and with the addition of CD 30, infant programs.

12 Child Development units from Certificate 1, plus 3 units English

PLUS REQUIRED

Child Development 3 or 4	3
(whichever course not taken in Certificate 1)	
Child Development 10	3
Child Development 22	4
Child Development 23	4

Total Units..... 29

Note: To complete requirements for a California Child Development Permit at Teacher level, add 16 general education units including Humanities, Social Science, Math/Science and English. Consult with a Counselor regarding general education requirements.

CHILD DEVELOPMENT-MASTER TEACHER

Certificate 3

This certificate enables the recipient to not only teach, but also to supervise other child development teachers and staff. Some responsibilities of the Master Teacher might include: developing and implementing age-appropriate curriculum within a safe, healthy and stimulating environment, supervision of classroom staff, creating positive communication links with parents, school and community. Additionally, the Master Teacher Certificate is designed to meet the requirements for the major and for the Associate in Arts degree in Child Development, Plan B. Students interested in transferring to a four year institution should follow Plan A transfer requirements. With work experience and 16 general education units, students may also qualify for the California Child Development Permit: Master Teacher level. This level permit is the gateway to the CA Early Childhood Mentor Program.

36-38 Child Development units

Meets requirements for Plan B Associate in Arts Major in Child Development.

(To complete the General Education requirements for AA degree, consult with a Counselor.)

Note: To meet the requirements for Master Teacher Certificate, students will have completed units from Certificate 2 and need to complete additional specialization elective units to total 37 Child Development units. (See specialization elective units. Specialization units are also required for if students wish to obtain the CA Child Development Permit: Master Teacher level.)

29 units from Certificate 2 (includes English 28), **PLUS**

Child Development 65	2
6 Specialization units	
(refer to specialization options below)	6
Total Units.....	37

SPECIALIZATION OPTIONS

(Consult with Child Development faculty for other specialization options.)

Choose 2 courses from the same sequence below:

Child Development 30 and 31	3/3
Child Development 44 and 45	3/3
Child Development 46 and 47	3/3
Child Development 48 and 53 or FCS 31	3/3
Child Development 10 and FCS 21	3/3

Note: if you choose CD 10 for this specialization you will need to replace 3

units in certificate 2 by choosing another elective.

Child Development 42 and Music 147	3/3
Music 130 and Music 147	3/3

CHILD DEVELOPMENT SITE SUPERVISOR

Certificate 4

This certificate is the highest certificate offered by the Child Development program. Recipients of this certificate are qualified to supervise an entire program at one site. Some responsibilities of site supervisors include the following: use of positive leadership skills to implement the sites' philosophy, adherence to state and federal licensing requirements, budget implementation, enforcement of enrollment/ registration policies and procedures, hire, in- spire and supervise all staff, foster positive communication links between home, school and community, maintain appropriate health, safety and nutrition standards, supervision of curriculum and schedule development. Students wishing to obtain the California Child Development Permit: Site Supervisor level, must meet experience requirements, obtain an Associate in Arts degree, and meet the requirements listed below.

29 units from Certificate 2, plus 3 Units of English, **PLUS**

Child Development 38	3
Child Development 39	3
Child Development 65	2

Total..... 37

CHILD DEVELOPMENT

SPECIALIZATION SKILL CERTIFICATES

The following certificates are designed for students interested in specializing in a particular field of study such as: infant/toddlers, school-age, or children with special needs. Note: English 21/73 or 28/31 are co-requisites for most courses and may be satisfied through placement on the College Assessment.

INFANT & TODDLER STUDIES

Skill Certificate

The Infant & Toddler Studies skill certificate qualifies the student for the most entry-level teacher position within private infant/toddler programs. Infant/Toddler teachers are responsible for supervising the care and development of children birth through 2 ½ years old. Some responsibilities may include: developing and sustaining caring, loving, respectful relationships, designing developmentally age- appropriate curriculum, organizing parent conferences and establishing clear daily communications with parents and other caregivers.

Child Development 30	3
Child Development 31	3
Child Development 1	3
Child Development 10 or 34	3
Child Development 11	3

Note: English 28 is a prerequisite for CD 34

Total Units..... 15

SCHOOL AGE PROGRAMS

Skill Certificate

This skill certificate qualifies students for the an entry level teacher position within school-age programs. School-age program teachers work with children from kindergarten through middle school, in before and/or after school programs. Some responsibilities might be to design and implement develop- mentally age-appropriate activities that are fun exciting and challenging to a variety of age groups. Note: English 28 or equivalent is required in order to receive any LACC Child Development certificate.

Child Development 46	3
Child Development 47	3
Child Development 1	3
Child Development 11	3
ADD one elective chosen from the following courses:	
Child Development 48	3 or
Child Development 42	3 or
Child Development 44	3 or
Child Development 45	3 or
English 218.....	3 or
Music 146	3 or
Total Units.....	15

CHILDREN WITH SPECIAL NEEDS

Skill Certificate

This skill certificate qualifies students for an entry level teacher or assistant position in a program with children who have special needs. Students gain skills in accommodating and adapting the physical environment, instructional strategies and curriculum to meet the needs of differently abled children and their families.

Child Development 44	3
Child Development 45	3
Child Development 1	3
Child Development 11	3
ADD one elective chosen from the following courses:	
Child Development 10	3 or
Child Development 34	3 or
Child Development 42	3 or
Child Development 48	3 or

Total Units15



**CINEMA/
TELEVISION**

Chair: Vaughn Obern
(323) 953-4000 ext. 2627 • CC181

<http://cinematv.lacitycollege.edu>
Email: obernvg@lacitycollege.edu

PROGRAMS OFFERED

**Associate of Arts: Cinema Production
Television Production**

Certificates:

**Cinema Production Cinema/Video
Production Television Production**

Skill Certificates:

**Beginning Cinema & Television Production
Cinema Post-Production Cinematography
Directing
Producing
TV Studio Production - Level I**

For those attracted to telling a story in pictures, defining and refining images and sound, or for those who want to join the world of entertainment - behind the scenes - a career in cinema and television production could be just right. The opportunities and professional areas in which to work are varied. Large and small film studios, television production companies, product and service companies, public and private organizations, and individuals all use cinema/television professionals. Positions include Camera Operator, Audio Technician, Film/TV Floor Positions, Lighting Technician, Photographer, Film/ Video Editor, Cinematographer and Director. Assignments encompass full-length films; shorts; animation; entertainment television or news; documentaries; commercials; informational, web content, promotional or private videos; portraits and commercial photography; and much more. Salaries also range widely, but average from \$35,000 - \$200,000+ annually.

The LACC Cinema & Television Department provides its students with the history, principles, technical competency and hands on training needed to work successfully in cinema or television production. Many of our students successfully go from LACC into the industry. For others who wish to go after a Bachelors degree, the skills and work product obtained at LACC will help them be more competitive candidates for acceptance into top four-year universities.

DEGREE PROGRAMS

CINEMA PRODUCTION

The Cinema-Television Department offers two Associate of Arts Degrees

"Plan A" is for students planning to transfer to a four-year college or university.
"Plan B" is a training program in motion picture production.

CINEMA PRODUCTION – "PLAN A"

Associate of Arts Degree Transfer Program

For most four-year schools, the classes here are for preparatory purposes only and the classes are accepted only as electives. You must complete a total of 18 units in Cinema. See the counseling office for more details.

REQUIRED CORE

Cinema 1	3
Cinema 2	3
Cinema 3	3
Cinema 4	3
Total Core Units	12

Plus two Cinema Electives for a total of 6 units from any of the courses listed below: Cinema 5, 6, 7, 9, 10, 20, 22, 25, 32, 33, 34, 35, 38, 60 and Television 1, 4, 9, 25. Courses may be substituted under special circumstances and with departmental approval.

To complete general education requirements in this area of study, Plan A for the AA/AS Degree is required.

PLAN A: Please consult with a counselor about specific courses needed or see the college catalog

"Graduation Requirements" section. Plan A is designed for transfer to a four-year college or university. However, requirements vary depending upon the individual institution. Please consult with a counselor for the specific requirements of the university you plan to attend.

3-6 Units	English Composition
6-9 Units	Communication/Analytical Thinking
3 Units	Natural Sciences
3 Units	Humanities
9 Units	Social/Behavioral Sciences (including American History & Governments)
3-4 Units	Health/Physical Education
3-5 Units	Math Competency

(Math 115 or higher or passing score on Los Angeles Community College District Math competency exam)

CINEMA PRODUCTION - "PLAN B"

Associate of Arts Degree Career Program

This curriculum in the Cinema-Television Department is designed for the student who wishes training in motion picture production. The course of study leads to an Associate of Arts degree in Cinema and/or a Cinema Production Certificate. An Associate of Arts degree with an emphasis in Cinema will be awarded to students who have completed a minimum of 36 units in Cinema and/or Television with a minimum of 31 units in Cinema. Supplies and books for production classes can vary from \$50-\$500 or more, depending upon the class and the scope of the student project.

All Cinema and Television courses must be completed with a satisfactory grade.

REQUIRED CORE

Cinema 1	3
Cinema 2	3
Cinema 3	3
Cinema 4	3
Subtotal - Core Units	12

Electives: Select additional courses from below to complete 24 additional units in the major.
(Prerequisites may apply and must be followed.)

Cinema 5, 6, 7, 9, 10, 20, 22, 25, 32, 33, 34, 35, 38, 60	3
Cinema 15	3
Cinema 911, 921 or 931	3
Law 33	3
Television 1, 4, 9, 25	3

To complete general education requirements in this area of study, Plan B for the AA/AS Degree is required.

PLAN B: Please consult with a counselor about specific courses needed or see the college catalog

"Graduation Requirements" section. Plan B is not designed for transfer to a four-year college.

3 Units	English Composition
3 Units	Communication/Analytical Thinking
3 Units	Natural Sciences
3 Units	Humanities
3 Units	Social/Behavioral Sciences (including American History & Governments)
3-4 Units	Health/Physical Education
3-5 Units	Math Competency

TELEVISION PRODUCTION

The Cinema-Television Department offers two Associate of Arts Degrees in Cinema. "Plan A" is for students planning to transfer to a four-year college or university. "Plan B" is a training program in television production.

The Television major in the Cinema-Television Department has been designed to provide the student with a solid background in studio television production and post-production. Television 1, 4, and 9 must be completed first.

TELEVISION PRODUCTION – "PLAN A"

Associate of Arts Degree Transfer Program

For most four-year schools, the classes here are for preparatory purposes only and the classes are accepted only as electives. You must complete a total of 18 units in Television or Cinema. See the counseling office for more details.

REQUIRED CORE

Television 1	3
Television 4	3
Television 9	3
Television 46	3
Total Core Units	12

Plus two Television electives for a total of 9 units from any of the courses listed below:

Television 6, 7, 25, 48, 49, 55, 60

Cinema 1, 2, 3, 4, 5, 6, 7, 9, 10, 20, 22, 25, 32, 34, 38, 60. Courses may be substituted under special circumstances and with departmental approval.

To complete general education requirements in this area of study, Plan A for the AA/AS Degree is required.

PLAN A: Please consult with a counselor about specific courses needed or see the college catalog

“Graduation Requirements” section. Plan A is designed for transfer to a four-year college or university. However, requirements vary depending upon the individual institution. Please consult with a counselor for the specific requirements of the university you plan to attend.

- 3-6 Units English Composition
 - 6-9 Units Communication/Analytical Thinking
 - 3 Units Natural Sciences
 - 3 Units Humanities
 - 9 Units Social/Behavioral Sciences (including American History & Governments)
 - 3-4 Units Health/Physical Education
 - 3-5 Units Math Competency
- (Math 115 or higher or passing score on Los Angeles Community College District Math competency exam)

TELEVISION PRODUCTION – “PLAN B”

**Associate of Arts Degree
Career Program**

An Associate of Arts degree with an emphasis in Television will be awarded to students who have completed a minimum of 36 units in Cinema and/or Television with a minimum of 21 units in Television. All courses must be taken at LACC and completed with a satisfactory grade.

REQUIRED CORE

Television 1.....	3
Television 4.....	3
Television 9.....	3
Television 46.....	3
Subtotal - Core Units.....	13

Electives: Select additional courses from below to complete 24 additional units in the major.

(Prerequisites may apply and must be followed.)

- Television 6, 7, 25, 48, 49, 55, 60..... 3
- Suggested Electives: Cinema 1, 2, 3, 4, 5, 6, 7, 9, 10, 15, 20, 22, 25, 32, 33, 34, 35, 38, 60; Television 911, 921, 931. (3 units maximum)

To complete general education requirements in this area of study, Plan B for the AA/AS Degree is required.

PLAN B: Please consult with a counselor about specific courses needed or see the college catalog “Graduation Requirements” section. Plan B is not designed for transfer to a four-year college.

- 3 Units English Composition
- 3 Units Communication/Analytical Thinking
- 3 Units Natural Sciences
- 3 Units Humanities
- 3 Units Social/Behavioral Sciences (including American History & Governments)
- 3-4 Units Health/Physical Education
- 3-5 Units Math Competency

CERTIFICATE PROGRAMS

CINEMA PRODUCTION

Certificate

A certificate in Cinema Production will be issued by the Cinema-Television Department upon submittal of an application by the student to the Department Chair after successful completion of the courses listed below. All courses must be taken at LACC and completed with a satisfactory grade.

Cinema 1.....	3
Cinema 2.....	3
Cinema 3.....	3
Cinema 4.....	3
Cinema 5.....	3
Cinema 6.....	3
Cinema 9.....	3
Cinema 10.....	3
Cinema 20.....	3
Cinema 32.....	3
Law 33 or Cinema 33.....	3
Total Units.....	33

CINEMA/VIDEO PRODUCTION

Certificate

A certificate in Cinema Production will be issued by the Cinema-Television Department upon submittal of an application by the student to the Department Chair and successful completion of the courses listed below. All courses must be taken at LACC and completed with a satisfactory grade.

Cinema 1.....	3
Cinema 2.....	3
Cinema 3.....	3
Cinema 4.....	3
Cinema 6.....	3
Cinema 9.....	3
Cinema 32.....	4
Television 4 or 9.....	3
Television 6 or 48.....	3
Television 46.....	3
Television 55 or TV 60.....	3
Total Units.....	33

TELEVISION PRODUCTION

Certificate

A certificate in Television Production will be issued by the Cinema-Television Department upon submittal of an application by the student to the Department Chair and successful completion the courses listed below and application to the Chairman. All courses must be taken at LACC and completed with a satisfactory grade.

Cinema 1.....	3
Cinema 2.....	3
Television 1.....	3
Television 4.....	3
Television 6 or 7 or other 3-unit Cinema/Television course.....	3
Television 9.....	3
Television 46.....	3
Television 48 or 49.....	3
Television 55.....	3
Television 60.....	3
Additional Cinema/TV class or Co-Op Education class.....	3
Total Units.....	33

BEGINNING FILM & TELEVISION PRODUCTION

Skill Certificate

A skills certificate in Beginning Film and Television Production will be issued by the Cinema-Television Department upon submittal of an application by the student to the Department Chair and successful completion of the courses listed. All courses must be taken at LACC and completed with a satisfactory grade.

Cinema 1	3
Cinema 2	3
Television 4	3
Television 9	3
Total Units	12

CINEMA POST-PRODUCTION

Skills Certificate

A skill certificate in Post-production will be issued by the Cinema-Television Department upon submittal of an application by the student to the Department Chair and successful completion of the courses listed. All courses must be taken at LACC and completed with a satisfactory grade.

Cinema 9	3
Cinema 22	3
Cinema 32	3
Cinema 35	3
Total Units	12

CINEMATOGRAPHY

Skills Certificate

A skill certificate in Cinematography will be issued by the Cinema-Television Department upon submittal of an application by the student to the Department Chair and successful completion of the courses listed. All courses must be taken at LACC and completed with a satisfactory grade.

Cinema 6	3
Cinema 7	3
Photography 7	3
Photography 10	3
Total Units	12

DIRECTING

Skills Certificate

A skill certificate in Directing will be issued by the Cinema-Television Department upon submittal of an application by the student to the Department Chair and successful completion of the courses listed. All courses must be taken at LACC and completed with a satisfactory grade.

Cinema 5 or Television 25	3
Cinema 10	3
Cinema 20	3
Theater Arts 200	3
Theater Arts 225	3
Total Units	15

PRODUCING

Skills Certificate

A skill certificate in Producing will be issued by the Cinema-Television Department upon submittal of an application by the student to the Department Chair and successful completion of the courses listed. All courses must be taken at LACC and completed with a satisfactory grade.

Cinema 5 or Television 25	3
Cinema 20	3
Cinema 25	3
Business 1	3
Law 33	3
Total Units	15

TELEVISION STUDIO PRODUCTION

Skills Certificate (Level I)

A skills certificate in Television Studio Production (Level I) will be issued by the Cinema-Television Department upon submittal of an application by the student to the Department Chair and successful completion of the courses listed. All courses must be taken at LACC and completed with a satisfactory grade.

Television 1	3
Television 4	3
Television 9	3
Television 46	3
Total Units	12

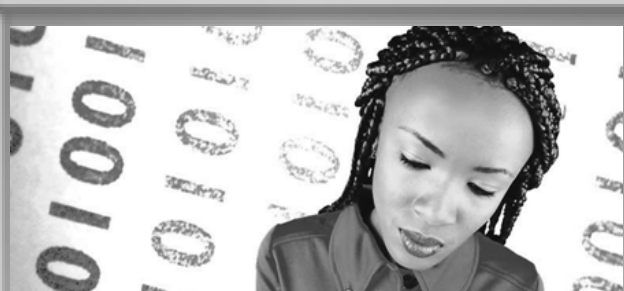

CSIT
 (Computer Science/
 Information Technology)

Chair: Roger Wolf
(323) 953-4000 ext.2680•AD321

www.lacitycollege.edu/academic/departments/math/csitdept/

PROGRAMS OFFERED

Associate of Science:
 Computer Science/Information Technology
 Computer Information Systems

Certificates:
 Applications Software
 Programming Languages

Skill Certificates:
 Computer Networking Database
 Administration
 Operating Systems
 UNIX Operating System
 Web Client Technologies
 Web Server Technologies

NOTE: The official abbreviation for Computer Science/Information Technology (CSIT) is "CO SCI". If you have a talent for math and science our programs will prepare you to enter more advanced university programs or directly enter careers related to Computer and Information Systems, System Analysis, Computer Science, Database Administration, Computer Operations, Information Processing Services, Computer Software Engineering, Telecommunications, and Web Development and Technologies. According to the Department of Labor median hourly earnings for high demand occupations in technology and other computer fields at the entry levels range from nearly \$12/hour to \$26/hour. With advance training and or a Bachelors degree, salaries can exceed \$42/ hour.

The Computer Science Information Technology discipline program at Los Angeles City College offers two Associate degrees that students can choose from depending on their career and educational goals. The first, Associate of Science in Computer Science, is designed for students with transfer goals to the Computer Science program at four-year universities. The second, an associate of science in Computer Information Systems, is designed to prepare students for careers in exciting Information Technology fields such as programming, software engineering, database administration, computer networking, multimedia, and web technologies. Students with interest in transferring to the Information Systems program at four-year universities should consult with the Computer Science department for needed course work. The following tables list the requirements for each degree. For information on general education courses, students are encouraged to see a counselor for advisement.

COMPUTER SCIENCE
Associate of Science Degree
Transfer Program

First Semester

CO SCI 104	3
CO SCI 107	3

(CO SCI 103 is a prerequisite to required CO SCI courses and can be used to fulfill a general education requirement)

Second Semester

CO SCI 134	3
CO SCI 139	3

Suggested Major Preparation:

Physics 1	4
Math 261	5

Third Semester

CO SCI 140 or 141	3
CO SCI 186	3

Suggested Major Preparation:

Philosophy 7, 8, or 9	3
-----------------------------	---

Fourth Semester

CO SCI 136	3
CO SCI 158	3
Total Major Units	24

Note: On approval by the Computer Science/Information Technology discipline, students may use Math 262, 263 and Physics 2, 3 as substitute to any of the CO SCI requirements except CO SCI 139, CO SCI 140 (or 141), and CO SCI 136 as long as a minimum of 18 CO SCI units is met.

To complete general education requirements in this area of study,

Plan A for the AA/AS Degree is required.

PLAN A: Please consult with a counselor about specific courses needed or see the college catalog "Graduation Requirements" section. Plan A is designed for transfer to a four-year college or university. However, requirements vary depending upon the individual institution. Please consult with a counselor for the specific requirements of the university you plan to attend.

ASSOCIATE DEGREE (Transfer Program)

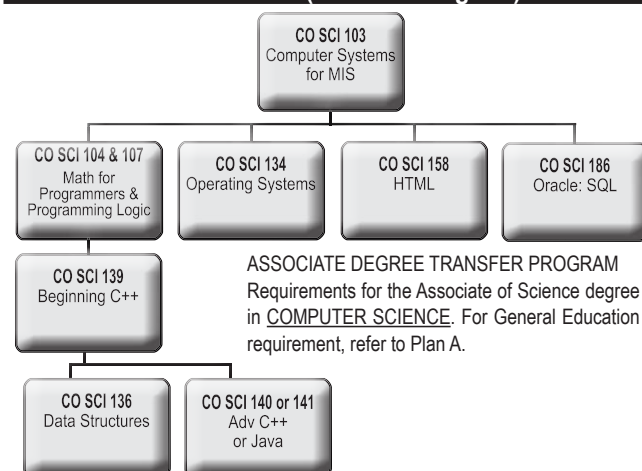

ASSOCIATE DEGREE TRANSFER PROGRAM Requirements for the Associate of Science degree in COMPUTER SCIENCE. For General Education requirement, refer to Plan A.

- 3-6 Units English Composition
 - 6-9 Units Communication/Analytical Thinking
 - 3 Units Natural Sciences
 - 3 Units Humanities
 - 9 Units Social/Behavioral Sciences (including American History & Governments)
 - 3-4 Units Health/Physical Education
 - 3-5 Units Math Competency
- (Math 115 or higher or passing score on Los Angeles Community College District Math competency exam)

COMPUTER INFORMATION SYSTEMS

Associate of Arts Degree
Career Program

First Semester

CO SCI 104	3
CO SCI 107	3

(CO SCI 103 is a prerequisite to required CO SCI courses and can be used to fulfill a general education requirement)

Second Semester

CO SCI 134	3
CO SCI 139 or 141	3
CO SCI 158	3
CO SCI 181	3

Third Semester

CO SCI 136	3
CO SCI 156	3
CO SCI 182	3
CO SCI 186	3

Fourth Semester

CO SCI 138, 140, or 142	3
CO SCI 187	3

Suggested Electives:

CO SCI 167	3
CO SCI 168	3

Total Major Units **36**

To complete general education requirements in this area of study, Plan B for the AA/AS Degree is required.

PLAN B: Please consult with a counselor about specific courses needed or see the college catalog

"Graduation Requirements" section. Plan B is not designed for transfer to a four-year college.

- 3 Units English Composition
- 3 Units Communication/Analytical Thinking
- 3 Units Natural Sciences
- 3 Units Humanities
- 3 Units Social/Behavioral Sciences (including American History & Governments)
- 3-4 Units Health/Physical Education
- 3-5 Units Math Competency

ASSOCIATE DEGREE (Career Program)

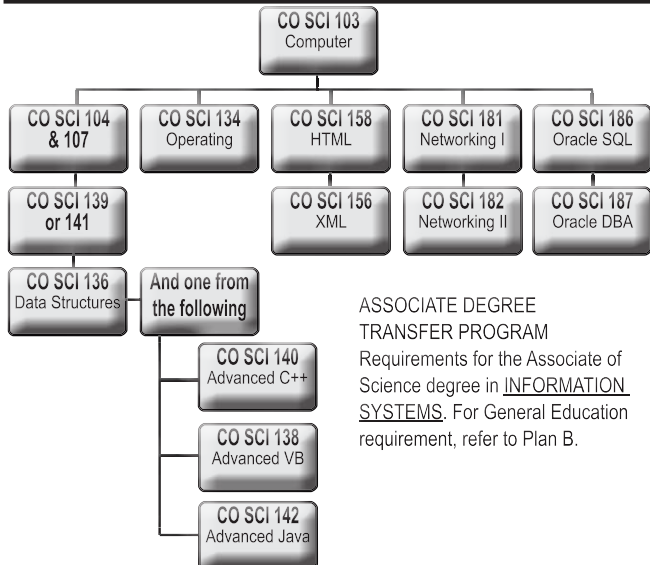

ASSOCIATE DEGREE TRANSFER PROGRAM
Requirements for the Associate of Science degree in INFORMATION SYSTEMS. For General Education requirement, refer to Plan B.

CERTIFICATE PROGRAMS

Certificates in Computer Science-Information technology will be issued by the Computer Science/Information Technology discipline upon submittal of an application to the department by the student and successful completion of one or more of the following sequences.

APPLICATIONS SOFTWARE Certificate

This sequence of courses prepares students for careers in applications software development and usage in fields related to databases, networking, web technologies, business analysis, and/or programming. Students successfully completing this program will find opportunities for employment in various industries depending on the track chosen for the electives.

CO SCI 103 or 101 and 108	4-7
CO SCI 104	3
CO SCI 107	3
CO SCI 134	3
CO SCI 138	3
CO SCI 148	3
CO SCI 186	3
Electives	6
Total Units.....	28-31

Acceptable Electives:

- Database Track: 2 courses from CO SCI 187, 188, 189, 198, and 199
- Networking Track: 2 courses from CO SCI 181, 182, and 183
- Operating Systems Track: 2 courses from CO SCI 167, 168, and 169
- Programming Track: 2 courses from CO SCI 136, 139, 140, 141, and 142
- Web Technologies Track: 2 courses from CO SCI 144, 155, 156, 158, and 159.

PROGRAMMING LANGUAGES Certificate

This course sequence provides students with comprehensive training in high- demand programming languages and tools such as Visual Basic, C++, Java, Perl, XML, ASP, and others. Students can choose electives from three exciting tracks: Databases, Web Development, and Operating Systems. Successful completion of the program will prepare students for an exciting career in software analysis, design, and development.

CO SCI 103 or 101 and 108	4-7
CO SCI 104	3
CO SCI 107	3
CO SCI 134	3
CO SCI 136	3
CO SCI 138	3
CO SCI 139 or 141	3
CO SCI 140 or 142	3
CO SCI 186	3
Electives	9
Total	37-40

Acceptable Electives: Databases Track: 3 courses – CO SCI 187, 188, 189, 198, and 199 Web Development Track: 3 courses from CO SCI 144, 155, 156, 158, and 159 Operating Systems Track: 3 courses – CO SCI 167, 168, and 169

COMPUTER NETWORKING

Skill Certificate

This course sequence offers state of the art hands-on training in designing, configuring, and maintaining basic networks using Cisco routers and switches. The program also prepares students for the Cisco Certified Networking Associate (CCNA) exam.

CO SCI 181	3
CO SCI 182	3
CO SCI 183	3
CO SCI 184	3
Total Units.....	12

DATABASE ADMINISTRATION

Skill Certificate

This course sequence offers state of the art hands-on training in setting up and administering Oracle relational databases and prepares students for the Oracle professional certification in database administration.

CO SCI 186	3
CO SCI 187	3
CO SCI 188	3
CO SCI 189	3
Total Units.....	12

DATABASE Developer

Skill Certificate

Use Oracle Developer Suite 10g and deploy applications on the Web with Oracle Application Server 10g. The students learn how to build forms and reports and use the web to access them. Students also learn the procedural language PL/SQL for Oracle.

CO SCI 186	3
CO SCI 198	3
CO SCI 199	3
Total Units.....	9

OPERATING SYSTEMS

Skill Certificate

This program provides hands-on training in the use of UNIX and WINDOWS operating systems and prepares students for Microsoft Certificate Professional (MCP) examination.

CO SCI 134	3
CO SCI 167	3
CO SCI 168	3
CO SCI 169	3
Total Units.....	12

Plus one of the elective options CO SCI 189 Oracle Perf. & Tuning or CO SCI 198 Oracle PL/SQL

UNIX OPERATING SYSTEMS

Skill Certificate

The UNIX operating system is very widely used in education, business, science, and industry both in servers and in desktop applications. Almost 70% of the Internet's World-Wide Web servers are driven by some version of UNIX or LINUX. UNIX is used in specialty desktop systems that require complex graphics or scientific processing. In servers, UNIX supports web services, database systems, advanced scientific computing, and vast communications networks. UNIX can be used in cluster systems requiring thousands of processors or in small embedded systems involved in simple robotic applications. It is the system of choice for the vast majority of university applications.

CO SCI 144.....	3
CO SCI 158.....	3
CO SCI 168.....	3
CO SCI 169.....	3
CO SCI 170.....	3
CO SCI 171.....	3
Total Units	18

WEB CLIENT TECHNOLOGIES

Skill Certificate

Program provides training in the use of client-side web technologies for design and development of interactive web sites. Skills include use of HTML, DHTML, XML, Java, Java Script, Dreamweaver and Flash in web site development.

CO SCI 141.....	3
CO SCI 151.....	3
CO SCI 152.....	3
CO SCI 156.....	3
CO SCI 158.....	3
Total Units	15

WEB SERVER TECHNOLOGIES

Skill Certificate

The Web Server Technologies program provides training in the use of server-side web technologies for the design and development of E-Commerce web sites. These include the use of CGI scripts, Active Server Pages, and Database Servers to create realistic e-commerce sites. Server-side concepts related to the Windows and Unix operating systems are covered. Students will also get introduction to the Oracle's database technology and how to develop dynamic, interactive and scalable database driven Web applications.

CO SCI 134.....	3
CO SCI 155.....	3
CO SCI 159.....	3
CO SCI 167 or 168.....	3
CO SCI 158.....	3
Total Units	15

APPLICATIONS SOFTWARE CERTIFICATE

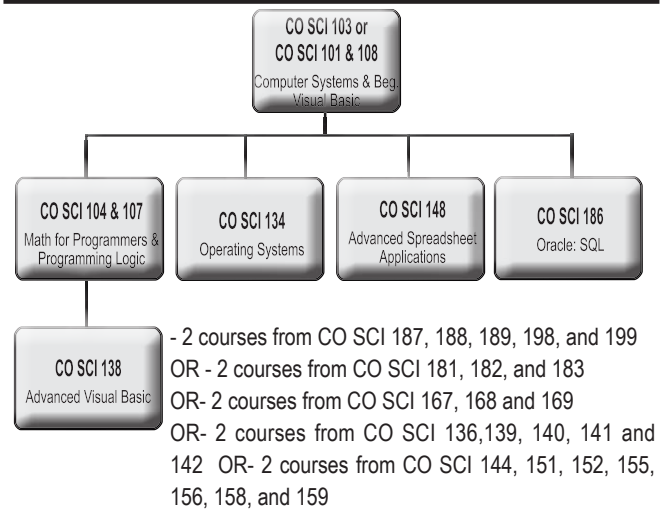

PROGRAMMING LANGUAGES CERTIFICATE

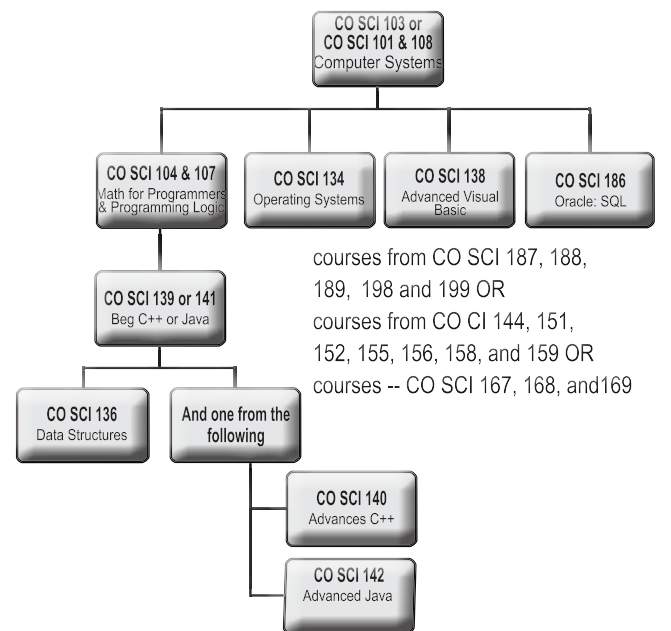

COMPUTER NETWORKING SKILL CERTIFICATE

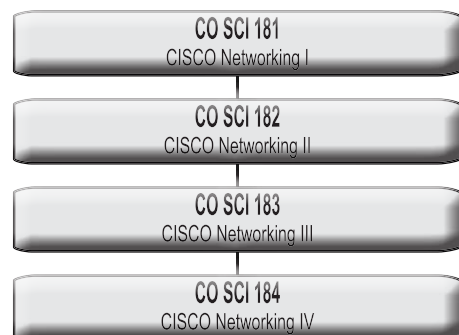

DATABASE ADMINISTRATION SKILL CERTIFICATE

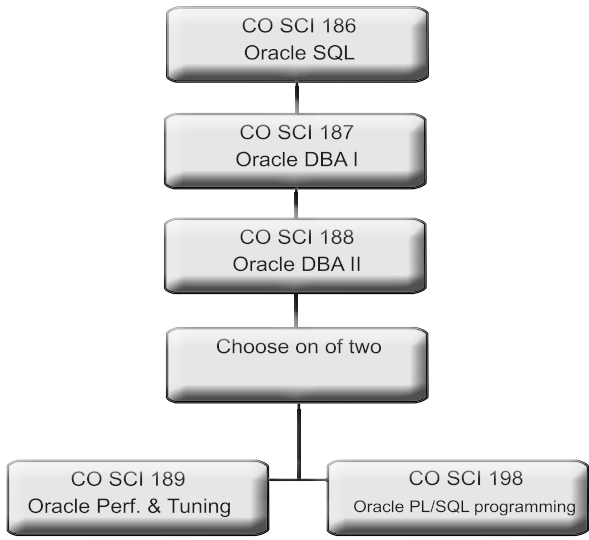

UNIX OPERATING SYSTEMS SKILL CERTIFICATE

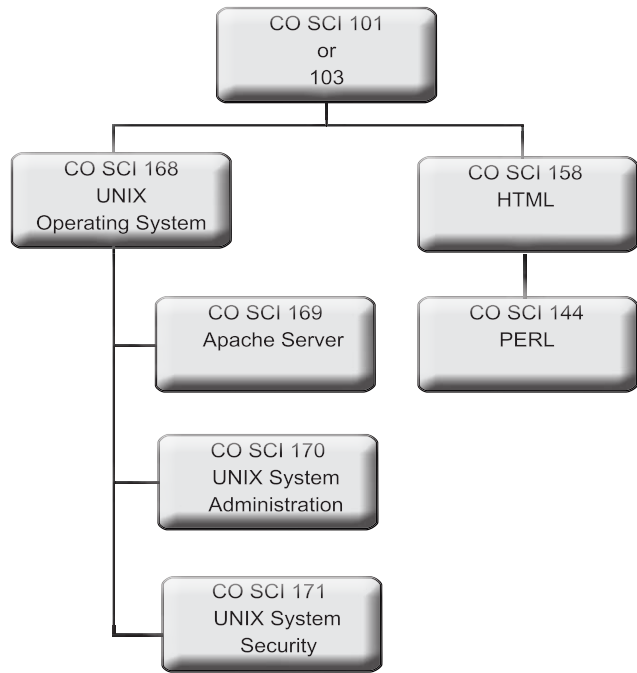

DATABASE DEVELOPER SKILL CERTIFICATE

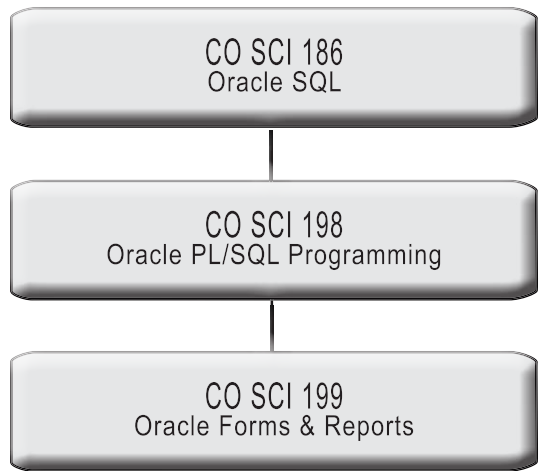

WEB CLIENT TECHNOLOGIES SKILL CERTIFICATE

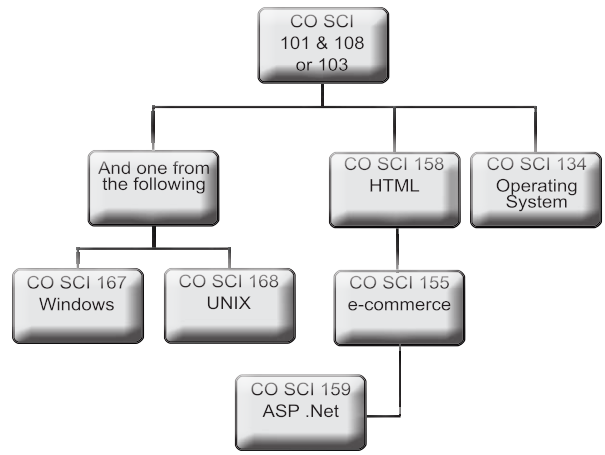

OPERATING SYSTEMS SKILL CERTIFICATE

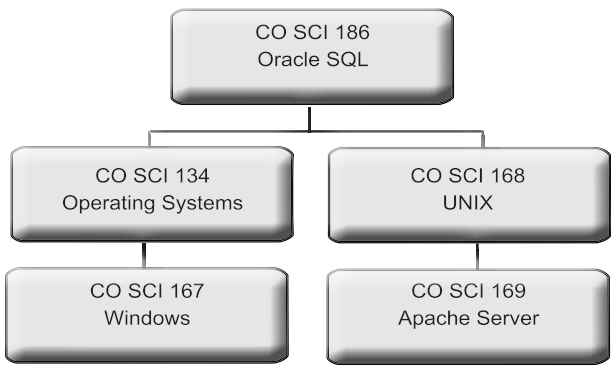

WEB SERVER TECHNOLOGIES SKILL CERTIFICATE

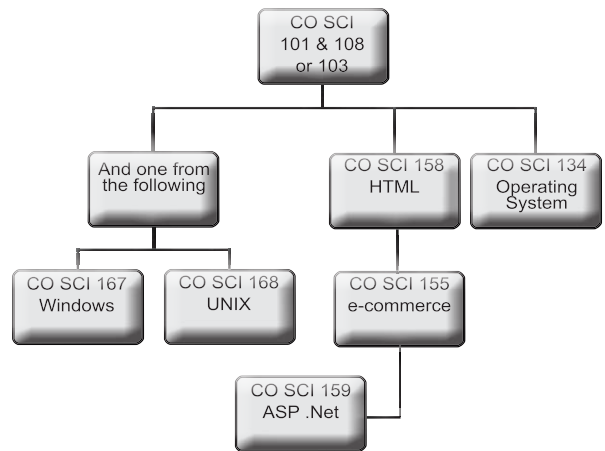



COMPUTER TECHNOLOGY

(323) 953-4000 ext. 2810 • JH312

www.lacitycollege.edu/academic/departments/ctel/index.html

PROGRAMS OFFERED Associate of Science: Computer Technology

Certificates:
 Computer Technology
 CompTIAA+ Certification
 CompTIA Network+ Certification

The computer technology curriculum has been developed to provide training in the principles underlying the design of modern computer systems. The program presents theory of computer architecture and design, operation of equipment, and diagnostic programming. Emphasis is placed on essential electronics, design of digital systems used in robotics, automation and industrial control, data processing, and networking. Practical aspects of maintenance, troubleshooting, and integration of digital and analog systems are included.

To complete general education requirements in this area of study, Plan B for the AA/AS Degree is required.

PLAN B: Please consult with a counselor about specific courses needed or see the college catalog "Graduation Requirements" section. Plan B is not designed for transfer to a four-year college.

- 3 Units English Composition
- 3 Units Communication/Analytical Thinking
- 3 Units Natural Sciences
- 3 Units Humanities
- 3 Units Social/Behavioral Sciences (including American History & Governments)
- 3-4 Units Health/Physical Education
- 3-5 Units Math Competency

DEGREE PROGRAM

COMPUTER TECHNOLOGY
 Associate of Science Degree
Career Program

COMPTIA CERTIFICATES

First Semester

Computer Technology 1	4
Electronics 2	3
Electronics 4	4
Electronics 10	3

Second Semester

Computer Technology 20.....	4
Electronics 6	4
Electronics 8	4
Electronics 12.....	3

Third Semester

Computer Technology 30.....	4
Computer Technology 36.....	4

Fourth Semester

Computer Technology 46.....	4
Computer Technology 48.....	4

Total Units 45

CERTIFICATE PROGRAMS

COMPUTER TECHNOLOGY

Certificate

A Computer Technology certificate will be issued by the Mathematics Department upon submittal of an application by the student to the department with the successful completion of the following courses. All students must receive a satisfactory grade or better to meet certificate requirements.

Computer Technology 1	4
Computer Technology 20.....	4
Computer Technology 30.....	4
Computer Technology 36.....	4
Computer Technology 46.....	4
Computer Technology 48.....	4
Electronics 2	3
Electronics 4	4
Electronics 6	4
Electronics 8	4
Electronics 10	3
Electronics 12.....	3

Total Units..... 45

PROGRAM IN CompTIA A+ CERTIFICATION Skills

Certificate

Los Angeles City College offers a program for preparation for the CompTIA A+ Computer Systems certificate, and industry standard certification for those who work with computer hardware and systems software. Upon completing this short program, the student is fully prepared to sit for the CompTIA A+ Certification Examination. The CompTIA A+ Examination itself is administered outside of Los Angeles City College. The Mathematics Department will issue a completion certificate upon application by the student with the successful completion of the following courses. Students must receive a satisfactory grade or better to meet certificate requirements.

Computer Technology 1	4
Computer Technology 12.....	4
Computer Technology 14.....	4
Electronics 2 or 4 or 6.....	3- 4
Total Units.....	15-16

PROGRAM IN CompTIA NETWORK+ CERTIFICATION Skills Certificate

Los Angeles City College offers a program for preparation for the CompTIA Network+ Certificate, the industry standard certification for those who install, configure, and operate local and wide area networks of computers. Upon completing this program, the student is fully prepared to sit for the CompTIA Network+ Certification Examination.

Computer Technology 1	4
Computer Technology 4	4
Computer Technology 15.....	4
Total Units.....	12



COOPERATIVE EDUCATION

**Chair: Devon Werble, Dir.
(323) 953-4000 ext. 2236 • AD 209**

**PROGRAMS OFFERED
Courses Only - No Degree/Certificate
See Below**

Through Cooperative Education or "CO-OP ED," students may earn college credit for their on-the-job work experience.

CO-OPED is designed to enhance the student's academic and personal development. Educational objectives are carefully planned and coordinated with the student's employer to provide realistic employment relationships.

To be eligible, students are expected to:

- Attend two (2) 2.5 hour seminars;
- Be enrolled in seven (7) or more units (which may include CO-OP ED units) at LACC during regular Spring and Fall semesters;
- Be currently employed and/or have arranged an internship through an employer; and
- Complete a CO-OP ED application and submit the CO-OP ED agreement, signed by the employer.

For students working in their major or a related field, a maximum of four (4) units may be earned per semester for a total of sixteen (16) units maximum in CO-OP ED. The same CO-OP ED course may be repeated for a maximum of four (4) semesters. Students may enroll in one (1) section number and a maximum of four (4) CO-OP ED units per semester.

LACC COOPERATIVE EDUCATION (CO-OP ED) COURSES Vocational Disciplines Offering Co-op Ed Experience
Note: Students in the following declared majors may enroll under the following disciplines: Business, Cinema, CAOT, Music, Television

Non-Vocational Disciplines Listed for Cooperative Education
Note: In accordance with the State Chancellors' guidelines, students may enroll in general Co-op Ed courses under the state approved top code.



DENTAL TECHNOLOGY

**Chair: Dana Cohen
(323) 953-4000 ext. 2502 • SCI 325**
<http://dental.lacitycollege.edu>

**PROGRAMS OFFERED
Associate of Science:
Dental Technology**

**Certificate
Dental Technology**

Dental Technology (often referred to as Dental Laboratory Technology) is a career in the design and manufacturing of dental prosthetic devices (dentures, partial dentures, crowns and bridges) and orthodontic devices (both passive and active retainers). Dental Technicians and technologists usually work in a commercial dental laboratory which is separate from the dental practice. Salary is based upon knowledge level, experience and speed of manufacture among other aspects. Dental technicians receive dental impressions and prescriptions (work authorizations) from the dentist, apply their expertise and return the prescribed appliance to the dentist for placement in the patient's mouth.

DEGREE PROGRAM

**DENTAL TECHNOLOGY
Associate of Science Degree
Career Program**

This curriculum is specifically designed to provide students with the skills, knowledge and background necessary to become a dental technician in either a commercial dental laboratory or dental office laboratory. Good eye/hand

coordination, communication skills and the ability to follow directions are requisites for successful entrance into this program. Students selected for each new group are admitted into the program based upon their successful completion of DT 100 course; their dexterity exam score administered during the DT 100 course; evaluation of the student's level of commitment and determination and the ability to follow directions. All candidates for the Dental Technology program must have a high school diploma or G.E.D.

Courses in the Dental Technology curriculum are designed to be taken in sequence. Successful completion of each Dental Technology course in a particular sequence with a grade of "C" or better is required before the student may progress into the next level of courses in the sequence. All courses listed are required for the Associate of Science degree with a major in Dental Technology. Students who successfully complete all the Dental Technology courses will be eligible to sit for the Recognized Graduate Certified Dental Technician Exam given by the National Board for Certification of Dental Technicians.

Note: Math 112 Pre-Algebra or higher must be taken before completion of the Dental Technology Program.

PREREQUISITE

Dental Technology 100 2
 (See Graduation Requirements "Plan B") 3

First Semester

Dental Technology 101 2
 Dental Technology 102 3
 Dental Technology 103 5
 Dental Technology 109 4
 (See Graduation Requirements "Plan B") 3

Intersession

Dental Technology 106 3

Second Semester

Dental Technology 105 2
 Dental Technology 108 3
 Dental Technology 111 5
 Dental Technology 112 3
 (See Graduation Requirements "Plan B") 3

Intersession

Dental Technology 203 2

Third Semester

Dental Technology 204 3
 Dental Technology 205 or 206 10
 (See Graduation Requirements "Plan B") 3

Intersession

Dental Technology 203 2

Fourth Semester

Dental Technology 207 or 208 10
 Dental Technology 202 2
 (See Graduation Requirements "Plan B") 3

Total Units 77

To complete general education requirements in this area of study, Plan B for the AA/AS Degree is required.

PLAN B: Please consult with a counselor about specific courses needed or see the college catalog "Graduation Requirements" section. Plan B is not designed for transfer to a four-year college.

- 3 Units English Composition
- 3 Units Communication/Analytical Thinking
- 3 Units Natural Sciences

- 3 Units Humanities
- 3 Units Social/Behavioral Sciences (including American History & Governments)
- 3-4 Units Health/Physical Education
- 3-5 Units Math Competency

CERTIFICATE PROGRAM

DENTAL TECHNOLOGY

Certificate

This curriculum is specifically designed to provide students with the skills, knowledge and background necessary to become a dental technician in either a commercial dental laboratory or dental office laboratory. Good eye/hand coordination, communication skills and the ability to follow directions are requisites for successful entrance into this program. Students selected for each new group are admitted into the program based upon their successful completion of DT 100 course; their dexterity exam score administered during the DT 100 course; evaluation of the student's level of commitment and determination and the ability to follow directions. All candidates for the Dental Technology Program must have a high school diploma or G.E.D.

Courses in the Dental Technology curriculum are designed to be taken in sequence. Successful completion of each Dental Technology course in a particular sequence with a grade of "C" or better is required before the student may progress into the next level of courses in the sequence. All courses listed are required for the Associate of Science degree with a major in Dental Technology. Students who successfully complete all the Dental Technology courses will be eligible to sit for the Recognized Graduate Certified Dental Technician Exam given by the National Board for Certification of Dental Technicians.

A certificate in Dental Technology will be issued by the Dental Technology Department upon successful completion of all Dental Technology courses. Courses in the Dental Technology Certificate program are the following: Note: Math 112 Pre-Algebra or higher must be taken before completion of the Dental Technology Program.

PREREQUISITE

Dental Technology 100 2

First Semester

Dental Technology 101 2
 Dental Technology 102 3
 Dental Technology 103 5
 Dental Technology 109 4

Intersession

Dental Technology 106 3

Second Semester

Dental Technology 105 2
 Dental Technology 108 3
 Dental Technology 111 5
 Dental Technology 112 3

Intersession

Dental Technology 203 2

Third Semester

Dental Technology 204 3
 Dental Technology 205 OR 206 10

Fourth Semester

Dental Technology 207 or 208.....10
 Dental Technology 202 2

Total Units.....58

**MASTER CERAMIST
 Certificate**

The Master Ceramist Program offered by LACC at UCLA dental school is a unique program that trains dental technicians in the art and science of esthetic dental restorations. Successful completion of the Dental Technology Associate or Certificate Program is the prerequisite for selection into the UCLA Master Ceramist Program. The Master Ceramist Program requires the candidate to take a prerequisite course DT 300. The selection of each group is based upon the student's progress during this course and an oral interview conducted by the course instructor and the director of the UCLA program. The Program consists of courses in the arts and sciences of esthetic dental restorations.

A certificate will be issued by UCLA Center for Esthetic Dental Design upon completion of the following courses:

PREREQUISITE

DT 3000.5

First Semester

DT 3013.5
 DT 3021
 DT 3034
 DT 3044
 DT 3054

Intersession

DT 3063
 DT 3072

Second Semester

DT 30914
 DT 31011

Intersession

DT 3084

Third Semester

DT 3013.5
 DT 3021
 DT 3034
 DT 3044
 DT 3054

Intersession

DT 3063
 DT 3072

Fourth Semester

DT 30914
 DT 31011

Intersession

DT 3084

All courses are repeated in the second year.

**ADVANCED PROSTHODONTIC, IMPLANT AND MAXILLOFACIAL
 Certificate**

The Advanced Prosthodontic, Implant and Maxillofacial Program is a unique program that trains dental technicians in the art and science of Advanced Prosthodontic Devices, Dental Implant Technology and the delicate art of making prosthetic replacements for the human face and head. Successful completion of the Dental Technology Associate or Certificate Program is the prerequisite for selection into the Advanced Prosthodontic, Implant and Maxillofacial Program. The Advanced Prosthodontic, Implant and Maxillofacial Program, requires that the candidate spend a week shadowing a current student followed by an oral interview conducted by the UCLA program director and faculty. The program consists of the art science and technology of implant restorations, full mouth reconstructions and replacement parts of the human face.

A certificate will be issued by UCLA Advanced Prosthodontic Department upon completion of the following courses:

Intersession

DT 4015

First Semester

DT 40214

Intersession

DT 4035

Second Semester

DT 40414

The Advanced Prosthodontic Program may offer the student the opportunity to complete another year of training in even more advanced techniques. In this case the student repeats the above sequence a second time.

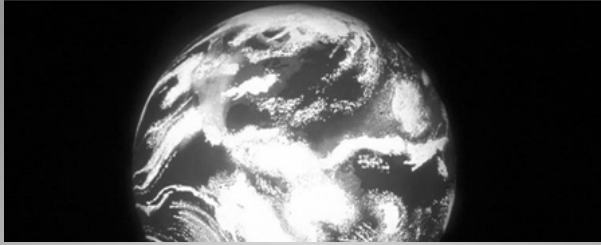

EARTH SCIENCES

Chair: John Freitas
(323) 953-4000 EXT. 2600 • SCI 324B

Vice Chair: Christie O'Boyle
(323) 953-4000 EXT. 2691 • SCI 324

Department of Chemistry and Earth Sciences

www.lacitycollege.edu/academic/department/chemistry/chemweb

PROGRAMS OFFERED

Courses Only - No Degree/Certificate
Earth Science
Geography
Geology
Meteorology
Oceanography



ELECTRONICS

Chair: Roger Wolf
(323) 953-4000 ext. 2810 • JH 312
www.lacitycollege.edu/academic/departments/ctel/index.html

PROGRAMS OFFERED

Associate of Science:
Electronic Systems Technology

Certificate

Basic Electronics
Electronic Systems Technology
Electronics Technology (Fast Track Program)

If you are interested in how things work, our Electronics programs will prepare you for entry-level positions related to computer hardware and electronics. Opportunities include: computer repair, manufacture, installation and design; manufacturing and/or repairing electronic equipment including transmission devices used by electronic utilities; machinery controls; telecommunications; wiring in buildings, automobiles, aircraft, robotics, printed circuit development; and more. Students completing one of the certificate programs can expect to enter high paying positions in the computer/electronics industries. With more experience and/ or a Bachelor's degree or advance trade certification (e.g. Electricians), entry-level technicians can advance in position and salary.

Our strength is our instructors and hands-on training. With years of realworld experience, our instructors bring quality instruction into the classroom that cannot be found in textbooks. Our smaller class size allows our instructors to give extra attention to the individual needs of each student. And, hands-on experience gives students the skills and confidence to be successful in the workforce.

DEGREE PROGRAM

ELECTRONIC SYSTEMS TECHNOLOGY

Associate in Science Degree

Career Program

This curriculum provides for the study of the technical aspects of applied electronics and is designed for persons seeking employment as an electronic technician, electronic service technician, communications technician, customer engineer, radiologic electronics specialist, electronic test technician, electronic research and development technician, or electronics equipment representative.

Successful completion of this curriculum will equip the graduate with sufficient mathematics and theory to enter employment and achieve advancement in a variety of job titles. Laboratory and practical courses develop skills that are immediately useful to prospective employers and, as well, provide a foundation for more advanced skills which can be developed with a minimum of on-the-job training.

First Semester

Computer Technology 1	4
Electronics 2	3
Electronics 4*	4
Electronics 10*	3

Second Semester

Electronics 6*	4
Electronics 8	4
Electronics 12*	3
Computer Technology 20	4

Third Semester

Electronics 20	4
Electronics 22	4

Fourth Semester

Electronics 24	4
Electronics 48	4
Total Units	45

* All majors are expected to take Electronics 4 and 10 during one semester. Students are urged to obtain assistance from department faculty in planning their programs.

Suggested Electives: Computer Technology 36, Physics 11

To complete general education requirements in this area of study, Plan B for the AA/AS Degree is required.

PLAN B: Please consult with a counselor about specific courses needed or see the college catalog "Graduation Requirements" section. Plan B is not designed for transfer to a four-year college.

- 3 Units English Composition
- 3 Units Communication/Analytical Thinking
- 3 Units Natural Sciences
- 3 Units Humanities
- 3 Units Social/Behavioral Sciences (including American History & Governments)
- 3-4 Units Health/Physical Education
- 3-5 Units Math Competency

ELECTRONICS TECHNOLOGY (Fast Track Program)

Associate in Science Degree

Career Program

The fast track electronics program combines the best and most important aspects of our traditional Electronics and Computer Technology Programs into a seamless sequence of classes. The essential theory of electronic devices and circuits are included, along with the theory and operation of digital circuits and microprocessor-based systems. Skills learned include the use of test equipment, circuit design and stimulation, assembly and test of electronic circuits, and troubleshooting. We make extensive use of the latest circuit design and stimulation software to assist you in visualizing and understanding how circuit work and how they are used in everyday systems like personal computers, cell phones, DVD and television systems, etc.

After successful completion of this program the graduate can enter the industry in a wide variety of entry level positions involved in electronic and computer fields (such as home/commercial security, computer manufacturing, digital communications, entertainment technology, and computer system networking), or transfer to California State University Los Angeles for a bachelor's degree in technology, engineering, or computer science.

First Semester

- Computer Technology 14
- Electronics 1515
- Electronics 1524

Second Semester

- Electronics 1536
- Electronics 1546

Third Semester

- Electronics 1554
- Electronics 1564
- Electronics 811
- Electronics 821
- Electronics 871
- Electronics 952
- Total Units**.....**38**

CERTIFICATE PROGRAMS

BASIC ELECTRONICS

Certificate

A certificate in Basic Electronics will be issued by the Mathematics Department upon submittal of an application by the student to the department and the successful completion of the following courses. All students must receive a satisfactory grade or better to meet certificate requirements.

- Computer Technology 14
- Computer Technology 124
- Computer Technology 204
- Electronics 44
- Electronics 64
- Electronics 84
- Electronics 103
- Electronics 123
- Total Units**.....**30**

Recommended Electives: Electronics 81, 83, and 87

ELECTRONIC SYSTEMS TECHNOLOGY

Certificate

A certificate in Electronic System Technology will be issued by the Mathematics Department upon submittal of an application by the student to the department and the successful completion of the following courses.

All students must receive a satisfactory grade or better to meet certificate requirements.

- Computer Technology 14
- Computer Technology 204
- Electronics 23
- Electronics 44
- Electronics 64
- Electronics 84
- Electronics 103
- Electronics 123
- Electronics 204
- Electronics 224
- Electronics 244
- Electronics 484
- Total Units**.....**45**

ELECTRONICS TECHNOLOGY (Fast Track Program)

Certificate

A certificate in Electronics Technology (Fast Track Program) will be issued by the Mathematics Department upon submittal of an application by the student to the department and the successful completion of the following courses.

All students must receive a satisfactory grade or better to meet certificate requirements.

- Computer Technology 14
- Electronics 1515
- Electronics 1524
- Electronics 1536
- Electronics 1546
- Electronics 1554
- Electronics 1564
- Electronics 811
- Electronics 821
- Electronics 871
- Electronics 952
- Total Units**.....**38**



ENGINEERING

Chair: Dr. Jayesh Bhakta
(323) 953-4000 ext. 2923 • SCI
222D

www.lacitycollege.edu/academic/departments/physics/

PROGRAMS OFFERED
Associate of Science: Engineering

The art and science of engineering bridges the gap between ideas and their realization. Meeting an engineering challenge requires technical expertise, skill in organizing and leading people, sound financial management, ability to handle legal issues, and the character to maintain high ethical standards. Hence an education in engineering provides one with a powerful mixture of technical expertise, creativity, people skills, and knowledge of real-world business issues. Such a set of skills is in high demand in the modern economy and are transferable.

LACC offers a full range of math, physics, and engineering courses for you to gain an associate degree or to allow you to meet your lower division requirements for transfer. In addition to courses, we offer an advisor program where you can be assigned a faculty member who will assist you with matters that relate to your academic progress. We also have an engineering club that allows students to gain experience in working on a team on an engineering project.

DEGREE PROGRAM

ENGINEERING

Associate of Science Degree

Transfer Program

The following classes are required to earn an Associate of Science degree in Engineering from Los Angeles City College. In addition to earning an A.S. degree, taking these courses will prepare the student for transfer to a four year college or university to pursue further studies in the engineering field.

For Electrical Engineering Majors or Computer Engineering Majors:	
General Engineering 101	2
Math 261 (First semester Calculus).....	5
Physics 101	5
Chemistry 101.....	5
General Engineering 131	3
Math 262.....	5
Physics 102	5
Math 263.....	5
Physics 103	5
Electrical Engineering 220.....	4
Math 275.....	3
Total Units.....	47

For Mechanical Engineering Majors or Civil Engineering Majors:	
General Engineering 101.....	2
Math 261	5
Physics 101	5
Chemistry 101.....	5
General Engineering 131.....	3
Math 262.....	5
Physics 102	5
CSIT 139 or 140	3
General Engineering 151.....	3
Math 263	5
Physics 103	5
General Engineering 241.....	3
Math 275	3
Electrical Engineering 220.....	4
Total Units.....	56

To complete general education requirements in this area of study, Plan A for the AA/AS Degree is required.

PLAN A: Please consult with a counselor about specific courses needed or see the college catalog "Graduation Requirements" section. Plan A is designed for transfer to a four-year college or university. However, requirements vary depending upon the individual institution. Please consult with a counselor for the specific requirements of the university you plan to attend.

- 3-6 Units English Composition
- 6-9 Units Communication/Analytical Thinking
- 3 Units Natural Sciences
- 3 Units Humanities
- 9 Units Social/Behavioral Sciences (including American History & Governments)
- 3-4 Units Health/Physical Education
- 3-5 Units Math Competency

(Math 115 or higher or passing score on Los Angeles Community College District Math competency exam)



ENGLISH & ESL

CHAIR: DR. TAMMY ROBINSON
(323) 953-4000 ext. 2700 •
JH300A

<http://www.lacitycollege.edu/academic/departments/eng/esl/index.html>

PROGRAMS OFFERED

Associate of Arts:
English
Other Courses:
Linguistics

The department offers extensive English and ESL courses. The courses are offered from basic skills English courses, ESL courses, and they extend to our transfer level. The English program is geared to assist students at all levels, so that they may improve their writing and prepare to transfer in an environment that fosters a rich literary tradition. Students develop methods for critical interpretations of relevant works of English, American, and other literatures in English. Our ESL programs offer courses to assist students to improve their ability to write, read, and listen/speak English..

DEGREE PROGRAM

ENGLISH

Associate of Arts Degree

Transfer Program

An Associate of Arts Degree in English requires a minimum of 18 units in the major in addition to the Plan A General Education requirements. The English curriculum encourages students who plan to transfer to begin their program of coursework early so that they will have completed all the required lower-division courses by the time they are ready to apply to four-year colleges or universities. In order to satisfy the requirements, 9 to 12 of the required 18 units must be satisfied by taking English 102 (if not used to fulfill general education requirements), 203, 205, and 206.

Students who transfer as English majors must realize that the requirements vary from institution to institution.

The requirements for additional English and foreign language classes vary from school to school. Students should consult with a counselor to make sure they have the most complete and up-to-date information. Please refer to www.assist.org for most recent major preparation requirements of CSU and UC systems

REQUIRED

English 102	3
English 203	3
English 205	3
English 206	3
Total Required Units	9-12

In addition to the courses listed above, students will fulfill the balance (6-9 units) of their required 18 units for their Associate of Arts Degree in English from the following courses:

ADDITIONAL

English 127	3
English 204	3
English 208	3
English 211	3
English 212	3
English 214	3
English 215	3
English 216	3
English 218	3
English 239	3
English 240	3
English 252	3
English 253	3
English 255	3
English 270	3
Total Additional Units	6-9

Total Units Required for the Associate of Arts Degree in English 18
(if Foreign Language Level III is chosen 20)

Note: English majors are also advised to take English 103 to fulfill a general education

requirement, but this course would not apply toward major requirements. Students who transfer as English majors must realize that requirements for additional English and foreign language classes vary from school to school. Students should consult with a counselor to make sure they have the most complete and up-to-date information.

To complete general education requirements in this area of study, Plan A for the AA/AS Degree is required.

PLANA: Please consult with a counselor about specific courses needed or see the college catalog "Graduation Requirements" section. Plan A is designed for transfer to a four-year college or university. However, requirements vary depending upon the individual institution. Please consult with a counselor for the specific requirements of the university you plan to attend.

- 3-6 Units English Composition
- 6-9 Units Communication/Analytical Thinking
- 3 Units Natural Sciences
- 3 Units Humanities
- 9 Units Social/Behavioral Sciences (including American History & Governments)
- 3-4 Units Health/Physical Education
- 3-5 Units Math Competency

(Math 115 or higher or passing score on Los Angeles Community College District Math competency exam)



FAMILY & CONSUMER STUDIES (DIETETICS)

Chair: Kathleen Bimber
(323) 953-4000 ext. 2290 •
AD 200

Vice Chair: Janice Young
(323) 953-4000 ext. 2291 •
AD 200

www.lacitycollege.edu/academic/departments/dietetics/index.html

PROGRAMS OFFERED

Associate of Science:
 Dietetic Technician
 (2 & 3 year plans)

Certificates:
 Dietetic Service Supervisor

The Family & Consumer Studies Department offers two career paths for students interested in a career in institutional food service and nutritional care of clients. Students may obtain a Dietetic Technician Associate of Science degree and/or a Dietetic Service Supervisor certificate.

When you complete an accredited certificate program in dietetics at LACC, you will be skilled in food preparation, nutrition, food service management, food sanitation and food safety.

The American Dietetic Association reports that demand continues to increase steadily for dietetic professionals as our population ages and society places more emphasis on nutrition. Full-time dietetic technicians earn between \$26,000 - \$37,000 per year on average and are employed by hospitals, skilled nursing facilities, schools, public health programs, health clubs and food companies – any place where the nutritional and safe preparation of large volumes of food is required.

Career opportunities include: Food preparation, management of food production and/or nutritional counseling for: Hospitals, HMOs, Clinics, Nursing Homes and Research Facilities; WIC, Meals on Wheels and other Public Programs; Schools & Day-Care Centers; Correctional Facilities; Restaurants; Food Companies & Distribution Operations; and Health Clubs & Weight Management Centers.

DEGREE PROGRAMS

DIETETIC TECHNICIAN

Associate of Science Degree

Career Program

Students transferring to a Dietetics program at a four year university should meet with a counselor.

SPECIAL NOTE:

During the July 23-24, 2001 meeting, the Dietetic Technician Program at Los Angeles City College was accredited by the Commission on Accreditation for Dietetics Education (CADE) of The American Dietetic Association. The address and phone number of CADE is 120 South Riverside Plaza, Suite 2000, Chicago, IL, 60606-6995, (312) 899-0040, extension 5500, www.eatright.org.

Dietetic Technicians, Registered (DTRs) are trained in food and nutrition and are an integral part of health care and food service management teams.

Dietetic Technicians, Registered work independently or in teams with Registered Dietitians in a variety of employment settings including health care, business and industry, community/public health, public health, food service, and research.

DTRs work in:

- Hospitals, HMOs, clinics, nursing homes, retirement centers, hospices, home health care programs, and research facilities, helping to treat and prevent disease and administering medical nutrition therapy as an important part of health care teams.
- Schools, day care centers, correctional facilities, restaurants, health care facilities, corporations, and hospitals, managing employees, purchasing, and food preparation and preparing budgets within food service operations.
- WIC programs, community/public health agencies, Meals on Wheels, and community health programs, developing and teaching nutrition classes for the public.
- Health clubs, weight management clinics, and community wellness centers, helping to educate clients about the connection between food, fitness, and health.

- Food companies, contract food management companies, or food vending and distributing operations, developing menus, overseeing food service sanitation and food safety, and preparing food labeling information and nutrient analysis.

Educational & Professional Requirements

- Courses are planned in sequence. Completion of all courses with at least a “C” grade is required for progress in the program.
- The Associate of Science degree curriculum meets the requirements of CADE of the American Dietetic Association.
- Refer to Graduation Requirements “Plan B” for additional information. Students wanting to transfer to a four-year college or university with a major in Dietetics or Nutrition should complete eighteen units in preparation for the major along with the General Education courses needed for transfer to the institution of their choice. The Associate of Arts degree should be in Liberal Studies. Consult with the four year college you will attend to find out the prerequisites that must be completed before applying to a Dietetics program.
- Class scheduling restricts the completion of this program to the day. However, working students who are able to have one to two day(s) off during the week may complete the program. Students must provide their own transportation to assigned supervised practice sites within the greater Los Angeles area. A Mantoux test, MMR, health exam and liability insurance are required for supervised practice courses. Some sites may require a background check.
- A verification statement that allows the candidate to sit for the Dietetic Technician Registration exam is issued upon successful completion of the program, submission of a notebook documenting how the 31 DT competencies have been met and a score of at least 75% on a preparation for the DTR exam administered by the Family and Consumer Studies Department. Students are eligible for membership in the American Dietetic Association. Passing the DTR exam authorizes use of the initials “DTR” after the name. Graduates may also take the Dietary Manager Managers Exam.
- DTR’s must complete professional educational requirements to maintain registration.

SUGGESTED 2-YEAR COURSE PLAN

(For Full-Time Students)

First Semester

Family & Consumer Studies 21 (Same as Nutrition 21).....	3
Family & Consumer Studies 50	3
Family & Consumer Studies 55	3
Math 115.....	5
English 101.....	3

Second Semester

Family & Consumer Studies 24	3
Family & Consumer Studies 56	3
Family & Consumer Studies 156	2
Speech Communication 101	3
Biology 25	3
Physical Education.....	1

Third Semester

Family & Consumer Studies 27	3
Family & Consumer Studies 51	3
Family & Consumer Studies 127	2
Family & Consumer Studies 151	2
Health 11.....	3
Humanities Requirement	3

Fourth Semester

Family & Consumer Studies 28 3
 Family & Consumer Studies 29 1
 Family & Consumer Studies 52 3
 Family & Consumer Studies 128 2
 Family & Consumer Studies 129 2
 American Institutions Requirement.....3
Total Units.....62

To complete general education requirements in this area of study, Plan B for the AA/AS Degree is required.
 PLAN B: Please consult with a counselor about specific courses needed or see the college

catalog "Graduation Requirements" section. Plan B is not designed for transfer to a four-year college.

- 3 Units English Composition
- 3 Units Communication/Analytical Thinking
- 3 Units Natural Sciences
- 3 Units Humanities
- 3 Units Social/Behavioral Sciences (including American History & Governments)
- 3-4 Units Health/Physical Education
- 3-5 Units Math Competency

**SUGGESTED 3-YEAR COURSE PLAN
 (For Part-Time Students)**

First Semester

Family & Consumer Studies 503
 Family & Consumer Studies 55..... 3
 Mathematics 115.....5
 English 101.....3

Second Semester

Family & Consumer Studies 21 (Same as Nutrition 21).....3
 Family & Consumer Studies 56..... 3
 Family & Consumer Studies 156 2
 Biology 25.....3

Third Semester

Family & Consumer Studies 27..... 3
 Family & Consumer Studies 127 2

Speech Communication 1013
 Physical Ed.....1

Fourth Semester

Family & Consumer Studies 24..... 3
 Family & Consumer Studies 28..... 3
 Family & Consumer Studies 128 2
 Health 11.....3

Fifth Semester

Family & Consumer Studies 51..... 3
 Family & Consumer Studies 151 2
 Humanities Requirement..... 3

Sixth Semester

Family & Consumer Studies 29..... 1
 Family & Consumer Studies 52..... 3
 Family & Consumer Studies 129 2
 American Institutions Requirement.....3
Total Units.....62

To complete general education requirements in this area of study, Plan B for the AA/AS Degree is required.
 PLAN B: Please consult with a counselor about specific courses needed or see the college

catalog "Graduation Requirements" section. Plan B is not designed for transfer to a four-year college.

- 3 Units English Composition
- 3 Units Communication/Analytical Thinking
- 3 Units Natural Sciences
- 3 Units Humanities
- 3 Units Social/Behavioral Sciences (including American History & Governments)
- 3-4 Units Health/Physical Education
- 3-5 Units Math Competency

CERTIFICATE PROGRAMS

DIETETIC SERVICE SUPERVISOR

Certificate

Completion of the Dietetic Service Supervisor Certificate program meets the standards of training for Dietetic Service Supervisors specified by the Department of Health Services. Completion of this certificate qualifies students to work as the food service director in a skilled nursing facility. Some responsibilities of the Dietetic Service Supervisor are to supervise employees, assure menu acceptance by clients, and manage food production. Completion of the program qualifies a person to take the Dietary Managers Exam.

Successful completion of English 28 is strongly advised for the DSS Certificate. Concurrent enrollment, or completion of Math 105, or Learning Skills 10ABC is advised to ensure successful completion of many courses in this certificate. A grade of "C" or better is required in all courses. Students must provide their own transportation to assigned field placement sites. A Mantoux test, health exam and liability insurance are required for supervised practice courses. Some sites may require a background check.

First Semester

Family & Consumer Studies 21 (Same as Nutrition 21)..... 3
 Family & Consumer Studies 50 3
 Family & Consumer Studies 51 3
 Family & Consumer Studies 55 3
 Family & Consumer Studies 151 2
 English 28 (strongly advised)



Second Semester

Family & Consumer Studies 24	3
Family & Consumer Studies 52	3
Family & Consumer Studies 56	3
Family & Consumer Studies 156	2
Mathematics 105 or Learning Skills 10ABC (strongly advised)	
Total Units	25



FOREIGN LANGUAGES

Chair: Eiko Kitajima Chatel
(323) 953-4000 ext. 2737
DH312B
www.lacitycollege.edu/academic/departments/forlang/index.html

PROGRAMS OFFERED

Associate of Arts:

- Chinese
- French
- Italian (Currently not offered)
- Japanese
- Korean
- Spanish

Other Courses:

- American Sign Language
- Arabic Armenian Russian

LACC is literally where worlds come together, situated between Little Armenia, Korea Town, Hollywood and Central and South American neighborhoods. This makes the college a particularly wonderful setting for learning a new language or mastering the language of your parents or grandparents. Understanding a foreign language can: Increase your understanding of other cultures and/or your own; enrich your travel experiences abroad; and open career opportunities. Language skills are prized by employers, especially in teaching, translating, social work, foreign service, international relations, trade and any other occupations catering to multi-cultural and international audiences.

DEGREE PROGRAMS

FOREIGN LANGUAGES

Associate of Arts Degree

Transfer Program

CHINESE

Eighteen or more units of classes chosen from below. Must include Chinese 4 with a satisfactory grade or better.

Chinese 1	5
Chinese 2	5
Chinese 3	5
Chinese 4	5
Chinese 10	3
Chinese 21	3
Chinese 22	3

FRENCH

Eighteen or more units of classes chosen from below. Must include French 4 with a satisfactory grade or better.

French 1	5
French 2	5
French 3	5
French 4	5
French 8	2
French 10 (same as Humanities 42)	3

ITALIAN (CURRENTLY NOT OFFERED)

JAPANESE

Eighteen or more units of classes chosen from below.

Must include Japanese 4 with a satisfactory grade or better.

Japanese 1	5
Japanese 2	5
Japanese 3	5
Japanese 4	5
Japanese 8	2
Humanities 20	3

KOREAN

Eighteen or more units of classes chosen from below.

Must include Korean 4 and Korean 8 with a satisfactory grade or better.

Korean 1	5
Korean 2	5
Korean 3	5
Korean 4	5
Korean 8	2
Humanities 45 (same as Korean 10)	3

SPANISH

Eighteen or more units of classes chosen from below.

Must include Spanish 4, Spanish 9 and 10 with a satisfactory grade or better.

Spanish 1	5
Spanish 2	5
Spanish 3	5
Spanish 4	5
Spanish 5	5
Spanish 6	5
Spanish 8	2
Spanish 9	3
Spanish 10	3
Spanish 11	3
Spanish 15	3
Spanish 21	3

Spanish 22.....3
 Spanish 35.....5
 Spanish 36.....5
 Spanish 123.....3
 Spanish 124.....3

To complete general education requirements in this area of study, Plan A for the AA/AS Degree is required.

PLAN A: Please consult with a counselor about specific courses needed or see the college catalog "Graduation Requirements" section. Plan A is designed for transfer to a four-year college or university. However, requirements vary depending upon the individual institution.

Please consult with a counselor for the specific requirements of the university you plan to attend.

- 3-6 Units English Composition
- 6-9 Units Communication/Analytical Thinking
- 3 Units Natural Sciences
- 3 Units Humanities
- 9 Units Social/Behavioral Sciences (including American History & Governments)
- 3-4 Units Health/Physical Education
- 3-5 Units Math Competency

(Math 115 or higher or passing score on Los Angeles Community College District Math competency exam)

CERTIFICATE PROGRAMS

Korean Language & Civilization Certificate:

Intermediate Level

A certificate will be issued by the Foreign Language & Humanities Department upon successful completion of the following courses and submitting an application to the department. All course work must be completed at LACC with a satisfactory grade of C or better.

Korean 1.....5
 Korean 2.....5
 Korean 8.....2
 Or Humanities 45 (same as Korean 10).....3
Total Units.....15

Korean Language & Civilization Certificate:

Advanced Level

A certificate will be issued by the Foreign Language & Humanities Department upon successful completion of the following courses and submitting an application to the department. All course work must be completed at LACC with a satisfactory grade of C or better.

Korean 3.....5
 Korean 4.....5
 Korean 8.....2
 Or Humanities 45 (same as Korean 10).....3
Total Units.....15



HEALTH

Chair: John Erdhaus
(323) 953-4000 ext. 2860 • MG104

PROGRAMS OFFERED
Courses Only - No Degree/Certificate



HUMANITIES

Chair: Eiko Kitajima Chatel
(323) 953-4000 ext. 2737 •
DH312B

www.lacitycollege.edu/academic/departments/forlang/index.html

PROGRAMS OFFERED
Associate of Arts: Humanities

DEGREE PROGRAM

HUMANITIES

Associate of Arts Degree

Transfer Program

The following curriculum is an interdisciplinary studies sequence that brings together art, music, history, literature, and cultural studies. It provides a strong foundation for a wide range of undergraduate majors, including the arts, literature, history, world cultures as well as ethnic and gender studies.

A minimum of 18 units of Arts and Humanities is required for the Humanities major Associate Degree. Requirements for the major are to be chosen from the Plan A Graduation requirements under the Humanities section.

HUMANITIES - ARTS: .3 units from any of the following:

African American Studies, Architecture, Art, Asian American Studies, Chicano Studies, Cinema, Music, Photography, Theater

HUMANITIES - LITERATURE: .3 units from any of the following

African American Studies, English

HUMANITIES - 3-5 units from any of the following

FOREIGN LANGUAGE:

All courses in Arabic, Armenian, Chinese, French, Italian, Japanese, Korean, Russian, Spanish and American Sign Language

HUMANITIES - HUMANITIES: .6 units from any of the following

Humanities 6, 8, 20, 30, 31, 45, 47, 61, 63,

Elective Units: Choose from any course listed under any section to bring total to a minimum of 18 units

Total Units 18-20

To complete general education requirements in this area of study, Plan A for the AA/AS Degree is required.

PLAN A: Please consult with a counselor about specific courses needed or see the college catalog "Graduation Requirements" section. Plan A is designed for transfer to a four-year college or university. However, requirements vary depending upon the individual institution. Please consult with a counselor for the specific requirements of the university you plan to attend.

- 3-6 Units English Composition
- 6-9 Units Communication/Analytical Thinking
- 3 Units Natural Sciences
- 3 Units Humanities
- 9 Units Social/Behavioral Sciences (including American History & Governments)
- 3-4 Units Health/Physical Education
- 3-5 Units Math Competency

(Math 115 or higher or passing score on Los Angeles Community College District Math competency exam)



JOURNALISM

Chair: Daniel Marlos
(323) 953-4000 ext. 2835
Chemistry Basement

PROGRAMS OFFERED
Associate of Arts:
Journalism

The journalism curriculum is an open-ended program that is arranged so the graduate is prepared to work in either the field or, with additional course work, to transfer to a four-year college or university. Journalism majors are offered courses designed to train them in desktop publishing skills and for editorial, and photojournalism jobs on daily and weekly newspapers, magazines, trade journals and consumer publications. They also are prepared for work as freelance writers and as writers for television and radio news programs. The employment records of hundreds of graduates show the California Publishers Association approval of courses offered here.

DEGREE PROGRAMS

JOURNALISM

Associate of Arts Degree

Transfer/Career Program

The curriculum is outlined below. Although the order and semester in which courses are taken may have to be modified to meet individual needs, all first semester journalism majors should enroll for every course listed below under First Semester. Courses listed are needed for the Associate of Arts Degree with a major in journalism. The candidate for graduation in this curriculum must have at least a "C" grade point average in the journalism courses taken.

Journalism majors also are required to work three semesters on the campus newspaper, the Collegian. Scholarships, from the Greater Los Angeles Press Club, are available for journalism majors.

JOURNALISM

Associate of Arts Degree

Transfer Program

First Semester	
Journalism 101**	3
Journalism 105	3
Photography 10	3

Second Semester

Journalism 2172
 Journalism 2183
 Journalism 2191
 Photography 73
 Photography 204
Total Units22

** Required of first semester majors unless waived by Department Chair.

Suggested Electives to meet additional 6 units in general education requirements: English 102; Journalism 217; Journalism 218 (repeated); Photography 15, 34 or 46, Art 101, Political Science 2, Political Science 7, Law 3, History 12 or History 13.

Additional Electives: Cinema 3 or Cinema 4, Journalism 185, Journalism 285 Photography 107 and 207.

To complete general education requirements in this area of study, Plan A for the AA/AS Degree is required.
 PLAN A: Please consult with a counselor about specific courses needed or see the college catalog

"Graduation Requirements" section. Plan A is designed for transfer to a four-year college or university. However, requirements vary depending upon the individual institution. Please consult with a counselor for the specific requirements of the university you plan to attend.

- 3-6 Units English Composition
- 6-9 Units Communication/Analytical Thinking
- 3 Units Natural Sciences
- 3 Units Humanities
- 9 Units Social/Behavioral Sciences (including American History & Governments)
- 3-4 Units Health/Physical Education
- 3-5 Units Math Competency

(Math 115 or higher or passing score on Los Angeles Community College District Math competency exam)

JOURNALISM

Associate of Arts Degree

Career Program

First Semester

Journalism 101*3
 Journalism 1053
 Photography 103

Second Semester

Journalism 2172
 Journalism 2183
 Journalism 2191
 Photography 73
 Photography 204
 Library Science 1011
 Art 6333

Third Semester

Journalism 2172
 Journalism 2183
 Journalism 2191
 Electives9

Fourth Semester

Journalism 2172
 Journalism 2183
 Journalism 2191
 Electives9
Total Units56

To complete general education requirements in this area of study, Plan B for the AA/AS

Degree is required.

PLAN B: Please consult with a counselor about specific courses needed or see the college catalog "Graduation Requirements" section. Plan B is not designed for transfer to a four-year college.

- 3 Units English Composition
- 3 Units Communication/Analytical Thinking
- 3 Units Natural Sciences
- 3 Units Humanities
- 3 Units Social/Behavioral Sciences (including American History & Governments)
- 3-4 Units Health/Physical Education
- 3-5 Units Math Competency



LAW

Chair and Paralegal Program Coordinator:

Wilhelm Vargas, Attorney at Law
(323) 953-4000 ext. 2754 • HH200 F

www.lacitycollege.edu/academic/departments/law/index.html

PROGRAMS OFFERED

- Associate of Arts:**
- Paralegal Studies**
- Business Law**

The PARALEGAL STUDIES PROGRAM is offered by the Law Department to students who are interested in the legal field. Paralegals assist attorneys in providing legal services in civil and criminal matters. Paralegal training is also valuable to persons seeking employment in fields such as real estate, insurance, banking, or brokerage. According to the latest statistics from the Bureau of Labor Statistics, the job outlook for the field of Paralegals and legal assistants are projected to grow faster than the average for all occupations through 2012. Despite projections of fast employment growth, competition for these jobs is rigorous and only the highly skilled, formally trained paralegals have excellent employment potential. The paralegal program is designed to provide students with high quality paralegal training, and on-the-job experience through internships. The paralegal program is flexible and accommodates day, evening, and weekend students.

Our BUSINESS LAW degree is ideal for students looking to go on to law school as it concentrates on the material covered in law school.

DEGREE PROGRAMS

PARALEGAL STUDIES

Associate of Arts Degree (Pending State Approval)

Career Program

According to California Business and Professions Code section 6450, “Paralegal” means a person who holds himself or herself out to be a paralegal, who is qualified by education, training, or work experience, who either contracts with or is employed by an attorney, law firm, corporation, governmental agency, or other entity, and who performs substantial legal work under the direction and supervision of an active member of the State Bar of California, or an attorney practicing law in the federal courts of this state, that has been specifically delegated by the attorney to him or her. Paralegals may not provide legal services directly to the public, except as permitted by law.

Employment growth for paralegals stems from law firms increasingly hiring paralegals to lower the cost and increase the availability and efficiency of legal services. The majority of job openings for paralegals in the future will be new jobs created by employment growth, but additional job openings will arise as people leave the occupation. While the program cannot guarantee employment, every effort is made to assist students in finding law related positions.

All students in the Law/Paralegal program are welcome to join the on-campus Law Society. Los Angeles City College is a member of the American Association for Paralegal Education (AAfPE). All Paralegal students are encouraged to be active in the Los Angeles Paralegal Association.

The A.A. Degree consists of 18 units in General Education and 42 units in the Paralegal Studies program major, for a total of 60 - 64 units. Students considering transferring law / paralegal credits from another college should meet with the chair of the law department.

ALL prerequisite courses must be taken in sequential order. In addition to Major requirements, the student must satisfy ALL the requirements of Plan “B” for completion of an Associate of Arts Degree. All courses must be completed with a “C” or better. Plan “B” is not a program designed for transfer to a four-year college. For assistance in completing the Plan “B” requirements, please meet with a Counselor in the Counseling Office, see the college catalog; or go online at www.lacitycollege.edu and click on the Class Schedule and Catalog link. This will give you more information regarding class requirements, class descriptions, and necessary units.

The Paralegal Program at Los Angeles City College may accept general education courses and non-paralegal specific courses as transferable credits that have earned a grade of “C” or better. The student must complete all Paralegal specific core classes (7 courses minimum) at Los Angeles City College. The transferred credits must have been earned at a fully accredited institution. All acceptable transferred credits will count toward the student’s grade point average (GPA) for graduation. The student must meet all applicable graduation requirements existing at the time of enrollment into the Paralegal Program.

In order to earn a Certificate in Paralegal Studies, the student must take the necessary Paralegal courses (42 units) as outlined below (with a grade of “C” or better) and already have earned one of the following: Bachelor or higher degree from an accredited educational institution or have previously earned an A.A. degree and completed the General Education requirements outlined for our Paralegal Studies program (see Plan “B” requirements below).

First Semester	
CAOT 84.....	3
English 101.....	3
Law 10.....	3
Library Science 101.....	1

Second Semester	
Law 1.....	3
Law 11.....	3
Law 12.....	3
Law 51.....	3

Third Semester	
Law 2.....	3
Law 17.....	3
CAOT 93.....	3
Electives (see list below).....	3

Fourth Semester	
Law 4.....	3
Law 19.....	3
Electives (see list below).....	3

Total Units43

With the exception of Law 1, Law 2, and Law 3 – students must first successfully complete Law/Paralegal 10 prior to taking any Paralegal Core courses (Core courses are bolded above).

Paralegal General Electives: Law 3, 13, 18, 33, 35, 37, 38

To complete general education requirements in this area of study, Plan B for the AA/AS Degree is required.

PLAN B: Please consult with a counselor about specific courses needed or see the college catalog “Graduation Requirements” section. Plan B is not designed for transfer to a four-year college.

3 Units	English Composition
3 Units	Communication/Analytical Thinking
3 Units	Natural Sciences
3 Units	Humanities
3 Units	Social/Behavioral Sciences (including American History & Governments)
3-4 Units	Health/Physical Education
3-5 Units	Math Competency

BUSINESS LAW

Associate of Arts Degree

Career Program

The Business Law curriculum is designed for students interested in a career in law; students going into public service, business, or other types of work where a general knowledge of the law is valuable. Transferring

To complete Plan “B” Graduation Requirements for the Associate degree, 37 units of the courses listed below must be completed. In addition, the student must complete at minimum 18 units in General Education. Students may not use the same course for credit toward the Major and the General Education requirements for the Associate degree. Sixty (60) total units are required for graduation in Plan “B”. Please consult with a counselor about specific courses needed or see the college catalog “Graduation Requirements” section.

First Semester

Business Law 13
 English 101.....3
 Library Science 101.....1
 CAOT 84.....3

Second Semester

Business Law 23
 Law 3.....3
 Law 14.....3

Third Semester

Law 15.....3
 Law 38.....3
 English 103.....3

Fourth Semester

Law 13.....3
 Law 14.....3
 Law 16.....3
 Law 19.....3

Total Units37

To complete general education requirements in this area of study, Plan B for the AA/AS Degree is required.
 PLAN B: Please consult with a counselor about specific courses needed or see the college catalog "Graduation Requirements" section. Plan B is not designed for transfer to a four-year college.
 3 Units English Composition
 3 Units Communication/Analytical Thinking
 3 Units Natural Sciences
 3 Units Humanities
 3 Units Social/Behavioral Sciences (including American History & Governments)
 3-4 Units Health/Physical Education
 3-5 Units Math Competency



**LIBERAL
ARTS**

**See a Counselor for Info.
Interdisciplinary Program**

**PROGRAMS OFFERED
Associate of Arts: Liberal Arts AA Degree**

DEGREE PROGRAM

LIBERAL ARTS

**Associate in Arts Degree & Transfer Major
Transfer Program**

The Liberal Arts degree is designed for students planning to transfer to a four year college/university, including the California State University (CSU) and the University of California (UC) system. This degree provides a well-rounded academic education in the liberal arts and sciences.

The Liberal Arts degree consists of the following: 1) general education requirements, 2) 18 units in an area of emphasis, and 3) electives, for a total of 60 units.

• Select one of the three options to meet general education requirements:

- Option 1. Los Angeles City College Plan A General Education (30 units min.).
- Option 2. CSU GE Breadth Certification (39 units min.). Option 2 must include a health course (CSU GE - Area E). Option 2 must also include one physical education/dance activity course.
- Option 3. IGETC Certification (37 units min.). Option 3 must include American Institutions/Government requirement. Option 3 must also include a health and physical education/dance activity course.

- Choose an Area of Emphasis (18 units min.)
- Complete electives for the required 60 total units for the AA degree



**LEARNING
SKILLS**

**Chair: Maryanne Des Vignes
(323) 953-4000 ext. 2770 •
LRC103C**

www.lacitycollege.edu/resource/learningskills/index.html

**PROGRAMS OFFERED
Courses Only - No Degree/Certificate**

Areas of Emphasis Social and Behavioral Sciences

These courses emphasize the perspective, concepts, theories and methodologies found in the social and behavioral sciences. Students will study about themselves and others as members of a larger society. This pattern emphasizes the contributions and perspectives of men, women and members of various ethnic and cultural groups and a comparative perspective on both Western and non-Western societies.

African American Studies 2, 4, 5, 7 Asian American Studies 1
 Anthropology 102, 103 Business 1
 Chicano Studies 7, 8 Child Development 1
 Economics 1, 2 Geography 2
History 1, 2, 3, 4, 5, 6, 8, 11, 12, 13, **59, 81, 82**, 86, 87
 Journalism 105
 Law 3
 Linguistics 2, 3
 Political Science 1, 2, 7
 Psychology 1, 13, 18
 Sociology 1, 2, 11
 Speech 122

Natural Sciences and Mathematics

These courses emphasize the natural sciences which examine the physical universe, its life forms, and its natural phenomena. Courses in mathematics emphasize the development of mathematical and quantitative reasoning beyond the level of intermediate algebra.

Anatomy 1
 Anthropology 101, 111
 Astronomy 1, 5, 10, 11
 Biology 1, 3, 6, 7, 25
 Chemistry 51, 60 or 68, 101, 101, 102, 211, 212, 221
 Earth Science 1
 Geography 1, 3, 15
 Geology 1, 6
Mathematics 227, 230, 236, 237, **245**, 260, 261, 262, 263, 270, 272, 275
 Meteorology 3
 Microbiology 1, 20
 Oceanography 1
 Physical Science 1, 13, 14
 Physics 6, 7, 11, 12, 14, 21, 22, 101, 102, 103
 Physiology 1
 Psychology 2

Arts and Humanities

These courses bring together art, music, history, literature, and cultural studies. Students will interpret the ways in which people through the ages in different cultures have responded to themselves and the world around them in artistic and cultural creation.

African American Studies 20, 21, 60 (Music 135)

American Sign Language 40

Art 101, 102, 103, 105, 107, (Chicano Studies 52), 109, 111, 201, 209, 501

Chicano Studies 44, 52 (Art 107)

Cinema 3, 4

Dance 805

English 203, 204, 205, 206, 208, 211, 212, 214, 215, 216, 218, 219, 221, 239, 240, 252, 253, 255, 270

Foreign Language courses including American Sign Language

Humanities 6, 8, 19, 20, 30, 31, 41 (Chinese 10), 42 (French 10), 44

(Italian 10), 45 (Korean 10), 47 (Spanish 9), 48, (Spanish 10), 61, 63

Music 101, 111, 121, 122, 133, 135 (African American Studies 60)

Philosophy 1, 2, 12, 14, 19, 20, 30, 32, 35, 40, 41

Photography 10, 17, 34

Speech 130

Theater 100, 110, 140

Performing and Visual Arts

These courses bring together the performing disciplines of Art, Cinema/TV, Dance, Photography, Music, and Theater. The students will demonstrate through performance how these disciplines integrate and relate to another. Students will be encouraged to work on the interdisciplinary aspect in the 185 Directed Studies through departmental collaborative projects.

A minimum of 18 units from the following 4 of the 6 disciplines below:

Choose a total of 12 units from 2 of the disciplines and the remaining 6 units from 2 of the other disciplines: Art, Cinema/TV, Dance, Music, Photography, and Theater.

Art 201, 501

Cinema 2

Dance Specialties 459

Dance Studies 185, 452

Dance Techniques 400, 431, 434, 437, 466, 467, 468

Dance Techniques 440, 446 or Dance Specialties 440, 446

Music 185, or 311 or 400 or 601 or 621, and 501

Photography 1, 10

Theater 200, 271, 225, 240, 300, 311, 313, 314, 315, 325, 336, 338, 416, 417

Choose one of the following courses for the Arts and Humanities General Education Area: Art 101, 102, 103, 105, 107, 109; Cinema 3, 4; Dance Studies 805; Music 111, 121, 122, 133, 135; Photography 34; Theater 110, 400



LIBRARY SCIENCE

Chair: Barbara Vasquez
(323) 953-4000 ext. 2407 • LIB114
<http://www.lacitycollege.edu/resource/library/index.html>

PROGRAMS OFFERED
Courses Only - No Degree/Certificate

The Library department is designed to help students succeed in their college classes. The courses give students confidence in doing research using standard library resources as well as the Internet.

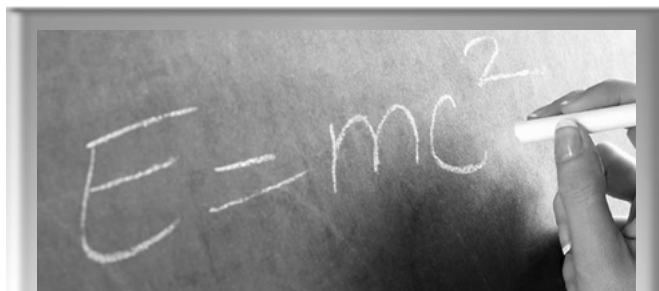

MATH

Chair: Roger Wolf
(323) 953-4000 ext. 2810 • JH 312
www.lacitycollege.edu/academic/departments/math/mathdept/index.html

PROGRAMS OFFERED
Associate of Science:
Mathematics

Mathematicians and their models put man and machines in space, make millionaires out of investors, and even propel video gaming technology to new levels of excitement. Mathematicians are active in just about every professional area you can think of and are typically in-demand and high earners. Here are just a few of the places you'll find them: Computer Animation; Virtual Environments; Digital Special Effects in Movies; Space Research; Mathematical Evolution and Modeling; Engineering; Software Development & Computer Technology; Electronics; Business (Financial Models, Trend Analysis, etc); Military & Security Occupations; Oil Exploration; and Teaching.

The LACC Mathematics Department offers from Pre-Algebra to Advanced Calculus and Differential Equations. Our students successfully transfer to prestigious university programs including Cal State Universities, UCLA, UC Berkley and other UCs, USC and CalTech to name a few. And, LACC's math team has consistently placed in the top 5 out of nearly 200 colleges in the National American Mathematics Association of Two Year Colleges Competition in recent years.

Placement Information

High school courses are not accepted as equivalent to college courses. Every new incoming student will be required to take the math assessment unless he/she has satisfied the prerequisite by a college level course or a comparable assessment process from another college (must not be based on high school transcripts). Those students placing above Math 125 please note: If the placement information given to you does not fit your circumstances, see Math Department for more detailed evaluation.

DEGREE PROGRAM

MATHEMATICS

Associate of Science Degree

Transfer Program

The curriculum shown below is designed to guide students in the Mathematics major and to encourage students to start courses in this major early in their college career. By completing this curriculum, students will be ready to compete in this major with other students at a four-year college or university. Whether or not students elect to receive the Associate of Science degree, the courses listed below are those that will prepare them to enter their transfer institutions fully prepared to pursue the Mathematics major.

First Semester

Mathematics 135	1
Mathematics 261	5

Second Semester

Mathematics 262	5
Mathematics 270	3

Third Semester

Mathematics 263	5
-----------------------	---

Fourth Semester

Mathematics 275	3
-----------------------	---

Total Units21

Depending on your preparation, you may need additional prerequisite courses before entering this program.

To complete general education requirements in this area of study, Plan A for the AA/AS Degree is required.

PLAN A: Please consult with a counselor about specific courses needed or see the college catalog

"Graduation Requirements" section. Plan A is designed for transfer to a four-year college or university. However, requirements vary depending upon the individual institution. Please consult with a counselor for the specific requirements of the university you plan to attend.

- 3-6 Units English Composition
- 6-9 Units Communication/Analytical Thinking
- 3 Units Natural Sciences
- 3 Units Humanities
- 9 Units Social/Behavioral Sciences (including American History & Governments)
- 3-4 Units Health/Physical Education
- 3-5 Units Math Competency

(Math 115 or higher or passing score on Los Angeles Community College District Math competency exam)

MATHEMATICS COURSE SEQUENCE

The LACC Assessment Center's process places student at the proper level in this sequence.

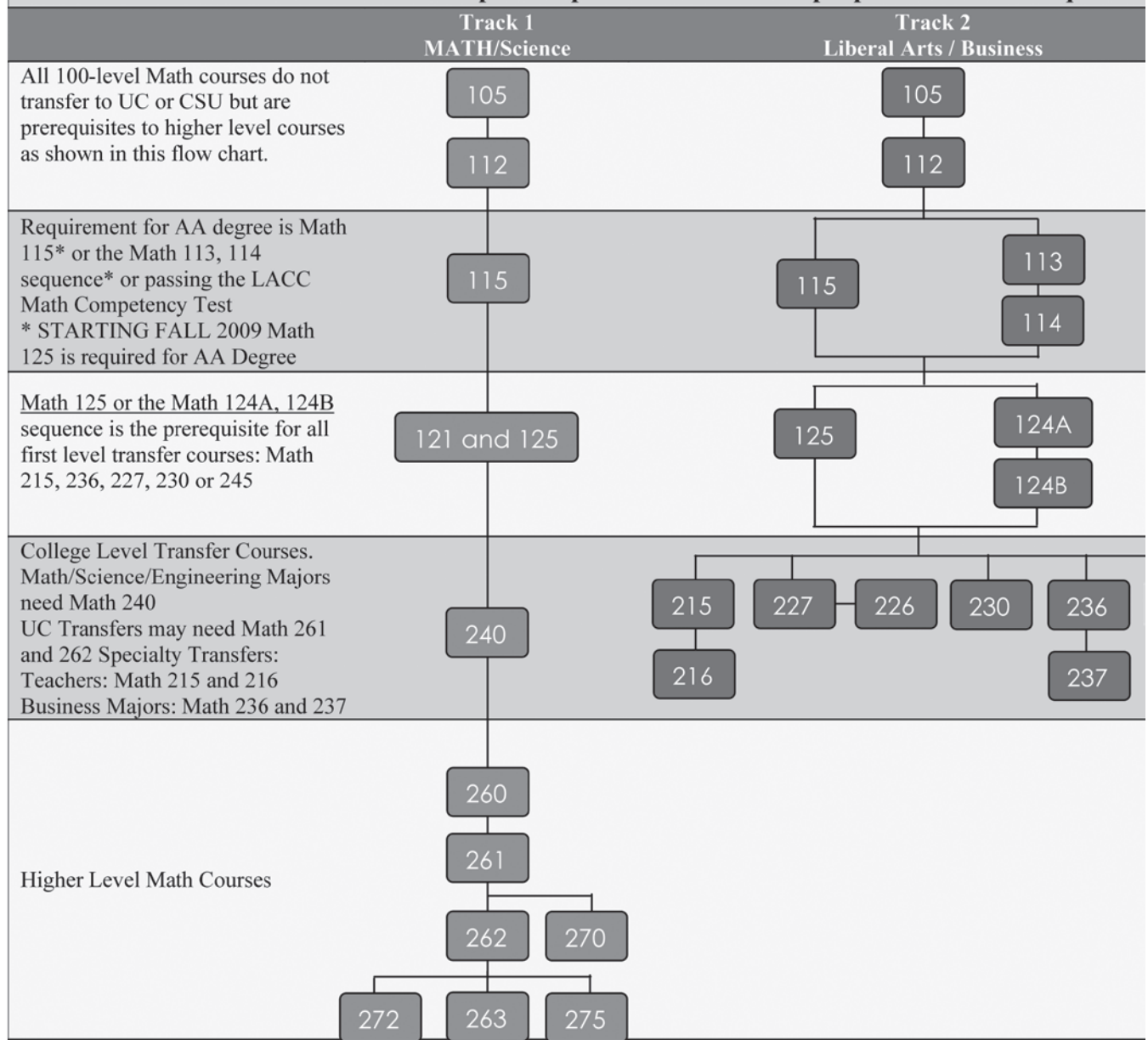

Math Tutoring Lab
 π Shop
100
202

Using the
Computer for Math
135

- Math 105 – Arithmetic for College Students
- Math 112 – Pre-Algebra
- Math 113 – Elementary Algebra A
- Math 114 – Elementary Algebra B
- Math 115 – Elementary Algebra
- Math 121 – Essentials of Geometry
- Math 124A – Intermediate Algebra A
- Math 124B – Intermediate Algebra B
- Math 125 – Intermediate Algebra
- Math 215 – Principles of Mathematics I
- Math 216 – Principles of Mathematics II
- Math 226 – Elementary Statistics Problem Solving
- Math 227 – Statistics

- Math 230 – Mathematics for Liberal Arts
- Math 236 – Calculus for Business and Social science II
- Math 237 – Advanced Calculus for Business and Social Science III
- Math 240 – Trigonometry
- Math 245 – College Algebra
- Math 260 – Precalculus
- Math 261 – Calculus I
- Math 262 – Calculus II
- Math 263 – Calculus III
- Math 270 – Linear Algebra
- Math 272 – Methods of Discrete Mathematics
- Math 275 – Ordinary Differential Equations



MUSIC

Chair: Dr. Dan Wanner
(323) 953-4000 ext. 2880 • CH243

<http://music.lacitycollege.edu>

PROGRAMS OFFERED

Associate of Arts:
Music

Certificates/Skill Certificates:
Instrumental Performer:

Brass	(Level 1 - 4)
Guitar	(Level 1 - 4)
Organ	(Level 1 - 4)
Percussion	(Level 1 - 4)
Piano	(Level 1 - 4)
Strings	(Level 1 - 4)
Woodwinds	(Level 1 - 4)
Music Copyist	(Level 1 - 4)
Music Technology	(Level 1 - 4)
Orchestrator/Arranger	(Level 1 - 4)
Vocal Performer	(Level 1 - 4)

The LACC Music Department offers the highest quality music courses, designed for students seeking a variety of educational goals, including General Education; Certificate Programs that provide the knowledge, expertise and skills needed to obtain a job in the music industry; and the Associate of Arts (AA) Degree program, designed for students planning to transfer to four-year universities.

Our faculty members are dedicated teachers who are active in the music industry as arrangers, copyists, composers, theorists, sound engineers and performers who play and sing regularly as soloists and with professional ensembles.

Students have a variety of performance opportunities, giving public concerts in Commercial and Classical Voice, Piano and Chamber Ensemble, Choir, Orchestra, Percussion Ensemble, Guitar Ensemble and our famous

Studio Jazz Band. In addition to being performers, music majors enter such fields as Recording Industry (Producing, Engineering, Arranging); Television and Radio (Program Director, Music Licensing); Music Technology (Sound Editor); Composing (Commercial Jingles, TV/Film); Conducting; Music Business (Music Distributor, Marketing); Music Education; Music Librarian; Music Publishing (Music Editor, Copyrights); Music Therapy; Music Communications (Publisher, Reporter); Instrument Making and Repair and more.

DEGREE PROGRAM MUSIC

Associate of Arts Degree
Transfer/Career Program

The Music Major Core Curriculum is outlined below. Although the order and semester in which courses are taken may have to be modified to meet individual needs, all courses listed as requirements are needed for the Associate of Arts degree with a Major in Music. Students will select additional courses in Music needed for proficiency in particular performance areas, composition, and orchestration and arranging.

All students should see a music counselor in the Music Department for assistance in arranging their academic programs.

Please Note: 0.5 unit labs do not count towards the AA Degree.

First Semester

Music 152*	1
Music 200*	4
Music 300*	1
Music 311* (or more advanced level)	1
Performance Ensemble (See Below)*	1

Second Semester

Music 152*	1
Music 201*	3
Music 211*	2
Music 301*	1
Music 312* (or more advanced level)	1
Performance Ensemble (See Below)*	1

Third Semester

Music 111	3
Music 152	1
Music 202	3
Music 212	2
Music 302	1
Music 313 (or more advanced level)	1
Performance Ensemble (See Below)*	1

Fourth Semester

Music 152	1
Music 203	3
Music 213	2
Music 303	1
Music 314 (or more advanced level)	1
Performance Ensemble (See Below)*	1

Total Units38

The Performance Ensemble requirement may be satisfied by enrollment in and satisfactory completion of any of the following courses: Music 251, 351, 501, 511, 521, 531, 561, 705, 711, 725, 731, 751, 765, 771, 775, 781.

These starred () courses must be included in the minimum requirements

under Graduation Requirements “Plan A.” All courses in the core curriculum must be completed under Graduation Requirements “Plan B.” It is also strongly recommended that students consider auditioning for Applied Music in their primary performance area while at LACC.

Students may select “PLAN A” or “Plan B” general education requirements to graduate.

PLAN A: Please consult with a counselor about specific courses needed or see the college catalog “Graduation Requirements” section. Plan A is designed for transfer to a four-year college or university. However, requirements vary depending upon the individual institution. Please consult with a counselor for the specific requirements of the university you plan to attend.

- 3-6 Units English Composition
- 6-9 Units Communication/Analytical Thinking
- 3 Units Natural Sciences
- 3 Units Humanities
- 9 Units Social/Behavioral Sciences (including American History & Governments)
- 3-4 Units Health/Physical Education
- 3-5 Units Math Competency
(Math 115 or higher or passing score on Los Angeles Community College District Math competency exam)

PLAN B: Please consult with a counselor about specific courses needed or see the college catalog “Graduation Requirements” section. Plan B is not designed for transfer to a four-year college.

- 3 Units English Composition
- 3 Units Communication/Analytical Thinking
- 3 Units Natural Sciences
- 3 Units Humanities
- 3 Units Social/Behavioral Sciences (including American History & Governments)
- 3-4 Units Health/Physical Education
- 3-5 Units Math Competency

CERTIFICATE PROGRAMS

The Commercial Music Certificate curriculum has been designed to provide the student with means to acquire valuable knowledge, expertise, and marketable skills with which to obtain employment in the following areas:

- Instrumental Performer: Brass, Guitar, Organ, Percussion, Piano, Strings, Woodwinds
- Music Copyist
- Music Technology
- Orchestrator/Arranger
- Vocal Performer

Each Certificate is made up of four skill levels. A Skill Certificate will be awarded by the Music Department upon application by the student to the Department showing satisfactory completion of the requirements for each level. A Commercial Music Certificate will be awarded by the Music Department to a student who has successfully completed the four levels required for a given specialty.

Please Note: 0.5 unit labs do not count towards the Certificate Programs.

**COMMERCIAL MUSIC:
INSTRUMENTAL PERFORMER / BRASS
Certificate**

LEVEL I:

Music 152	1
Music 200	4
Music 241	1
Music 300	1
Music 311*	1
Music 601**	2
Performance Ensemble	1
(Select from Music 501, 711, 725, 731, 751, 775, 781)	
Music Electives	2

LEVEL II:

Music 152	1
Music 161	3
Music 201	3
Music 211	2
Music 301	1
Music 312*	1
Music 602**	2
Performance Ensemble	1
(Select from Music 711, 725, 731, 751, 775, 781)	

LEVEL III:

Music 152	1
Music 202	3
Music 212	2
Music 302	1
Music 313*	1
Music 603**	2
Performance Ensemble	1
(Select from Music 725, 731, 751, 775, 781)	
Music Electives	2

LEVEL IV:

Music 152	1
Music 230	3
Music 251	1
Music 604	2
Performance Ensemble	1
(Select from Music 725, 731, 751, 775, 781)	
English 28***	3
Music 137 or Law 33	3

Total Units 54

**COMMERCIAL MUSIC:
INSTRUMENTAL PERFORMER / GUITAR
Certificate**

LEVEL I:

Music 152	1
Music 200	4
Music 241	1
Music 300	1
Music 311*	1
Music 650**	2
Performance Ensemble	1
(Select from Music 501, 711, 725, 771, 775, 781)	
Music Electives	2

LEVEL II:

Music 152	1
Music 161	3
Music 201	3
Music 211	2
Music 301	1
Music 312*	1
Music 651**2	1
Performance Ensemble	1
(Select from Music 711, 725, 771, 775, 781)	

LEVEL III:

Music 152	1
Music 202	3
Music 212	2
Music 302	1
Music 313*	1
Music 652**	2
Music 670	2
Performance Ensemble	1
(Select from Music 711, 725, 771, 775, 781)	

LEVEL IV:

Music 152	1
Music 230	3
Music 251	1
Music 653**	2
Performance Ensemble	1
(Select from Music 711, 725, 771, 775, 781)	
English 28***	3
Music 137 or Law 33	3

Total Units54

- * Or more advanced piano level determined by fulfillment of prerequisite or by departmental audition.
- ** Or more advanced Guitar level determined by fulfillment of prerequisite or by departmental audition.
- *** If English 28/31 requirement is met by a higher placement determined by the College Assessment, the English requirement is fulfilled; therefore, in place of English, you must take 3 units of Music.

**COMMERCIAL MUSIC:
INSTRUMENTAL PERFORMER / ORGAN
Certificate**

LEVEL I:

Music 152	1
Music 200	4
Music 241	1
Music 300	1
Music 311*	1
Performance Ensemble**	1
Music Electives***	4

LEVEL II:

Music 152	1
Music 161	3
Music 201	3
Music 211	2
Music 301	1
Music 312*	1
Performance Ensemble**	1
Music Elective ***	1

LEVEL IV:

Music 152	1
Music 202	3
Music 212	2
Music 302	1
Music 313*	1
Music 381****	1
Performance Ensemble**	1
Music Electives	3

LEVEL IV:

Music 152	1
Music 230	3
Music 251	1
Performance Ensemble**	1
Music 382****	1
English 28*****	3
Music 137 or Law 33	3

Total Units52

- * Or more advanced piano level determined by fulfillment of prerequisite or by departmental audition.
- ** Select from Music 351, 501, 511, 521, 531, 561, 705, 711, 725, 731, 751, 765, 771, 775, 781.
- *** If piano proficiency is 313 or above, student is strongly recommended to take Music 381 or higher.
- **** Or more advanced organ level determined by fulfillment of prerequisite or by departmental audition.
- ***** If English 28/31 requirement is met by a higher placement determined by the College Assessment, the English requirement is fulfilled; therefore, in place of English, you must take 3 units of Music.

**COMMERCIAL MUSIC:
INSTRUMENTAL PERFORMER / PERCUSSION
Certificate**

LEVEL I:

Music 152	1
Music 200	4
Music 241	1
Music 300	1
Music 311*	1
Music 631**	2
Performance Ensemble	1
(Select from Music 501, 711, 725, 731, 751, 765, 775, 781)	
Music Electives	2

LEVEL II:

Music 152	1
Music 161	3
Music 201	3
Music 211	2
Music 301	1
Music 312*	1
Music 632**	2
Performance Ensemble	1
(Select from Music 711, 725, 731, 751, 765, 775, 781)	

LEVEL III:

Music 152	1
Music 202	3
Music 212	2
Music 302	1
Music 313*	1
Music 633**	2
Performance Ensemble	1
(Select from Music 711, 725, 731, 751, 765, 775, 781)	
Music Electives	2

LEVEL IV:
 Music 1521
 Music 2303
 Music 2511
 Music 6342
 Performance Ensemble1
 (Select from Music 711, 725, 731, 751, 765, 775, 781)
 English 28***3
 Music 137 or Law 333
Total Units54

* Or more advanced piano level determined by fulfillment of prerequisite or by departmental audition.
 ** Or more advanced percussion level determined by fulfillment of pre-requisite or by departmental audition.
 *** If English 28/31 requirement is met by a higher placement determined by the College Assessment, the English requirement is fulfilled; therefore, in place of English, you must take 3 units of Music.

**COMMERCIAL MUSIC:
 INSTRUMENTAL PERFORMER / PIANO
 Certificate**

LEVEL I:
 Music 1521
 Music 2004
 Music 2411
 Music 3001
 Music 311*1
 Performance Ensemble**1
 Music Electives4

LEVEL II:
 Music 1521
 Music 1613
 Music 2013
 Music 2112
 Music 3011
 Music 312*1
 Performance Ensemble**1
 Music Elective1

LEVEL III:
 Music 1521
 Music 2023
 Music 2122
 Music 3021
 Music 313*1
 Music 3612
 Performance Ensemble**1
 Music Electives2

LEVEL IV:
 Music 1521
 Music 2303
 Music 2511
 Music 3612
 Performance Ensemble**1
 English 28***3
 Music 137 or Law 333
Total Units53

* Or more advanced piano level determined by fulfillment of prerequisite or by departmental audition.
 ** Select from any of the following: 351, 501, 511, 521, 531, 561, 705, 711, 725, 731, 751, 765, 771, 775, 781.
 *** If English 28/31 requirement is met by a higher placement determined by the College Assessment, the English requirement is fulfilled; therefore, in place of English, you must take 3 units of Music.

**COMMERCIAL MUSIC:
 INSTRUMENTAL PERFORMER / STRINGS
 Certificate**

LEVEL I:
 Music 1521
 Music 2004
 Music 2411
 Music 3001
 Music 311*1
 Music 611**2
 Performance Ensemble1
 (Select from Music 501, 705, 711, 725, 775, 781)
 Music Electives2

LEVEL II:
 Music 1521
 Music 1613
 Music 2013
 Music 2112
 Music 3011
 Music 312*1
 Music 612**2
 Performance Ensemble1
 (Select from Music 705, 711, 725, 775, 781)

LEVEL III:
 Music 1521
 Music 2023
 Music 2122
 Music 3021
 Music 313*1
 Music 613**2
 Performance Ensemble1
 (Select from Music 705, 711, 725, 775, 781)
 Music Electives2

LEVEL IV:
 Music 1521
 Music 2303
 Music 2511
 Music 6142
 Performance Ensemble1
 (Select from Music 705, 711, 725, 775, 781)
 English 28***3
 Music 137 or Law 333

Total Units54

* Or more advanced piano level determined by fulfillment of prerequisite or by departmental audition.
 ** Or more advanced string level determined by fulfillment of prerequisite or by departmental audition.
 *** If English 28/31 requirement is met by a higher placement determined by the College Assessment, the English requirement is fulfilled; therefore, in place of English, you must take 3 units of Music.

**COMMERCIAL MUSIC:
INSTRUMENTAL PERFORMER / WOODWINDS
Certificate**

LEVEL I:
 Music 1521
 Music 2004
 Music 2411
 Music 3001
 Music 311*1
 Music 621**2
 Performance Ensemble1
 (Select from Music 501, 711, 725, 731, 751, 775, 781)
 Music Electives2

LEVEL II:
 Music 1521
 Music 1613
 Music 2013
 Music 2112
 Music 3011
 Music 312*1
 Music 622**2
 Performance Ensemble1
 (Select from Music 711, 725, 731, 751, 775, 781)

LEVEL III:
 Music 1521
 Music 2023
 Music 2122
 Music 3021
 Music 313*1
 Music 623**2
 Performance Ensemble 1
 (Select from Music 711, 725, 731, 751, 775, 781)
 Music Electives2

LEVEL IV:
 Music 1521
 Music 2303
 Music 2511
 Music 6242
 Performance Ensemble1
 (Select from Music 711, 725, 731, 751, 775, 781)
 English 28***3
 Music 137 or Law 333

Total Units51-54

* Or more advanced piano level determined by fulfillment of prerequisite or by departmental audition.
 ** Or more advanced woodwind level determined by fulfillment of prerequisite or by departmental audition.
 *** If English 28/31 requirement is met by a higher placement determined by the College Assessment, the English requirement is fulfilled; therefore, in place of English, you must take 3 units of Music.

**COMMERCIAL MUSIC:
MUSIC COPYIST
Certificate**

LEVEL I:
 Music 1521
 Music 1613
 Music 2004
 Music 2411
 Music 3001
 Music 311*1
 Performance Ensemble**1
 Music Elective1

LEVEL II:
 Music 1521
 Music 2013
 Music 2112
 Music 2421
 Music 2613
 Music 3011
 Music 312*1
 Performance Ensemble1

LEVEL III:
 Music 1521
 Music 2023
 Music 2122
 Music 2431
 Music 3021
 Music 313*1
 Performance Ensemble**1
 Music 137 or Law 333

LEVEL IV:
 Music 1521
 Music 2303
 Music 2313
 Music 2441
 Music 2511
 Music 3612
 English 28***3

Total Units53

* Or more advanced piano level determined by fulfillment of prerequisite or departmental audition.
 ** Select from 351, 501, 511, 521, 531, 561, 705, 711, 725, 731, 751, 765, 771, 765, 771, 775, 781.
 *** If English 28/31 requirement is met by a higher placement determined by the College Assessment, the English requirement is fulfilled; therefore, in place of English, you must take 3 units of Music.

**COMMERCIAL MUSIC:
MUSIC TECHNOLOGY
Certificate**

LEVEL I:
 Music 1521
 Music 1613
 Music 2004
 Music 2411
 Music 3001
 Music 311*1
 Performance Ensemble**1
 Music Elective1

LEVEL II:

Music 152 1
 Music 201 3
 Music 211 2
 Music 261 3
 Music 301 1
 Music 312* 1
 Performance Ensemble** 1
 Music Elective 1

LEVEL III:

Music 152 1
 Music 202 3
 Music 212 2
 Music 291 2
 Music 302 1
 Performance Ensemble** 1
 English 28*** 3

LEVEL IV:

Music 230 or Music 231 3
 Music 251 1
 Music 281 3
 Music 292 2
 Performance Ensemble** 1
 Music Elective 1
 Music 137 or Law 33 3

Total Units 53

- * Or more advanced piano level determined by fulfillment of prerequisite or departmental audition.
- ** Select from 351, 501, 511, 521, 531, 561, 705, 711, 725, 731, 751, 765, 771, 765, 771, 775, 781.
- *** If English 28/31 requirement is met by a higher placement determined by the College Assessment, the English requirement is fulfilled; there- fore, in place of English, you must take 3 units of Music.

**COMMERCIAL MUSIC:
 ORCHESTRATOR/ARRANGER
 Certificate**

LEVEL I:

Music 152 1
 Music 200 4
 Music 241 1
 Music 300 1
 Music 311* 1
 Performance Ensemble** 1
 Instrumental Instruction 2
 (Select from Music 601, 611, 621, 631)
 Music Electives 2

LEVEL II:

Music 152 1
 Music 161 3
 Music 201 3
 Music 211 2
 Music 301 1
 Music 312 1
 Instrumental Instruction 2
 (Select from Music 601, 611, 621, 631)
 Performance Ensemble** 1

LEVEL III:

Music 152 1
 Music 202 3
 Music 212 2
 Music 302 1
 Music 313* 1
 Instrumental Instruction 2
 (Select from Music 601, 611, 621, 631)
 Performance Ensemble** 1
 Music 137 or Law 33 3

LEVEL IV:

Music 152 1
 Music 230 3
 Music 231 3
 Music 251 1
 Instrumental Instruction 2
 (Select from Music 601, 611, 621, 631)
 Performance Ensemble** 1
 English 28*** 3
 3

Total Units 55

- * Or more advanced piano level determined by fulfillment of prerequisite or by departmental audition.
- ** Select from 501, 711, 725, 731, 751, 765, 771, 775, 781.
- *** If English 28/31 requirement is met by a higher placement determined by the College Assessment, the English requirement is fulfilled; there- fore, in place of English, you must take 3 units of Music.

**COMMERCIAL MUSIC:
 VOCAL PERFORMER
 Certificate**

LEVEL I:

Music 152 1
 Music 200 4
 Music 241 1
 Music 300 1
 Music 311* 1
 Music 400** 1
 Performance Ensemble 1
 (Select from Music 501, 531, 561)
 Music Electives 3

LEVEL II:

Music 152 1
 Music 161 3
 Music 201 3
 Music 211 2
 Music 301 1
 Music 312* 1
 Music 431** 1
 Performance Ensemble 1
 (Select from Music 501, 531, 561)

LEVEL III:

Music 1
 Music 202 3
 Music 212 2
 Music 302 1
 Music 313* 1
 Music 432** 1
 Performance Ensemble 1
 (Select from Music 501, 531, 561)
 Music 137 or Law 33 3

LEVEL IV:

Music 152	1
Music 230	3
Music 251	1
Music 433	1
Performance Ensemble	1
(Select from Music 501, 531, 561)	
Music Electives	3
English 28***	3

Total Units 52

- * Or more advanced piano level determined by fulfillment of prerequisite or by departmental audition.
- ** Or more advanced voice level determined by fulfillment of prerequisite or by departmental audition.
- *** If English 28/31 requirement is met by a higher placement determined by the College Assessment, the English requirement is fulfilled; therefore, in place of English, you must take 3 units of Music.



NURSING

Director: Betsy Manchester
(323) 953-4000 ext. 2065
Cub Center

<http://www.lacitycollege.edu/academic/departments/nursing/index.html>

PROGRAMS OFFERED

**Associate of Science: Nursing,
Registered**

Other:

Certified Nursing Assistant :
 ARCHIVED until fall 2009/Spring 2010
Home Health Aide:
 ARCHIVED until Fall 2009/Spring 2010

RN Residency Program

theory and clinical courses over 4 days a week. Clinical experiences will include the opportunity for students to participate in nursing care and treatments of clients in hospitals and other health care facilities. Once admitted, this program is designed to be completed in four semesters for non-licensed candidates.

NCLEX-RN Exam

Students will be eligible to apply for and take the NCLEX-RN examination upon graduation. The Board of Registered Nursing may deny licensure on such grounds as: being convicted of crime, acts of dishonesty, fraud or deceit, etc. Persons impaired by alcohol, drug abuse and emotional illness are expected to voluntarily seek diagnosis and treatment for any suspected illness.

Prerequisites

As of Spring 2009, the Registered Nursing Program Prerequisites include completion of the following prerequisites with a minimum overall grade point average of 2.5. and no grade less than "C"

1. Human Anatomy (with lab)
2. Human Physiology (with lab)
3. Microbiology 1 or 20.
4. English 101 (College Reading and Comprehension) or equivalent with a minimum of a "C."

Additional Requirements

- Completion of, or proof of math Assessment comparable to Math 115.
- Completion of 1 year of High School Chemistry with a lab or equivalent (Chemistry 60 or 68)
- Overall college grade point average of 2.5
- Satisfactory score on the admission assessment test (contact Nursing Department for details)
- Satisfactory "cut score" of 80 or higher based on the Chancellor's validation study
- Completion of all of the admission requirements of Los Angeles City College
- Graduation from an accredited U.S. High School or equivalent or graduation from an accredited U.S. College or university or equivalent. If students received their high school diploma from a foreign country and/or are requested equivalency of foreign college credits to fulfill prerequisites, the transcripts must be evaluated for equivalency by an LACC approved agency.
- Students must also meet health and other requirements mandated by the program and affiliating hospitals and/or clinical prior to entry. For additional requirements, please attend one of the Information Sessions where details are discussed.

It is highly recommended that the following co-requisites/graduation requirements be completed prior to entry into the Registered Nursing Program. Those courses that have not been satisfactorily completed will need to be completed during the 4 semesters of the Registered Nursing program. It is the student's responsibility that the following courses be completed prior to graduation and taking the NCLEX-RN examination.

1. Sociology 1 or Anthropology 101- Must be completed prior to 4th semester.
2. Speech 101- Must be completed prior to 3rd semester
3. 3 units of American Institutions- Must be completed prior to 4th semester

DEGREE PROGRAM

Los Angeles City College reopened the Associate Degree Registered Nursing Program in Fall 2002. The college accepts 20-40 students for enrollment every Fall and Spring. Should the number of qualified applicants exceed the number of available openings, a simple lottery will be implemented.

The Associate Degree program is a 2-year full-time program that includes

4. 3 units of Humanities - Must be completed prior to 4th semester

5. 1 unit of P.E. - Must be completed prior to 4th semester

Please refer to Plan B or consult with the nursing counselor for further guidance.

Also note: The information presented may be updated or modified subject to district, state and/or BRN requests. The LACC Registered Nursing Curriculum is in the process of being modified to align with the other LACCD nursing programs in the district. These modifications may be in place by Fall 2009 if district and BRN approved.

First Semester

NRSGREG 103	1
NRSGREG 104	4
NRSGREG 105	5
Electives (Highly Recommended):	
NRSGREG 115.....	1

Second Semester

NRSGREG 106	4
NRSGREG 107	4
NRSGREG 116.....	1

Third Semester

NRSGREG 108	4
NRSGREG 109	5
NRSGREG 117	1

Fourth Semester

NRSGREG 110	5
NRSGREG 111	4

Total Required Units.....	38
(Total Units Including Electives	39)

Note to Current LVN's:

Current practicing LVN's are invited to complete the Associate Degree Registered Nursing Program by applying and being accepted into the second year of the program based on space availability. LVNs must have taken a 2 unit Transition/Bridge course. LVN candidates must complete the above prerequisites. This will enable licensed vocational nurses with 6 months clinical experience to complete requirements for the Registered Nursing Associate Degree in 1 year.

LACC also offers a 30-unit option for LVN's. Candidates who choose this option will not be graduates of the LACC Nursing Program. Also several states in the USA will not recognize nurses who take this option. Additional information is available about this option in the Nursing Department.

To complete general education requirements in this area of study, Plan B for the AA/AS Degree is required.

NOTE: The Plan B requirements for this program include 16 units in Natural Sciences

NOT 12 units as listed in Plan B under other programs in this catalog.

PLAN B: Please consult with a counselor about specific courses needed or see the college catalog

"Graduation Requirements" section. Plan B is not designed for transfer to a four-year college.

3 Units	English Composition
3 Units	Communication/Analytical Thinking
3 Units	Natural Sciences

3 Units Humanities

3 Units Social/Behavioral Sciences (including American History & Governments)

3-4 Units Health/Physical Education

3-5 Units Math Competency

(Math 115 or higher or passing score on Los Angeles Community College District Math competency exam)

RN RESIDENCY IN PEDIATRICS PROGRAM

Los Angeles City College's Nursing Program in partnership with Children's Hospital Los Angeles is offers a Registered Nurse Residency in Pediatrics Program. For information contact the Registered Nursing Department located in the Cub Center or contact Children's Hospital directly at (323) 660-2450 extension 5871.

A clinical placement is required for this course. Students will be responsible for securing and maintaining their clinical placement within the Children's Hospital Los Angeles ("CHLA") system.

CERTIFIED NURSING ASSISTANT PROGRAM

LACC also offers a Certified Nursing Program, Nursing 100 every semester. This is an 6 unit course that prepares students for the certified nursing assistant ARCHIVED until Fall 2009/Spring 2010 examination given by the Red Cross. Upon completion of the certification exam, students may enroll in the Home Health Aid course.



PERSONAL DEVELOPMENT

Chair: Reri Pumphrey
(323) 953-4000 ext. 2250 • AD108

PROGRAMS OFFERED
Courses Only - No Degree/Certificate

The Counseling Department offers life-skills courses providing students with opportunities to increase their potential for academic success, and in their future careers. Personal Development courses introduce students to Los Angeles City College programs and services, develop students' learning strategies, assist students with planning educational goals, and provide career/major exploration for undecided students. The Counseling Department believes that students should take time early in their college life to develop a comprehensive plan to meet their interests, values, abilities, and goals, improve their time-management skills and adopt other behaviors key to their success in college and beyond.



PHILOSOPHY

Chair: Julio Torres
(323) 953-4000 ext. 2763 • HH200

PROGRAMS OFFERED
 Courses Only - No Degree/Certificate

Too often when we hear "philosophy," the thought of old statues and ancient writings comes to mind. In fact, philosophy is alive and well and critical to our every day decision making and the decisions made by business, religious institutions and governments around the world. Additionally, examining the principles of philosophy helps in becoming a more ethical and organized thinker. These skills are critical for future managers. The logic skills gained can benefit anyone and especially aspiring lawyers who will need to present well structured arguments.



PHOTOGRAPHY

Chair: Daniel Marlos
(323) 953-4000 ext. 2835

Chemistry Basement
www.lacitycollege.edu/academic/departments/medarts/photo/index.html

PROGRAMS OFFERED
Associate of Arts:
 Applied Photography
Certificates:
 Photography - Commercial
 Photography - Freelance

The LACC program is nationally recognized as one of the most outstanding of its kind. Many LACC Photography majors become employed in the industry either during or after completion of the degree program. Students interested in photography as a hobby or because it relates to their career goals (e.g. journalism, public relations, art, real estate, business, cinema, etc.) will also benefit greatly from our class offerings.

DEGREE PROGRAM **PHOTOGRAPHY** **Associate of Arts Degree** **Career Program**

This curriculum will prepare you for a career in professional photography, as a photographer and/or photographic laboratory technician. Training includes lighting, design and professional techniques of color and black and white photography for various publication media, advertising, portraiture and display, using a wide variety of materials and techniques and state of the art equipment including digital cameras, inkjet printers and scanners. Students will be introduced to computer digital imaging technology, including instruction in Adobe Photoshop techniques, and Internet website design classes.

To enroll in Photography 1, you must complete Photography 10 or approval of 10 or more samples of your black and white work, by the instructor. You will need a manual (or automatic with fully manual capability) 35mm single lens reflex camera with a full range of adjustable apertures, shutter speeds and focusing. If you are in Photo 1 or above, you will have access to the department 4 x 5 view cameras and 120 size roll film cameras. Estimated semester expenses for film, paper and other personal supplies are about \$200 to \$300, depending on the class.

Courses required for the Associate of Arts degree and Certificate of Completion are as follows. Photography 1 is the prerequisite for most photography classes. See Course Descriptions for specific information.

REQUIRED PHOTOGRAPHY

Students may complete course work toward an Associate of Arts degree and/or Certificates of Completion in photography.

PHOTOGRAPHY **Associate of Arts Degree** **Career Program**

CORE	
Photo 10	3
Photo 1	6
Photo 28	1

- PLUS** complete requirements from Option A or B (below);
- AND** additional elective units to total 36 units in the major;
- PLUS** 18 units of general education requirements (consult with a counselor for specific courses);
- PLUS** additional elective units to total 60 units for the Associate of Arts degree.

Recommended courses including General Education for photography majors are Art 201, Art 204, Cinema 1, Cinema 2, CAOT 31, Journalism 101, Law 1, Photography 3, 6, 7, 15, 17, 20, 22, 34, 46, 49, 50, 107 and 207.

To complete general education requirements in this area of study, Plan B for the AA/AS Degree is required.

PLAN B: Please consult with a counselor about specific courses needed or see the college catalog "Graduation Requirements" section. Plan B is not designed for transfer to a four-year college.

- 3 Units English Composition
- 3 Units Communication/Analytical Thinking
- 3 Units Natural Sciences
- 3 Units Humanities
- 3 Units Social/Behavioral Sciences (including American History & Governments)
- 3-4 Units Health/Physical Education
- 3-5 Units Math Competency

CERTIFICATE PROGRAMS

A certificate in Commercial, or Freelance, Photography will be issued by the Media Arts Department upon application of the student with the department upon successful completion of the courses listed above with a satisfactory grade.

OPTION A: PHOTOGRAPHY Commercial Certificate

Photography 1	6
Photography 3	6
Photography 6	3
Photography 46	3
Photography	6
Photography 50	3

Total Units27

OPTION B: PHOTOGRAPHY Freelance Certificate

Photography 1	6
Photography 7	3
Photography 15	3
Photography 20	4
Photography 34	3
Photography 46	3
Photography 107	3
Photography 207	3

Total Units28

HEALTH ADVISORY FOR PHOTOGRAPHY

Because students enrolled in the Photography program are required to precisely mix photographic chemicals, some of which are toxic, it is advisable that a student be able to clearly understand oral instructions and reading materials that are distributed in class and lab. Consequently, it is advisable for students to possess reading comprehension at the English 28 level (Intermediate Reading and Composition) or higher.



PHYSICAL EDUCATION

Chair: John Erdhaus
(323) 953-4000 ext. 2860 • MG104
<http://athletics.lacitycollege.edu/>
<http://wpe.lacitycollege.edu/>

PROGRAMS OFFERED
Courses Only - No Degree/Certificate



PHYSICAL SCIENCE

Chair: Dr. Jayesh Bhakta
(323) 953-4000 ext. 2923 • SCI 222D
www.lacitycollege.edu/academic/departments/physics/

PROGRAMS OFFERED
Courses Only - No Degree/Certificate

The physical sciences, including geography, geology, and physical science, are related to environmental management, teaching, urban planning, geology and construction careers. These courses provide an opportunity to learn more about our environment, the earth and the forces that shape it.

**PHYSICS/
ASTRONOMY**

Chair: Jayesh Bhakta
(323) 953-4000 ext. 2923 • SCI 222D
www.lacitycollege.edu/academic/departments/physics/

PROGRAMS OFFERED Associate of Science Physics - General

Other Courses
 Astronomy

From falling apples to interplanetary spacecraft, high speed computer to the, all natural phenomena and man made technologies have the laws of physics at their core. Studying physics will help you develop an understanding and appreciation of the physical world and prepare you for further work in science, engineering, medical and technical fields.

The LACC Physics department offers classes for science and engineering majors, as well as classes and labs for non-science majors which meet transfer requirements. In addition to modern equipment, the department offers research experiences at Cal State LA and JPL (Jet Propulsion Laboratory), access to an on-campus observatory and computer controlled telescopes, and "Star Parties" – special astronomy field trips.

**DEGREE PROGRAM
PHYSICS**

**Associate of Science Degree
Transfer Program**

- This four semester sequence of courses serves two functions:
- 1) it provides a student with a two year Associate in Science degree as a physics major; and
 - 2) it provides the student with preparatory course work to transfer to a four-year university as a junior in physics or other related physical sciences.

All of the physics and mathematics courses listed here are prerequisites for upper division physics and mathematics courses for physics majors. Courses not completed at LACC must be taken at the university before entry into the upper division major program.

First Semester

Mathematics 261	5
English 101	3
General Education (American History).....	3

Second Semester

Physics 101	5
Mathematics 262	5
Chemistry 101	5
General Education (Speech Communication 101 or English 102	3

** Students transferring to the UC should take English 102.

Third Semester

Physics 102	5
Mathematics 263	5
Mathematics 275	3
General Education (Humanities)	3

Fourth Semester

Physics 103	5
Chemistry 102	5
General Education (Health Ed and PE) (Select one course from either Behavioral Science or Life Science).....	6

Total Units
 (includes general education requirements)61

Physics 101 and Mathematics 261 may be used to fulfill the General Education requirements (double count).

To complete general education requirements in this area of study, Plan A for the AA/AS Degree is required.
 PLAN A: Please consult with a counselor about specific courses needed or see the college catalog "Graduation Requirements" section. Plan A is designed for transfer to a four-year college or university. However, requirements vary depending upon the individual institution. Please consult with a counselor for the specific requirements of the university you plan to attend.

3-6 Units	English Composition
6-9 Units	Communication/Analytical Thinking
3 Units	Natural Sciences
3 Units	Humanities
9 Units	Social/Behavioral Sciences (including American History & Governments)
3-4 Units	Health/Physical Education
3-5 Units	Math Competency

(Math 115 or higher or passing score on Los Angeles Community College District Math competency exam)



PSYCHOLOGY

Chair: Rochelle Sechooler

**(323) 953-4000 ext. 2930 •
HH100G**

www.lacitycollege.edu/academic/departments/psych/index.html

PROGRAMS OFFERED Associate of Arts:
Human Services - Generalist
Human Services - Drug/Alcohol

Certificates:
Human Services - Generalist
Human Services - Drug/Alcohol

A career in Human Services is a career of making a difference for others while discovering more about yourself. Human Services professionals help people turn their lives around and find new directions. They assist the mentally ill, victims of abuse, children, addicts and others in need.

Human Services workers, on average, earn between \$20,000 - \$40,000 annually. Those who continue their education to become social workers can earn between \$25,000 - \$65,000 annually. Occupations include: Activity Director, Gang Counseling, Special Education Assistant, Domestic Violence Counselor, Senior & Teen Service Providers, Probation Office Assistant, Activity Director, Disabled Services, CalWORKS/GAIN Program Assistant, Childcare Worker, Social Worker Assistant, Mental Health Worker, Alcohol/Drug Abuse Counselor.

DEGREE PROGRAMS

HUMAN SERVICES Associate of Arts Degree Career Program

The Human Services curriculum, offered by the Department of Psychology, is a lower division two year course of study designed to train a student in one of two Options: Human Services Generalist or Drug/Alcohol Studies. The curriculum also serves as an introduction to the helping professions for students planning four year college degrees in Psychology, Human Services, Behavioral Science, Rehabilitation Counseling, Social Work, Health Science and Alcohol and Substance Abuse, and other majors. The Human Services Curriculum specifically trains paraprofessionals who are able to function in a wide variety of areas under professional supervision.

Students in the Human Services Generalist Option and the Drug/Alcohol Studies Option complete the same core courses. Academic preparation is offered in basic psychology courses such as Introductory Psychology, Personality and Social Development, and Abnormal Psychology. Another part of the core classes concentrates on important communication skills and self awareness through participating in Group Dynamics courses, which are conducted as laboratory workshops for the purpose of engaging in and learning about the group process. The third aspect of the core courses is a three semester rotation through Field Work courses, coordinated and taught by a faculty member, in cooperation with facilities in the community. These fieldwork courses are related to the student's special interests and the population with whom they expect to work in the future. By completing the courses listed below, students will be eligible for the Associate of Arts degree with a major in Human Services. Satisfactory completion of all courses with at least a "C" grade is required. Students should note that, while this curriculum culminates in an Associate of Arts degree and Human Services Certificate, additional courses are required for transfer to a four-year college.

HUMAN SERVICES GENERALISTS OPTION (2-Year Plan) Associate of Arts Degree Career Program

First Semester
Psychology 13
Psychology 433
*Physical Education

Second Semester
Psychology 143
Psychology 413
Psychology 443
Psychology 813
*Humanities Requirement

Third Semester
Psychology 33
Psychology 133
Psychology 823
*Science Requirement

Fourth Semester
Psychology 23
Psychology 453
Psychology 833

Total Units36

* American Institutions Requirement Elective
Students must meet the mathematics competency requirements for the Associate of Arts degree.

Recommended electives: Psychology 64, Psychology 52, Psychology 18 or Psychology 66.

To complete general education requirements in this area of study, Plan B for the AA/AS Degree is required.

PLAN B: Please consult with a counselor about specific courses needed or see the college catalog "Graduation Requirements" section. Plan B is not designed for transfer to a four-year college.

- 3 Units English Composition
- 3 Units Communication/Analytical Thinking
- 3 Units Natural Sciences
- 3 Units Humanities
- 3 Units Social/Behavioral Sciences (including American History & Governments)
- 3-4 Units Health/Physical Education
- 3-5 Units Math Competency

**HUMAN SERVICES
GENERALISTS OPTION (3-Year Plan)
Associate of Arts Degree
Career Program**

First Semester

Psychology 1	3
Psychology 43	3
*Physical Education	

Second Semester

Psychology 14	3
Psychology 41	3
Psychology 81	3
*Humanities Requirement	

Third Semester

Psychology 13	3
*Science Requirement	

Fourth Semester

Psychology 3	3
Psychology 82	3
*American Institutions Requirement	

Fifth Semester

Psychology 44	3
Psychology 83	3

Sixth Semester

Psychology 2	3
Psychology 45	3

Total Units36

* American Institutions Requirement Elective

Students must meet the mathematics competency requirements for the Associate of Arts degree.

Recommended electives: Psychology 64, Psychology 52, Psychology 18 or Psychology 66.

To complete general education requirements in this area of study, Plan B for the AA/AS Degree is required.
PLAN B: Please consult with a counselor about specific courses needed or see the college catalog "Graduation Requirements" section. Plan B is not designed for transfer to a four-year college.

3 Units	English Composition
3 Units	Communication/Analytical Thinking
3 Units	Natural Sciences
3 Units	Humanities
3 Units	Social/Behavioral Sciences (including American History & Governments)
3-4 Units	Health/Physical Education
3-5 Units	Math Competency

DRUG/ALCOHOL STUDIES OPTION)
(2-Year Plan)
Associate of Arts Degree
Career Program**

First Semester

Psychology 1	3
Psychology 43	3
Psychology 64	3

Second Semester

Psychology 14	3
Psychology 44	3
Psychology 65	3
Psychology 84	3
*Humanities Requirement	

Third Semester

Psychology 3	3
Psychology 67	3
Psychology 85	3
*American Institutions Requirement	

Fourth Semester

Psychology 2	3
Psychology 45	3
Psychology 63	3
Psychology 86	3
*Physical Education	
Total Units	42

* American Institutions Requirement Elective

Students must meet the mathematics competency requirements for the Associate of Arts degree.

Recommended electives: Psychology 64, Psychology 52, Psychology 18 or Psychology 66.

To complete general education requirements in this area of study, Plan B for the AA/AS Degree is required.
PLAN B: Please consult with a counselor about specific courses needed or see the college catalog "Graduation Requirements" section. Plan B is not designed for transfer to a four-year college.

3 Units	English Composition
3 Units	Communication/Analytical Thinking
3 Units	Natural Sciences
3 Units	Humanities
3 Units	Social/Behavioral Sciences (including American History & Governments)
3-4 Units	Health/Physical Education
3-5 Units	Math Competency

**DRUG/ALCOHOL STUDIES OPTION
(3-Year Plan)
Associate of Arts Degree
Career Program**

First Semester

Psychology 1	3
Psychology 43	3
Psychology 64	3

Second Semester

Psychology 65	3
Psychology 84	3

Third Semester

Psychology 14	3
Psychology 85	3
Psychology 67	3
*Humanities Requirement	

Fourth Semester

Psychology 44	3
Psychology 63	3
Psychology 86	3

Fifth Semester

Psychology 23
 Psychology 33
 *American Institutions Requirement3

Sixth Semester

Psychology 453
 *Physical Education

Total Units45

- * See notes under Two Year Course Plan above.
- ** This curriculum is accredited by the California Association of Alcohol and Drug Educators and meets the educational requirements for certification by the California Association of Alcohol and Drug Addiction Counselors.

To complete general education requirements in this area of study, Plan B for the AA/AS Degree is required.
 PLAN B: Please consult with a counselor about specific courses needed or see the college catalog "Graduation Requirements" section. Plan B is not designed for transfer to a four-year college.

- 3 Units English Composition
- 3 Units Communication/Analytical Thinking
- 3 Units Natural Sciences
- 3 Units Humanities
- 3 Units Social/Behavioral Sciences (including American History & Governments)
- 3-4 Units Health/Physical Education
- 3-5 Units Math Competency

CERTIFICATE PROGRAMS

HUMAN SERVICES

A certificate in Human Services will be issued by the Psychology Department upon successful completion of the following courses. A satisfactory grade of or better is required in all course work.

Please consult Associate of Arts Curriculum for sequencing of courses.

OPTION 1:

HUMAN SERVICES GENERALISTS Certificate

Psychology 13
 Psychology 33
 Psychology 133
 Psychology 143
 Psychology 273
 Psychology 433
 Psychology 443
 Psychology3
 Psychology 813
 Psychology 823
 Psychology 833
 English 28 or 101.....3
 Speech Communication 101,
 or Psychology 60, or Psychology 643

Total Units40

OPTION 2:

HUMAN SERVICES DRUG/ALCOHOL STUDIES Certificate

Psychology 13
 Psychology 33
 Psychology 143
 Psychology 271
 Psychology 433

Psychology 443
 Psychology 453
 Psychology 633
 Psychology 643
 Psychology 653
 Psychology 673
 Psychology 843
 Psychology 853
 Psychology 863
 English 28 or 101.....3

Total Units43

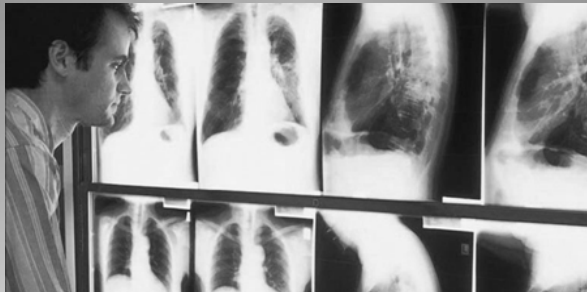

RADIOLOGIC TECHNOLOGY

Chair: John Radtke
(323) 953-4000 ext. 2943 • RT
www.lacitycollege.edu/academic/departments/radtech/index.html

PROGRAMS OFFERED Associate of Science: Radiological Technology

DEGREE PROGRAM
RADIOLOGIC TECHNOLOGY Associate of Science Degree Career Program

Radiologic Technology is a health care profession whose practitioners work in hospitals, clinics, free standing imaging centers, and private offices. The Radiologic Technologist (Radiographer) is a member of the health care team who works directly with the patient and the physician performing a wide variety of diagnostic x ray procedures. The Radiographer must be proficient in the knowledge of radiographic exposure, anatomy, patient positioning, the operation of specialized equipment, and in the care and management of the patient. The rapid expansion of medical diagnostic imaging has greatly increased the diversity and utility of medical diagnosis. A career in Radiologic Technology offers vast opportunities for advancement.

The Radiologic Technology curriculum is accredited by the Joint Review Committee on Education in Radiologic Technology (JRCERT) and the State of California, Department of Health Services. The clinical educational centers are accredited by the Joint Commission for the Accreditation of Health Care Organizations (JCAHO). Los Angeles City College is accredited by the Western Association of Schools and Colleges.

Students who complete the curriculum, including the clinical education requirements, will be eligible to take the certification examinations prepared by the American Registry of Radiologic Technologists and the State of California, Department of Health Services, Radiologic Health Branch. An advisory committee, composed of Radiologists, Radiologic Technologists, Radiology Administrators, Clinical Instructors and Student Technologists, cooperates with the College faculty and administrators in continuous curriculum development, evaluation, and revision.

Admission to the Program

Admission to the Radiologic Technology program is based upon completion of the following:

- The completion of the prerequisites with a satisfactory grade.
- An application form, to be submitted to the program director.
- The college accepts a limited number of students into the program, which is based on availability of clinical sites. Should the number of qualified applicants exceed the number of available openings, a simple lottery will be implemented.
- Official transcripts of all college courses attempted must be submitted.

Applicants must meet certain physical health requirements. A physical examination must be performed by a licensed physician to determine physical and mental fitness of the student. The program director is authorized to require records of such examinations be released to the college. Such records may be used only to determine fitness for the program, and except for such use, the confidentiality of such records shall be maintained. Students must be free from communicable diseases, infection, psychological disorders, and other conditions that prevent the successful performance of the responsibilities and tasks required in the program. Any health condition described above which is developed by the student after admission to the program may be considered sufficient cause for suspension from the program.

Desirable Abilities & Skills

The Joint Review Committee on Education in Radiologic Technology (JRCERT) our accrediting body requires student proficiency in the application of technical knowledge, operation of specialized equipment in a competent and safe manner, and the ability to provide physical care and emotional support to patients during radiographic procedures. Therefore, in order to be admitted to the program, or to be retained in the program after admission, all applicants should possess:

- Visual acuity, such as needed in the accurate preparation and administration of contrast media and for the observation necessary for patient assessment, care and management.
- Auditory perception to receive verbal communication from patients needing assistance and from members of the health care team.
- Communication skills (speech, reading, writing) to interact effectively and sensitively with patients in order to elicit information; describe changes in patient condition; assess non verbal communications; and be able to effectively and efficiently transmit information to patients, fellow students, faculty, staff and all members of the health care team.
- Gross and fine motor coordination to carry out diagnostic rocedures including reaching, lifting, and moving radiographic equipment. Applicants should be able to execute motor movements reasonably required to provide general and emergency care to patients.
- Intellectual ability to be able to measure, calculate, reason, analyze and evaluate as required for direct patient care. The applicant must be able to comprehend three dimensional and spatial relationships.
- Emotional stability to enable use of intellectual abilities, exercise good judgment, promptly complete all responsibilities attendant to care of the patients.
- Social attributes to allow the development of mature, sensitive and effective relationships with patients, faculty, co-workers, and administrators.

The "Technical Standards for Admission" have been established as a guidance tool for use in realistically informing the student of minimum standards needed to satisfactorily function in the Program and ultimately in the profession. The assessment of applicant compliance to these Standards will be accomplished in the following manner:

1. Faculty counseling to determine applicant goals and expectations.
2. A physical examination performed by a licensed physician.

Applicants who may be deficient in one or more of the areas mentioned above should contact the Program Director. Serious consideration will be given to applicants who are deficient in any of these categories, providing the deficiency can be remedied with reasonable accommodation.

Required Courses

The total number of students accepted into the program is determined by the number of available clinical education positions. Courses outlined below are necessary for completion of the program, and are applied toward requirements for the Associate in Science degree with a major in Radiologic Technology. Students are advised by department faculty to determine the specific sequence in which the following courses must be taken.

Prerequisite courses for entrance into the Radiologic Technology Program are: Anatomy 1, English 101 or 28 and 67, Mathematics 115 or higher, and Physiology 1, Radiologic Technology 100, 101, and 102.

Note: Class scheduling restricts the completion of this program to the day courses.

Radiologic Technology 103.....	4
Radiologic Technology 104.....	4
Radiologic Technology 105.....	3
Radiologic Technology 106.....	3
Radiologic Technology 107.....	3
Radiologic Technology 110.....	2
Radiologic Technology 140	3

CLINICAL EXPERIENCE

Radiologic Technology 160.....	4
Radiologic Technology 180.....	12
(Summer Session)	
Radiologic Technology 180.....	24
(Fall and Spring)	

Total Units 62

To complete general education requirements in this area of study, Plan B for the AA/AS Degree is required.
 PLAN B: Please consult with a counselor about specific courses needed or see the college catalog "Graduation Requirements" section. Plan B is not designed for transfer to a four-year college.
 3 Units English Composition
 3 Units Communication/Analytical Thinking
 3 Units Natural Sciences
 3 Units Humanities
 3 Units Social/Behavioral Sciences (including American History & Governments)
 3-4 Units Health/Physical Education
 3-5 Units Math Competency

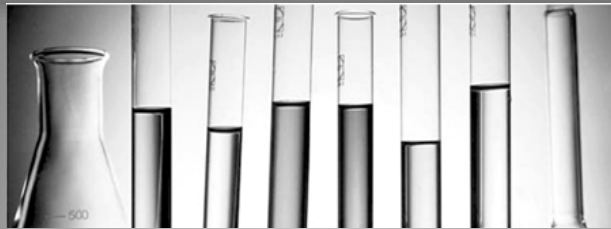

SCIENCE

Chairs: Greg Gonsalves, Life Science

(323) 953-4000 ext. 2796 • SCI 222E
www.lacitycollege.edu/academic/departments/lifesci/index.html

Jayesh Bhakta, Physics/Astronomy
(323) 953-4000 ext. 2924 • SCI 222D
www.lacitycollege.edu/academic/departments/physics/

John Freitas, Chemistry & Earth Sciences

(323) 953-4000 ext. 2600 • SCI 324B
www.lacitycollege.edu/academic/departments/chemistry/chem.html

PROGRAMS OFFERED

Associate of Science:

Chemistry
 Physics

Other Courses:

Anatomy	(Biology)
Astronomy	(Physics/Astronomy)
Biology	(Biology)
Chemistry	(Chemistry)
Earth Science	(Earth Sciences)
Environmental Science	(Earth Sciences)
Geography	(Earth Sciences)
Geology	(Earth Sciences)
Meteorology	(Earth Sciences)
Microbiology	(Biology)
Oceanography	(Earth Sciences)
Physical Science	(Physics/Astronomy)
Physiology	(Biology)

COURSES REFER TO THE FOLLOWING SECTION

Anatomy	BIOLOGY/ANATOMY
Astronomy	PHYSICS / ASTRONOMY
Biology.....	BIOLOGY
Chemistry	CHEMISTRY
Earth Science	EARTH SCIENCES
Environmental Science.....	EARTH SCIENCES
Geography	EARTH SCIENCES
Geology	EARTH SCIENCES
Meteorology.....	EARTH SCIENCES
Microbiology	BIOLOGY
Oceanography	EARTH SCIENCES
Physics	PHYSICS / ASTRONOMY
Physical Science	PHYSICAL SCIENCE
Physiology	BIOLOGY



SOCIAL SCIENCE

Chair: Wendel Eckford

(323) 953-4000 ext. 2561 • JH 200 D

www.lacitycollege.edu/academic/departments/socsci/index.html

PROGRAMS OFFERED

Associate of Arts:

Chicano Studies

POLITICAL SCIENCE Associate of Arts:

Modern Political Studies

Certificate:

African American Studies

Other Courses:

African American Studies
 Asian-American Studies
 Anthropology
 Economics
 History
 Political Science
 Sociology

DEGREE PROGRAM

CHICANO STUDIES

**Associate in Arts Degree
Transfer/Career Program**

This Associate in Arts degree is designed to provide an opportunity for the student to complete an undergraduate major in Chicano Studies.

First Semester

Chicano Studies 7	3
Chicano Studies 44.....	3
Psychology 1*	3
Spanish Language Course.....	5

Second Semester

Chicano Studies 8	3
Spanish Language	5

Third Semester

Chicano Studies 52.....	3
Spanish Language Course.....	5

Fourth Semester

General Education requirements

Total Units35

Suggested Electives: Economics 1; Political Science 1; Sociology 1

*Satisfies Social Science requirement.

Students may select "PLAN A" or "Plan B" general education requirements to graduate. PLAN

A: Please consult with a counselor about specific courses needed or see the college catalog "Graduation Requirements" section. Plan A is designed for transfer to a four-year college or university. However, requirements vary depending upon the individual institution. Please consult with a counselor for the specific requirements of the university you plan to attend.

- 3-6 Units English Composition
- 6-9 Units Communication/Analytical Thinking
- 3 Units Natural Sciences
- 3 Units Humanities
- 9 Units Social/Behavioral Sciences (including American History & Governments)
- 3-4 Units Health/Physical Education
- 3-5 Units Math Competency

(Math 115 or higher or passing score on Los Angeles Community College District Math competency exam)

PLAN B: Please consult with a counselor about specific courses needed or see the college catalog "Graduation Requirements" section. Plan B is not designed for transfer to a four-year college.

- 3 Units English Composition
- 3 Units Communication/Analytical Thinking
- 3 Units Natural Sciences
- 3 Units Humanities
- 3 Units Social/Behavioral Sciences (including American History & Governments)
- 3-4 Units Health/Physical Education
- 3-5 Units Math Competency

MODERN POLITICAL STUDIES

**Associate in Arts Degree
Transfer/Career Program**

The following curriculum designed by the Social Science Department may be used as undergraduate preparation for a major or minor in Modern Political Studies.

History 11.....	3
Political Science 1	3
Sociology 1 or 11	3
Political Science 2	3
Economics 1 or 2.....	3
Political Science 7	3

Students are advised to choose additional courses from those listed above in order to fulfill the Social and Behavioral Sciences section, (Area D) of the Plan A General Education described below.

NOTE: In addition to the major courses in "Social/Behavioral Sciences," you must complete 9 additional units in "Social/Behavioral Sciences" to satisfy Plan A requirements.

Students may select "PLAN A" or "Plan B" general education requirements to graduate. PLAN A: Please consult with a counselor about specific courses needed or see the college catalog "Graduation Requirements" section. Plan A is designed for transfer to a four-year college or university. However, requirements vary depending upon the individual institution. Please consult with a counselor for the specific requirements of the university you plan to attend.

- 3-6 Units English Composition
 - 6-9 Units Communication/Analytical Thinking
 - 3 Units Natural Sciences
 - 3 Units Humanities
 - 9 Units Social/Behavioral Sciences (including American History & Governments)
 - 3-4 Units Health/Physical Education
 - 3-5 Units Math Competency
- (Math 115 or higher or passing score on Los Angeles Community College District Math competency exam)

PLAN B: Please consult with a counselor about specific courses needed or see the college catalog

"Graduation Requirements" section. Plan B is not designed for transfer to a four-year college.

- 3 Units English Composition
- 3 Units Communication/Analytical Thinking
- 3 Units Natural Sciences
- 3 Units Humanities
- 3 Units Social/Behavioral Sciences (including American History & Governments)
- 3-4 Units Health/Physical Education
- 3-5 Units Math Competency

**Certificates:
AFRICAN AMERICAN STUDIES
Certificate:**

The Department will award the certificate in African American Studies upon application of the student with the Department Chair upon success completion of the courses listed below. All courses must be taken at LACC and completed with a satisfactory grade. Upon successful completion of the African American Studies Certificate, the students shall inquire knowledge about Africans in American and the African Diaspora: their cultures, their histories, and their politics. Students that earn the certificate are better positioned to apply for undergraduate transfer programs in African American, Africana and Black Studies.

Required

AFRO AM 4 or 5	3
AFRO AM 7	3
AFRO AM 20	3
AFRO AM 60	3
ANTHRO 102	3

Total15



SPEECH

Chair: Jeanne Dunphy
(323) 953-4000 ext. 2967 • CC187

PROGRAMS OFFERED
Courses Only - No Degree/Certificate

Oral communication is basic to all human activity- - to individual development, to interpersonal activity and to the functioning of all political, business, economic , cultural and social institutions. Speech communication examines communication behavior with the goal of understanding the structure, patterns, and effects of human communication and of facilitating a higher quality of communication effectiveness both for individuals and for society. It seeks to improve individual abilities for public speaking, handling informal conversations, creating and maintaining healthy relationships, interacting with individuals from other cultures, solving problems in groups and reaching sound decisions, managing the communication dynamics of an organization and becoming effective producers and consumers of informative, persuasive and artistic messages. The mission of this department is to effectively teach these skills.

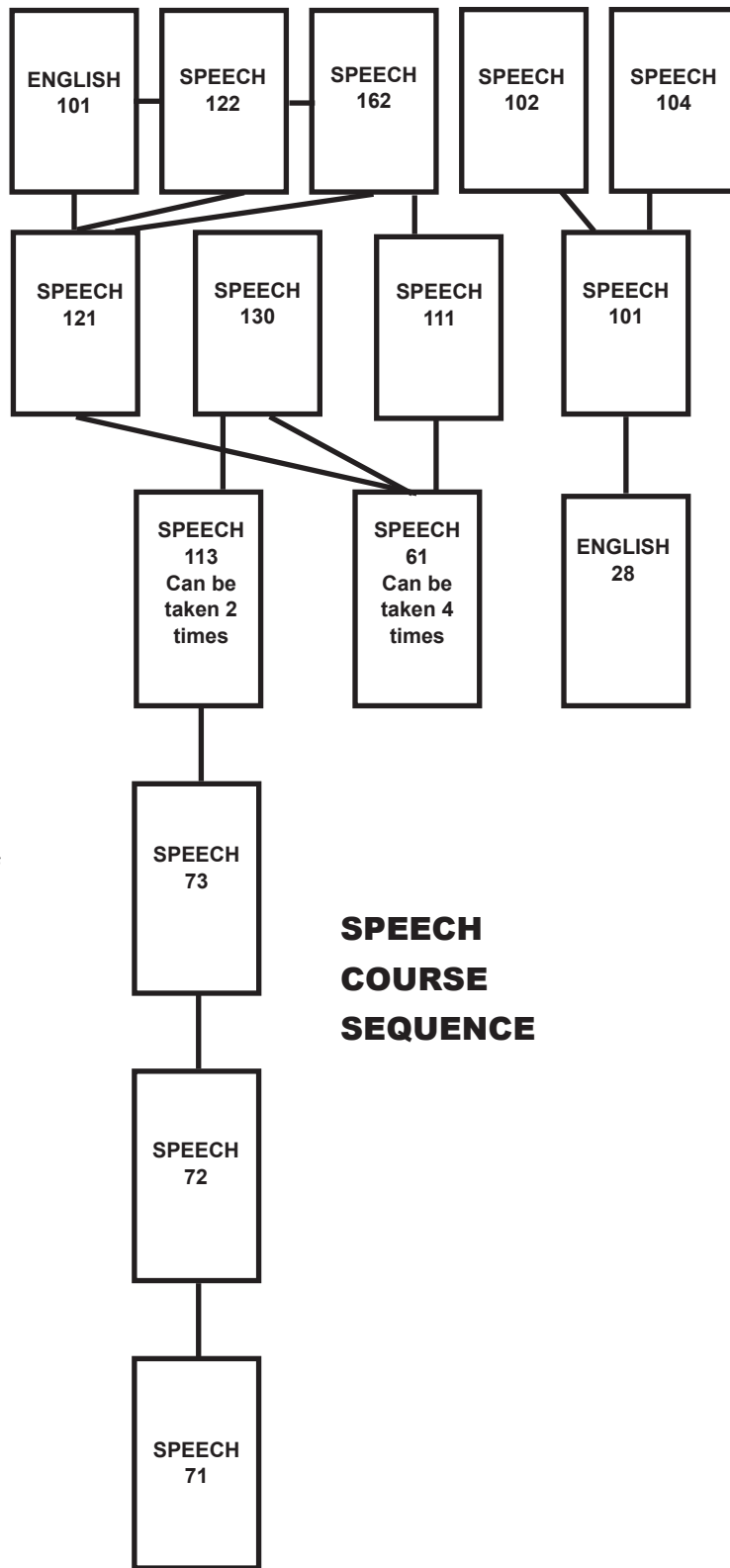



THEATER

Chair: Kevin Morrissey
(323) 953-4000 ext. 2992 • TA117

<http://theatreacademy.lacitycollege.edu/>

PROGRAMS OFFERED

Associate of Arts:
 Theater, General

Theatre Academy Vocational Certificates:
 Acting
 Advanced Acting Technical Theater
 Costuming

There are two types of programs offered for students interested in majoring in Theater:

- Associate of Arts Degree Program. This program is designed for students who wish to pursue an Associate of Arts degree in Theater and then transfer to an undergraduate university or college.
- Theatre Academy Professional Theatre Training Program.

This nationally recognized conservatory is a vocational skill certificated, professional theater training program for students specializing in acting, technical theater, and costuming who wish to move directly into the profession upon completion of their training.

Note that some courses offered may be offered every other semester, or less frequently. Students must receive a satisfactory grade in all Theater courses taken and have completed those courses within eight years to meet requirements.

DEGREE PROGRAM

GENERAL THEATER

(FOR NON-ACADEMY APPLICANTS)

Students studying in the Theater Department who are not part of the Theatre Academy fall into four categories:

1. Those who are satisfying their elective and/or humanities requirements for the Associate of Arts degree;
2. Those who are currently in the entertainment industry and are interested in focusing on a specific course that will further strengthen their

understanding of the craft and how it may apply to their profession;
 3. Those who are interested in receiving an Associate of Arts Degree and then transferring to an undergraduate university or college (PLAN A – See below);

THEATER

Associate of Arts Degree (Plan A)

Transfer Program

A student must satisfy an 18-unit minimum requirement in the Theater major plus general education units equalling an additional 60-64 units, minimum, in order to receive a transferable Associate of Arts degree in Theater. No specific combination of classes in Theater is required.

The following Theater program is strongly recommended for students interested in a transferable Associate of Arts Degree ("PLAN A").

First Semester

Theater 100	3
Theater 105	1
Theater 200	3

Second Semester

Theater 105	1
Theater 271	2
Theater 300	3

Third Semester

Theater 105	1
Theater 110	3
Theater 273	2
Theater 400	3

Fourth Semester

Theater 10	1
Theater 273	2
Theater 450	2
Total Units	25

Entrance requirements to the transferring university or college will vary depending upon the individual institution. Students need to consult with a counselor for the specific requirements of the university being considered.

To complete general education requirements in this area of study, Plan A for the AA/AS Degree is required.

PLAN A: Please consult with a counselor about specific courses needed or see the college catalog

"Graduation Requirements" section. Plan A is designed for transfer to a four-year college or university. However, requirements vary depending upon the individual institution. Please consult with a counselor for the specific requirements of the university you plan to attend.

3-6 Units	English Composition
6-9 Units	Communication/Analytical Thinking
3 Units	Natural Sciences
3 Units	Humanities
9 Units	Social/Behavioral Sciences (including American History & Governments)
3-4 Units	Health/Physical Education
3-5 Units	Math Competency

(Math 115 or higher or passing score on Los Angeles Community College District Math competency exam)

**CERTIFICATE PROGRAM
THEATRE ACADEMY**

**PROFESSIONAL THEATRE TRAINING PROGRAMS
FOR ACTORS, SCENIC TECHNICIANS,
AND COSTUMERS**

Vocational Certificate

Career Programs

Professional theater training is offered in four areas, or options, of concentration: Acting, Advanced Acting, Costuming, and Technical Theatre. The Theatre Academy at Los Angeles City College has firmly established itself as one of the most highly respected professional theater training institutions in the United States. Since its founding in 1929, the professional theatre training program of the Academy has been dedicated to developing the skills, crafts, and attitudes of students to prepare them for careers in the professional theater.

The Theatre Academy is dedicated to the training of talented, serious students who wish to pursue a career in the professional theatre. All prospective Academy students are required to apply for admission to the Theatre Academy (Theatre Production Office, Theatre Building 208. All candidates are required to audition and/or interview before being invited to train at the Academy. Those interested in training at the Academy should call the Theatre Production Office (323) 953-4000 ext. 2990 to set up an audition/interview.

The training that Theater Academy students receive is stimulating, broadening, exacting, and intense. A limited number of openings are available both Fall and Spring semester to those students who are highly motivated, aggressive, exceptionally talented, and responsible.

Information concerning audition/interview requirements is available in the Theatre Production Office of the Theatre Department. Any actor interested in pursuing training at the Theatre Academy must exhibit competence in spoken English, relatively free of dialects and regional accents, so that faulty understanding or articulation does not become a hindrance in the training.

All prospective Acting majors must consult with a member of the faculty before auditioning. Prospective Technical Theatre and Costume majors must consult with a faculty member in the appropriate area of interest within the Academy.

BLOCK SCHEDULING: The Theatre Academy is a full-time professional theatre conservatory that schedules classes in a “block” configuration; that is, students are given a specific and required full-time load of courses that are to be taken each semester. Students are not to vary the courses in each semester’s block schedule without approval of the department. When time permits, students are welcome to take other coursework outside the Academy class structure.

THEATRE ACADEMY OPTION I: ACTING

Vocational Certificate

Career Program

This two-year program is a full-time exploration of the skills necessary to compete in theatre, television, film, and other aspects of the entertainment industry. Guided by a critically acclaimed faculty with a vast range of experience in the industry, the students are provided fundamental skill understanding in acting, movement, voice, speech, character analysis, dialects, and production. Upon satisfactory completion of the program, the students will have developed a respect and appreciation for all aspects of theatre, along with the ability to create a character on stage and to sustain a performance in front of an audience.

First Semester

Theater 100 3
 Theater 1
 Theater 242 3
 Theater 270 3
 Theater 300 3
 Theater 345 2
 Theater 346 0
 Music 400 1

Second Semester

Theater 105 1
 Theater 240 3
 Theater 242 3
 Theater 272 2
 Theater 345 2
 Theater 346 0
 Theater 450 2

Third Semester

Theater 105 1
 Theater 232 2
 Theater 242 3
 Theater 243 (taken in either the third or fourth semester) 2
 Theater 274 3
 Theater 277 3
 Theater 294 2
 Theater 295 0
 Theater 110 (taken in either the third or fourth semester) 3

Fourth Semester

Theater 105 1
 Theater 232 2
 Theater 24 3
 Theater 243 (taken in either the third or fourth semester) 2
 Theater 262 2
 Theater 274 3
 Theater 277 3
 Theater 294 2
 Theater 295 0
 Theater 110 (taken in either the third or fourth semester) 3

Total Units 65

Some students may be advised to take additional prerequisites or co-requisite courses beyond those required to ensure success in the program. Others may be excused from specific courses above based on previous training and/or experience. Any other changes than those stated above are made with the advice and consent of the Theatre Academy faculty.

THEATRE ACADEMY OPTION II – ADVANCED ACTING

Vocational Certificate

Career Program

After successfully completing two years of professional actor training at the Theatre Academy, a select number of students are invited to a third year of specialized training where they receive advanced coursework in theatre orientation, directing, acting for the camera, rehearsal and performance, scene study, and work in classical acting. Students who complete this special third year of training are fully prepared to enter the acting field a step above many professional actors in the industry today. Audition and cold reading techniques, resume preparation and career marketing are only a few of the skills provided that will better equip the Academy graduate to work in the highly competitive fields of theatre, film, and television.

Fifth Semester

Theater 1851
 Theater 2052
 Theater 2253
 Theater 2322
 Theater 2753
 Theater 2763
 Theater 2942
 Theater 2950

Sixth Semester

Theater 1851
 Theater 2052
 Theater 225 (taken in Fall semester).....2
 Theater 2322
 Theater 2622
 Theater 2753
 Theater 2763
 Theater 2942
 Theater 2950

Total Units31

THEATRE ACADEMY OPTION III – COSTUMING

Vocational Certificate

Career Program

The Theatre Academy's program in Theatrical Costuming trains costumers and designers through a broad-based theatre curriculum with continual reference to the requirements and differences of television, video, and film costuming. The hands-on curriculum guides the student through methods of costume construction, procedures for handling theatrical wardrobe and organizational techniques, analyzing scripts from a costume perspective, dealing with costuming emergencies, and understanding Director/Designer relationships. This hands-on program stresses shop discipline, organization, maintenance, and procedures. The final two semesters of study focus on the student's individual interests and talents, including the development of a portfolio, the design of an Academy production, or internship at one of the Los Angeles theatres.

First Semester

Theater3
 Theater 1051
 Theater 4252
 Theater 4260
 Art 1013

One of the following five

Theater 4003
 Theater 4113
 Theater 4133
 Theater 4153
 Theater 4163

Second Semester

Theater 1051
 Theater 4252
 Theater 4260
 Art 5013

Two of the following five

Theater 4003
 Theater 4113
 Theater 4133
 Theater 4153
 Theater 4163

Third Semester

Theater 1051
 Theater 2003
 Theater 4252
 Theater 4260
 Art 2013

Two of the following five

Theater 4003
 Theater 4113
 Theater 4133
 Theater 4153
 Theater 4163

Fourth Semester

Theater 1051
 Theater 1103
 Theater 3003
 Theater 4252
 Theater 4260

One of the following five

Theater 4003
 Theater 4113
 Theater 4133
 Theater 4153
 Theater 4163

Total Units 54

Students are required to take Computer Science Information Technology 101 or Computer Technology 1, or be able to demonstrate computer proficiency to the satisfaction of the Costuming faculty.

Suggested Electives: Students qualified to take more than the prescribed units should take CAOT 1, 2; Art 202.

THEATRE ACADEMY OPTION IV – TECHNICAL THEATRE

Vocational Certificate

Career Program

The Technical Theatre Training program graduates highly trained and specialized scenic technicians who have learned a sound working knowledge of their craft and a respect for the skills and technologies associated with their chosen profession. The Technical Theatre Training program at LACC is one of the most unique hands-on programs of its kind in the country, with faculty working alongside students who are specifically interested in the disciplines and craft related to the stage technician. The cutting edge technologies being taught on state-of-the-art equipment are some of the most advanced in the theater training industry. The curriculum combines classroom study with the intense hands-on experience associated with the Academy's rigorous play production schedule.

First Semester

Theater 1003
 Theater 1051
 Theater 3023
 Theater 3253
 Theater 3352
 Theater 3360

One of the following four

Theater 3113
 Theater 3133
 Theater 3143
 Theater 3153

Second Semester

Theater 105 1
 Theater 325 3
 Theater 335 2
 Theater 336 0
 CAOT 60 3

One of the following four

Theater 311 3
 Theater 313 3
 Theater 314 3
 Theater 315 3

Third Semester

Theater 105 1
 Theater 200 3
 Theater 325 3
 Theater 335 2
 Theater 336 0

One of the following four

Theater 311 3
 Theater 313 3
 Theater 314 3
 Theater 315 3

Fourth Semester

Theater 105 1
 Theater 110 3
 Theater 185 1
 Theater 335 2
 Theater 336 0

One of the following four

Theater 311 3
 Theater 313 3
 Theater 314 3
 Theater 315 3

Total Units 49

Students are required to take Theater 200 and Computer Science 101 or Computer Technology 1, or be able to demonstrate computer proficiency to the satisfaction of the Scenic Technologies faculty. These courses must be taken between the Second and Fourth semesters.

Suggested Electives: Students qualified to take more than the prescribed units should take Theater 105; Art 101, 102, 209, 501.

THEATRE ACADEMY SKILL CERTIFICATE – LEVEL 1

Los Angeles City College has provided quality hands-on professional theatre training, technology, and production experience unrivaled by larger universities and performing arts academies. The Theatre Academy provides each student with the principles and techniques, discipline, organization, and dedication to training required for success in the entertainment industry. All areas of the Academy – acting, technical theatre, and costuming – are showcased each year in six to eight professional level productions. Intensive production experience is complemented by our location just minutes from Hollywood, “the entertainment capital of the world.”

PROFESSIONAL ACTOR TRAINING – LEVEL 1

Skill Certificate

The training introduces the student to acting fundamentals through specific movement and vocal techniques, character analysis, observation exercises, and scene study. The ultimate goal is to develop a firm foundation in basic acting skills and a strong respect and appreciation for all aspects of the theater. All training is geared toward preparing students for careers in acting and related industries.

Theater 100 3
 Theater 242 3
 Theater 270 3
 Theater 300 3
 Theater 345 2
 Theater 346 0
Total Units 14

PROFESSIONAL TECHNICAL THEATER – LEVEL 1

Skill Certificate

Basic level training in equipment, procedures, principles, and techniques used in play production, construction, painting, lighting, properties, manipulation of stage scenery, special effects, and organization of stage activity. All training is geared towards preparing students for careers in technical theater and related industries.

Theater 100 3
 Theater 302 3
 Theater 325 3
 Theater 335 2
 Theater 336 0

One of the following four

Theater 311 3
 Theater 313 3
 Theater 314 3
 Theater 315 3
Total Units 14

PROFESSIONAL COSTUMING DESIGN – LEVEL 1

Skill Certificate

Level 1 of the Professional Costuming program emphasizes, historic costume, costume design, wardrobing, drawing, costume shop discipline and organization, sewing and stagecraft. All training is geared towards preparing students for careers in costuming and related industries.

Theater 105 1
 Theater 425 2
 Theater 426 0
 Art 201 3

One of the following two:

Theater 300 3
 Theater 200 3

One of the following five

Theater 400 3
 Theater 411 3
 Theater 413 3
 Theater 415 3
 Theater 416 3

Total Units 15



WORKFORCE DEVELOPMENT READINESS ACADEMY

Dean: Alex Vaughan
(323) 953-4000 ext. 2596 • AD209

<http://workforce.lacitycollege.edu/>

PROGRAMS OFFERED

The Los Angeles City College (LACC) Workforce Readiness Academy prepares limited English proficient, economically disadvantaged, and other non-traditional college students to attain the essential knowledge, skills and abilities to successfully acquire and retain employment, and to effectively explore, plan and establish career ladder pathways leading growth opportunities in high demand occupations.

The focus of the Academy model is to designate participation in workforce education programs as the first step in the career ladder of success towards attaining economic self-sufficiency, with subsequent career ladder progression to credit, vocational education skills certificates, certificates, and associate degree programs.

Academy education and training programs encompass over 20 non-credit Skills Certificates of Competency and Completion, and over 49 courses in Basic Education and Computing skills, English as a Second Language (ESL), Vocational ESL, Workforce Literacy and Job Readiness skills, and associated Short-Term Vocational Training for high demand jobs in high growth industries such as the healthcare, child development, hospitality and retail sectors. Other high demand Academy programs include Citizenship Services and Entrepreneurship skills training.

All non-credit courses and Certificate programs are available FREE to all program participants! Take advantage of these opportunities to advance in your career now, and Welcome to Los Angeles City College... From the Staff of the Workforce Readiness Academy Also see the Citizenship/English Literacy section earlier in this catalog.

SKILLS CERTIFICATE PROGRAM

CERTIFICATES OF

COMPLETION/COMPETENCY:

WORKFORCE	LITERACY	SKILLS
Certificate of Completion		
Blueprint for Workplace Success.....		36
Blueprint for Customer Service.....		18
30 Ways to Shine as a New Employee		6
Review of Basic Math.....		36
Review of Basic English		36
Workplace Computing for Limited English Populations		54
Vocational English as a Second Language A.....		54
TOTAL LECTURE HOURS.....		240

WORKPLACE BASIC SKILLS

Certificate of Completion

Review of Basic Math.....	36
Review of Basic English	36
Workplace Computing for Limited English Populations	54
TOTAL LECTURE HOURS.....	126

JOB READINESS SKILLS

Certificate of Completion

Blueprint for Workplace Success.....	36
30 Ways to Shine as a New Employee	6
Job Club	7
Blueprint for Customer Service.....	18
TOTAL LECTURE HOURS.....	67

ACADEMIC PREPARATION SKILLS

Certificate of Completion

Review of Basic Math.....	36
Review of Basic English	36
Workplace Computing for LEP	54
TOTAL LECTURE HOURS.....	126

CAREER DISCOVERY SKILLS

Certificate of Completion

Blueprint for Workplace Success.....	36
Job Club	7
TOTAL LECTURE HOURS.....	43

IN-HOME SUPPORTIVE SERVICES SKILLS

Certificate of Competency

VESL for Home Health Aide.....	18
In-Home Supportive Services (IHSS) Provider	90
TOTAL LECTURE HOURS.....	108

RETAIL SALES AND CUSTOMER SERVICE SKILLS

Certificate of Competency

Customer Service Smarts: Going the Extra Mile.....	6
Strategies in Meeting Your Customer Needs.....	8
Strategies in Building a Continuous Relationship.....	6
Get to Know Your Customer.....	6
TOTAL LECTURE HOURS.....	26

RETAILING SMARTS SKILLS

Certificate of Competency

Building Sales	7
Closing the Sale	4
Completing the Sales Transaction.....	5
Explaining Features and Benefits.....	7
Customer Service Smarts: Going the Extra Mile.....	6
Strategies in Meeting Your Customer Needs.....	8
Strategies in Building a Continuous Relationship.....	6
Get to Know Your Customer.....	6
TOTAL LECTURE HOURS.....	49

RETAIL SUPERVISORY AND MANAGEMENT***Certificate of Comperency***

Customer Service Smarts: Going the Extra Mile	6
Strategies in Meeting Your Customer Needs	8
Strategies in Building a Continuous Relationship	6
Get to Know Your Customer	6
TOTAL LECTURE HOURS	26

ENTREPRENEURSHIP SKILLS***Certificate of Comperency***

Young Entrepreneur Training Program	36
Blueprint for Customer Service.....	18
TOTAL LECTURE HOURS	54

HOSPITALITY SKILLS***Certificate of Comperency***

Banquet Server Skills Training	6
Front Desk Representative – Making a Good Impression.....	6
Laundry Attendant Skills Training	6
Public Space Cleaner Skills Training.....	6
Restaurant Server Skills Training	6
Kitchen Steward Skills Training	6
Maintenance Employee Skills Training.....	6
Reservationists Skills Training.....	6
Guestroom Attendant Skills Training	6
TOTAL LECTURE HOURS	54

Beginning English as a Second Language Skills***Certificate of Completion***

Courses	Lecture Hours
English as a Second Language – Beginning I	54
English as a Second Language – Beginning II	54
English as a Second Language – 0.....	54
TOTAL LECTURE HOURS	162

Intermediate English as a Second Language Skills***Certificate of Completion***

Courses	Lecture Hours
English as a Second Language – 1.....	216
English as a Second Language – 2.....	216
TOTAL LECTURE HOURS	432

TRANSITIONAL ENGLISH AS A SECOND LANGUAGE***Skills Certificate of Completion***

Courses	Lecture Hours
English as a Second Language – 2	216
English as a Second Language – 3	216
TOTAL LECTURE HOURS	432

ENGLISH AS A SECOND LANGUAGE SKILLS***Certificate of Completion***

Courses	Lecture Hours
English as a Second Language – 0	216
English as a Second Language – 1	216
English as a Second Language – 2	216
English as a Second Language – 3	216
TOTAL LECTURE HOURS:	864

CITIZENSHIP SKILLS***Certificate of Completion***

Courses	Lecture Hours
English Literacy and Civics 0	108
English Literacy and Civics 1	108
English Literacy and Civics 2	108
TOTAL LECTURE HOURS:	324

ENGLISH AS A SECOND LANGUAGE-CIVICS I SKILLS***Certificate of Completion***

Courses	Lecture Hours
English Literacy and Civics 0	108
English Literacy and Civics 1	108
English Literacy and Civics 2	108
ESL and Civics 1	54
ESL and Civics 3	54
TOTAL LECTURE HOURS:	432

ENGLISH AS A SECOND LANGUAGE-CIVICS II SKILLS***Certificate of Completion***

Courses	Lecture Hours
ESL and Civics 4	54
ESL and Civics 5	54
ESL and Civics 6	54
TOTAL LECTURE HOURS	162

VOCATIONAL ENGLISH AS A SECOND LANGUAGE***Skills Certificate of Completion***

Courses	Lecture Hours
Vocational English as a Second Language A	54
Vocational English as a Second Language B	54
Vocational English as a Second Language C	54
TOTAL LECTURE HOURS	162

VOCATIONAL ENGLISH FOR CAREERS***Certificate of Completion***

Courses	Lecture Hours
Vocational English as a Second Language A	54
Vocational English as a Second Language B	54
Vocational English as a Second Language C	54
Blueprint for Workplace Success	36
TOTAL LECTURE HOURS	198

VOCATIONAL ENGLISH FOR CHILD DEVELOPMENT***Skills Certificate of Completion***

Courses	Lecture Hours
Blueprint for Workplace Success	36
VESL for Child Development 1: Specialized Vocabulary in Development	
Theories	36
TOTAL LECTURE HOURS	72

VOCATIONAL ENGLISH FOR OFFICE PROCEDURES***Certificate of Completion***

Courses	Lecture Hours
Blueprint for Workplace Success	36
VESL: Reading for Office Skills	18
TOTAL LECTURE HOURS:	54

VOCATIONAL ENGLISH FOR HEALTH OCCUPATIONS***Skills Certificate of Completion***

Courses	Lecture Hours
Blueprint for Workplace Success	36
VESL for Home Health Aide	18
VESL for Health Careers	36
TOTAL LECTURE HOURS	90

Workforce Readiness Academy

ALL COURSES ARE ALSO OFFERED ON A "STAND-ALONE" BASIS

Nelines Colon-Paladini
Coordinator of Non-Credit Programs
(323) 953-4000 ext. 2230

Devon M. Werble
Instructional Director; Faculty
Curriculum Development
(323) 953-4000 ext. 2236

The LACC Workforce Readiness Academy was voted "Best Workforce Development Program" at the LA Community College District's Excellence in Workforce Development Awards, held in May 2008. The District's eighth annual event also honored the program with a first place trophy in the category "Successful Encouragement of Special Populations." This academy is a vital part of LACC and its courses are taught in the City College at Wilshire building, 3020 Wilshire Blvd. The program is focused on non-credit workforce education and enables students to enter various career ladder pathways.



ACCOUNTING

ACCOUNTING 1 INTRODUCTORY ACCOUNTING I 5 UNITS - (UC:CSU)

Lecture 5 hours

Accounting 1 is intended for transfer students. All others should consider taking Accounting 21 with Accounting 41.

Students learn fundamental accounting principles and concepts. Accounting 1 is intended for transfer students. (All other students should consider taking Accounting 21 with Accounting 41 and Accounting 22 with Accounting 42.) Includes analysis and recording of various business transactions in the journals and ledgers; preparation of basic financial statements of service and merchandising firms; detailed study of accounting for cash, receivables, inventory, plant assets including depreciation; intangible assets and amortization; payables payroll and related payroll taxes.

ACCOUNTING 2 INTRODUCTORY ACCOUNTING II 5 UNITS - (UC:CSU)

Lecture 5 hours

Prerequisite: Accounting 1 or 22 with a satisfactory grade or better.

Students continue learning fundamental accounting principles and concepts including the recording of transactions unique to partnerships and corporate forms of business. Students prepare cash flow statements, financial analysis and interpretation and introduction to basic cost accounting concepts and procedures. Basic fundamental understanding of issuing and investing in stocks and bonds.

ACCOUNTING 12 AUDITING 3 UNITS - (CSU)

Lecture 3 hours

Co-requisite: Accounting 4 with a satisfactory grade or better.

The principles of auditing and the steps to be followed in conducting an audit, preparation of audit working papers and audit reports, and solution of an audit case.

ACCOUNTING 15
TAX ACCOUNTING I
3 UNITS - (CSU)

Lecture 3 hours

Prerequisite: Accounting 1 with a satisfactory grade or better.
 Tax laws, accounting procedures required in the preparation of Federal and California State income tax returns for individuals. Can be utilized to meet the basic qualifications for registering as a tax preparer and the continuing education requirements of the California Tax Preparer Act.

ACCOUNTING 16 ARCHIVED
Tax Accounting II
3 UNITS - (CSU)

ACCOUNTING 17
Payroll Accounting
2 UNITS - (CSU)

Lecture 2 hours.

Advisory: English 28 and 67 or appropriate placement on college assessment.

Concerned with procedures and practices involved in a firm's payroll system, includes familiarizing students with current State and Federal laws with respect to computation of regular and overtime pay, withholding of payroll taxes, computation of employer's payroll taxes, and the preparation of payroll tax returns and reports.

ACCOUNTING 18
Computerized Payroll Accounting
3 UNITS - (A)

Lecture 4 hours; Laboratory 2 hours.

Prerequisite: Accounting 1 or Accounting 21 with a satisfactory grade or better.

Concerned with procedures and practices involved in a manual or automated payroll system. Includes familiarizing students with current state and federal laws affecting payroll, computation of payroll taxes and preparation of payroll tax returns.

ACCOUNTING 20
Managerial Accounting
3 UNITS - (CSU)

Lecture 3 hours.

Prerequisite: Accounting 2 with a satisfactory grade or better.

This course is designed to study accounting information for management which emphasizes profit and planning, cost-volume-profit decisions, the use of standard and flexible cost systems, cost reports, capital budgeting, managerial control, and performance evaluation.

ACCOUNTING 21
Bookkeeping and Accounting I
3 UNITS - (UC:CSU)

Lecture 3 hours.

Co-requisite: Accounting 41.

{Note: Accounting 21 students must also enroll in Accounting 41 at the same hour and with the same instructor as Accounting 21. Credit allowed for only Accounting 1 or the combination of Accounting 21 with 41 and 22 with 42.}

UC limit: Accounting 21 and 22 equal five units allowable.

Fundamentals of double-entry accounting; the accounting cycle; preparation of the trial balance, adjusting entries and three basic financial statements; use of controlling accounts; accounting for merchandise and cash transactions; special journals and periodic reporting.

ACCOUNTING 22
Bookkeeping and Accounting II
3 UNITS - (UC:CSU)

Lecture 3 hours

Prerequisite: Accounting 21 with satisfactory grades or better.
Co-requisite: Accounting 42

{Note: Accounting 22 students must enroll in Accounting 42 at the same hour and with the same instructor as Accounting 22.}

This class covers accounting for receivables, payable and bad debts, deferrals and accruals, merchandise inventories, plant and equipment, accounting for partnerships and corporations, Cash Flow statement, comparative financial statement analysis, and accounting for manufacturing enterprises.

ACCOUNTING 23
Record Keeping for Small BUSINESS
3 UNITS - (A)

Lecture 3 hours.

Prerequisite: Accounting 1 or Accounting 21 with satisfactory grades or better.

Quick Books class builds on knowledge and background gained from Accounting 21/41 and introductory computer skills. Introduces cash basis concept of accounting, and small business computerized accounting software using Quick books. Students will complete simulated accounting projects designed for different types of small business firms using both manual and automated systems.

ACCOUNTING 25
Accounting: Automated Accounting Methods and Procedures
3 UNITS - (A)

Lecture 3 hours.

Prerequisite: Accounting 1 or Accounting 21 with satisfactory grades or better.

Designed for hands-on experience with the micro computer in the accounting environment. Basic emphasis will be computerized accounting with special emphasis to maintenance of general ledger, accounts receivable, accounts payable, and payroll records. Also, the preparation of worksheets, financial statements, and payroll records.

ACCOUNTING 27
Accounting: Automated Accounting Methods and Procedures II
3 UNITS - (A)

Lecture 2 hours; Laboratory 2 hours.

Prerequisite: Accounting 1 or Accounting 21 with a satisfactory grade or better.

Computer applications in the preparation of special journals, payroll register, bank reconciliation, aging account receivable inventory costing and depreciation. Analysis reconciliation, aging accounts receivable, inventory costing and depreciation. Analysis of financial statements and preparation of a computerized practice set.

ACCOUNTING 31
Mathematics of Accounting
3 UNITS - (CSU)

Lecture 3 hours.

Advisory: English 28 and 67 or equivalent.

Review of mathematical fundamentals, followed by bank reconciliation, payroll computations, depreciation and allocation of overhead, trade and cash discounts, simple and compound interest computations, multiple payment plans, present value, sinking fund and amortization.

ACCOUNTING 41
Accounting: Laboratory for
ACCOUNTING 21
1 UNIT - (A)

Laboratory 2 hours.

Co-requisite: Accounting 21

{Note: Accounting 41 students must also enroll in Accounting 21 at the same hour and with the same instructor as Accounting 41}

Fundamentals of double- entry accounting; the accounting cycle; preparation of the trial balance; adjusting entries and three basic financial statements; use of controlling accounts; accounting for merchandising and cash transactions; special journals and periodic reporting.

ACCOUNTING 42
Laboratory For Accounting 22
1 UNIT - (A)

Laboratory 2 hours.

Prerequisite: Accounting 41 with a satisfactory grade or better.

Co-requisite: Accounting 22 which meets at the same hour.

Accounting 42 students must also enroll in Accounting 22, at the same hour and with the same instructor. This laboratory course is designed to reinforce the lecture and discussion in Accounting 22.

ACCOUNTING 55
Accounting: Accounting Computer Laboratory
1 UNIT - (A)

Laboratory 2 hours.

Prerequisite: Accounting 21 with a satisfactory grade or better.

Students learn to use the spreadsheet software "Microsoft Excel" for solving accounting problems and concepts being studied in other accounting class sections.

ACCOUNTING 185 DIRECTED STUDY —
1 UNITS (CSU)

Lecture 1 hour.

ACCOUNTING 285 DIRECTED STUDY —
2 UNITS (CSU)

Lecture 2 hours.

ACCOUNTING 385 DIRECTED STUDY —
3 UNITS (CSU)

Lecture 3 hours.

Conference 1 hour per unit.

Allows students to pursue Directed Study on a contract basis under the direction of a supervising instructor. Refer to the "Directed Study" section of this catalog for additional information.

Credit Limit: A maximum of 3 units in Directed Study may be taken for credit.

ADMINISTRATION OF JUSTICE

ADMINISTRATION OF JUSTICE 1
Introduction to Administration of Justice
3 UNITS - (UC:CSU)

Lecture 3 hours

Students learn the philosophy and history of law enforcement, overview of crime criminal justice problems, including community relations: Organization and jurisdiction of local, state, and federal law enforcement agencies. Students survey professional career opportunities; and qualifications required for entry into a career in Administration of Justice.

ADMINISTRATION OF JUSTICE 2
Concepts of Criminal Law
3 UNITS - (UC:CSU)

Lecture 3 hours.

The students learn the basic principles of the evolution of the English Common Law with emphasis on sections of the California Penal Code most frequently used by police officers.

ADMINISTRATION OF JUSTICE 3
Legal Aspects of Evidence
3 UNITS - (CSU)

Lecture 3 hours

Students learn the origin, development, philosophy and constitutional basis of evidence. Students also analyze the constitutional considerations of the rules governing the admissibility of evidence in court.

ADMINISTRATION OF JUSTICE 4
Principles and Procedures of the Justice System
3 UNITS - (CSU)

Lecture 3 hours.

The students cover the legal processes from pre-arrest through trial, sentencing & correctional procedures.

UC limit: One course from Administration of Justice 1, 4

ADMINISTRATION OF JUSTICE 5
Criminal Investigation
3 UNITS - (CSU)

Lecture 3 hours.

This course will cover the fundamentals of a criminal investigation. Topics include: Interviews and interrogations, evidence collection and analysis and case preparation for court.

ADMINISTRATION OF JUSTICE 6
Patrol Procedures
3 UNITS - (CSU)

Lecture 3 hours.

The students cover the history and development of patrol philosophy; planning for field activities to include functions of patrol, traffic and other preliminary investigative duties of the field officers.

ADMINISTRATION OF JUSTICE 8 ARCHIVED

Juvenile Procedures

3 UNITS - (CSU)

ADMINISTRATION OF JUSTICE 14
Report Writing for Law
Enforcement
3 UNITS - (CSU)

Lecture 3 hours.

This course concentrates on the study of written reports used by law enforcement agencies. Practice in organizing and presenting factual material with clarity, definiteness and conciseness is emphasized.

ADMINISTRATION OF JUSTICE 16
Recruitment Selection Process
3 UNITS - (CSU)

Lecture 3 hours.

The students receive an in-depth coverage of the selection process for employment in a law enforcement agency.

ADMINISTRATION OF JUSTICE 39
Probation and Parole
3 UNITS - (CSU)

Lecture 3 hours.

This course will concentrate on the background, structures and procedures of Probation and Parole including the juvenile and criminal court process. The relationship to law enforcement and corrections will be investigated.

ADMINISTRATION OF JUSTICE 53
Forensic Fingerprint Evidence
3 UNITS - (UC:CSU)

Lecture 3 hours.

Students locate, develop and lift fingerprints from crime scenes. These skills are a must for students interested in law enforcement as a police officer or evidence specialist or for private investigations.

ADMINISTRATION OF JUSTICE 60
Arrest, Search and Seizure
3 UNITS - (CSU)

Lecture 3 hours.

Students concentrate on their individual rights as it pertains to an officer searching and/or seizing property. Fourth Amendment rights regarding unreasonable search and seizure are discussed.

ADMINISTRATION OF JUSTICE 62
Fingerprint Classification
3 UNITS - (CSU)

Lecture 3 hours.

A practical course designed to cover the technical aspects of fingerprinting. Topics will include pattern interpretation, classification, taking and lifting of prints, and searching and filing procedures. Times will be devoted to laboratory work in the classroom.

ADMINISTRATION OF JUSTICE 67 ARCHIVED
 Community Relations I
 3 UNITS - (UC:CSU)

ADMINISTRATION OF JUSTICE 160
Police Organization and Administration
3 UNITS - (CSU)

Lecture 3 hours.

Students learn the effect of organizational structure and administrative procedure in relation to the implementation of police functions, assessment of processes of recruitment, career advancement, leadership, and administrative problems of staffing, supervision and morale.

ADMINISTRATION OF JUSTICE 180
Introduction to Forensics
3 UNITS - (CSU)

Lecture 3 hours.

This course concentrates on crime scene evidence. Forensic Science and collection techniques will be emphasized as well as the interpreting the evidence.

ADMINISTRATION OF JUSTICE 314
Forensic Psychology for Law Enforcement
1 UNIT - (A)

Lecture 1 hour.

Co-requisite: Psychology 38.

This area of forensic will primarily concentrate on the psychological aspect of the accused, the victim and the legal system. Special areas of interest include criminal profiling, lie detection, interrogation, jury selection, insanity, battered women syndrome and rape trauma syndrome.

ADMINISTRATION OF JUSTICE 379
Advanced Criminalistics -Forensics I
3 UNITS - (A)

Lecture 3 hours.

Advisory: Administration of Justice 180.

Students concentrate on three areas of forensics: Serology (blood/DNA), blood spatter analysis and trace evidence. Students use a "hands-on" approach to identify and collect this type of evidence and learn the techniques, used by crime-lab criminalists, to analyze evidence.

ADMINISTRATION OF JUSTICE 381
Law Enforcement Internship
3 UNITS - (A)

Lecture 1 hour; laboratory 8 hours.

The students provide voluntary service to a law enforcement agency of their choice to determine whether police work will be a career goal.

ADMINISTRATION OF JUSTICE 382
Introduction to the Firearms Training System
3 UNITS - (A)

Lecture 3 hours.

Students learn the legal ramifications in the use of deadly force by law enforcement personnel. Additionally, with the use of a computer simulation, students are placed in "real life" type situations and must determine to "shoot or don't shoot".

ADMINISTRATION OF JUSTICE 391
Firearms Evidence Analysis
3 UNITS - (A)

Lecture 3 hours.

Firearm analysis is a forensic course that examines all aspects of firearms - guns/rifles/shotguns, bullets, cartridges, and bullet comparisons. The student approaches firearm analysis from a criminalist point of view and uses a "hands-on" approach through practical exercises and microscope comparisons.

ADMINISTRATION OF JUSTICE 396
Traffic Collision Investigation
3 UNITS - (A)

Lecture 3 hours.

Advisories: English 28 and 67.

Students concentrate on investigating traffic collisions by identifying and interpreting forensic evidence as well as diagramming and measuring scenes. Students also learn how to understand vehicle and pedestrian dynamics (behaviors) normally associated after a collision.

ADMINISTRATION OF JUSTICE 413
Financial Crimes Investigations
3 UNITS - (A)

Lecture 3 hours.

Advisories: English 28 and 67.

Students concentrate on the criminal and civil investigation techniques in dealing with the highly technical field of financial crimes. Students analyze the following crimes: forgery, credit card fraud, financial scams, fake identification fraud, computer fraud, internet crimes and identification fraud (Social Security Number).

AFRICAN-AMERICAN STUDIES

AFRICAN-AMERICAN STUDIES 2 ARCHIVED
The African-American In Contemporary Urban Society
3 UNITS - (UC:CSU)

AFRICAN-AMERICAN STUDIES 4 The African-American in the History of the United States I

3 UNITS - (UC:CSU)

Advisory: English 28 and 67.

Note: Meets the Associate in Arts degree requirements in U.S. History, U.S. Constitution, and California State and Local Government. Students analyze historiographical issues in African American history and how black Americans were active agents in creating their own history. Emphasis on the African background of African Americans, the institution of slavery, the development of the African American community institutions, and African American participation in and impact on the Civil War and Reconstruction.

AFRICAN-AMERICAN STUDIES 5 The African-American in the History of the United States II

3 UNITS - (UC:CSU)

Lecture 3 hours.

Advisory: English 28 and 67.

Note: Meets the Associate in Arts degree requirements in U.S. History, U.S. Constitution, and California State and Local Government. Transfer Limit UC. Maximum credit one course from African Am Studies 5, Chicano Studies 8, and History 12 or 13.

Students analyze historiographical issues in African American history and how black Americans were active agents in creating their own history. Emphasis on ideas of black social thought, political protest and efforts to create social change from Reconstruction to the present.

AFRICAN-AMERICAN STUDIES 7 African-Americans and the Political System

3 UNITS - (UC:CSU)

Lecture 3 hours.

Advisory: English 28 and 67.

Students analyze the relationship of minority groups to American Politics with emphasis on African Americans in the political system. This course gives an in-depth study of the distribution of political power at the Federal and State levels, African American political thought, ranging from early 18th and 19th emigrationist sentiments to the nationalist exhortations of contemporary African American culture, including African American feminist and socialist thought.

AFRICAN-AMERICAN STUDIES 20 African-American Literature I

3 UNITS - (UC:CSU)

Lecture 3 hours.

Advisory: English 28 and 67.

Students survey African American writers, covering all types of literatures (slave narrative, poetry, novels, etc.) to develop a positive attitude towards reading and understanding the progression of American culture as interpreted by African American writers.

AFRICAN-AMERICAN STUDIES 21 ARCHIVED
African-American Literature II
3 UNITS - (UC:CSU)

AFRICAN-AMERICAN STUDIES 60 African-American Music

3 UNITS - (UC:CSU)

Lecture 3 hours.

A study of African-American Music and their influences on folk spirituals, gospels, concert music, opera, ballet, blues and jazz underscoring styles, characteristics, origin and contributions by African-American Artists.

Credit allowed Credit allowed for only one of African America 60 and Music 135.

AMERICAN SIGN LANGUAGE

AMERICAN SIGN LANGUAGE 1

American Sign Language I

4 UNITS - (UC:CSU)

Lecture 5 hours.

This is an introductory course designed to develop basic conversational skills using vocabulary and grammar of American Sign Language. Its emphasis is placed on receptive and comprehension skills. Incorporates vital aspects of the Deaf culture and community.

AMERICAN SIGN LANGUAGE 2

American Sign Language II

4 UNITS - (UC:CSU)

Lecture 4 hours. Laboratory 1 hour.

Prerequisite: American Sign Language I with a satisfactory grade or better.

This course completes the study of elementary vocabulary and grammar. Increased development of inflectional and non-manual behavior patterns. Incorporation of selected aspects of Deaf culture and community within receptive and expressive conversation.

AMERICAN SIGN LANGUAGE 3

American Sign Language III

4 UNITS - (UC:CSU)

Lecture 4 hours.

Prerequisite: American Sign Language 2 with a satisfactory grade.

Students continue to develop American Sign Language grammar, with special emphasis on idiomatic constructions. Conversational techniques are emphasized focusing on expressive skills, and expanded study of Deaf cultural issues.

AMERICAN SIGN LANGUAGE 30

Finger Spelling I

1 UNIT - (CSU)

Lecture 1 hour. Laboratory 1 hour.

Prerequisite: American Sign Language 1.

Develop skills in expressive and receptive use of American manual alphabet (finger spelling) and its use. Deals with specific individual problems and techniques for corrections. Overview of topics include: hand positioning, hand shapes, rhythm, fluency, spelling, and numbers; reception of finger spelled shapes, pattern and pauses/transitions.

AMERICAN SIGN LANGUAGE 31**Finger Spelling II
1 UNIT - (CSU)***Laboratory 2 hours.**Prerequisite: American Sign Language 30.*

Continue development of expressive and receptive Manual Alphabet skills. Emphasis on techniques to improve receptive skill. Attention given to expressive fluency and accuracy, including, the proper hand shape, clarity, speed, smoothness and correct English spelling.

AMERICAN SIGN LANGUAGE 40**Introduction to Deaf Culture
3 UNITS - (CSU: UC)***Lecture 3 hours.**Advisory: English 28 and 67.*

Students learn about historical, philosophical, educational, psychological and social aspects of the deaf and hard of hearing. Deaf culture and the social process affecting and influencing its members is emphasized.

ANATOMY**ANATOMY 1****Introduction to Human Anatomy
4 UNITS - (UC:CSU)***Lecture 3 hours. Laboratory 3 hours.**Advisory: Eligibility for English 28 and 67 or equivalent.*

In this basic course in human anatomy, lectures and demonstrations are given on human organs and organ systems. Each student dissects a mammal that is comparable in structure to the human body.

ANTHROPOLOGY**ANTHROPOLOGY 101
Human Biological Evolution
3 UNITS - (UC:CSU)***Lecture 3 hours.**Advisory: English 28 and 67 or equivalent.*

This course examines evolutionary theory, human genetics, classification, and introduction to primates, the hominid fossil record, classification, and modern human variation. Students will be able to underline the historical path to natural selection, describe the five factors of the evolutionary process, identify biological characteristics of primates, discuss features of primate behavior, diagram the origin of mankind through comparing skulls from the hominid fossil record, and interpret modern human variation.

**ANTHROPOLOGY 102
Human Ways of Life: Cultural ANTHROPOLOGY
3 UNITS - (UC:CSU)***Lecture 3 hours.**Advisory: English 28 and 67 or equivalent.*

This course establishes the four-field approach to anthropology while covering both anthropological theory and method. Conversations will adopt a holistic perspective to human culture and establish cultural relativism. The objectives of this course are (1) to employ a relative perspective in the appreciation of the world's cultural diversity, and (2) to apply case studies to describe this variation. The student examines communication, learning, subsistence, economics, family,

kinship, gender, ethnicity, politics, stratification, globalization, religion, expressive art, and cultural changes as these all affect our lives, through assigned readings from the text, lectures, discussions and ethnographic investigations, this course will equip you the student with a better understanding of cultural life ways, both past and present, in this time of globalization.

**ANTHROPOLOGY 103
Archaeology: Reconstructing the Human Past
3 UNITS - (UC:CSU)***Lecture 3 hours.**Advisory: English 28 and 67.*

This course is an exploration of the theories and methods of contemporary archaeology and offers a narrative on prehistory. Students will interpret the peopling of the planet, culture change, and the rise of civilization using the archaeological record. Students will construct a theory-rich research design that reflects current trends in contemporary archaeology.

**ANTHROPOLOGY 111
Laboratory in Human Biological Evolution
2 UNITS - (UC:CSU)***Lecture 1 hour. Laboratory 2 hours.**Co-requisite: Anthropology 101.*

This course introduces laboratory methods used to examine evolutionary theory, human genetics, classification, an introduction to primates, the hominid fossil record, and modern human variation. Students will use practical research modules to identify biological characteristics of primate using principles of classification, discuss features of primate locomotion, diagram the origin of mankind by employing the comparative morphology of skulls from the hominid fossil record, and use forensic techniques to interpret modern human variation. Students must complete Anthropology 101 or be currently enrolled.

ARABIC**ARABIC 1
Elementary Arabic I
5 UNITS - (UC:CSU)***Lecture 5 hours. Laboratory 1 hour.**Advisory: English 28 and 67*

Introduces the fundamentals of the Arabic pronunciation and grammar structure. The student receives practical material for simple conversation based on everyday experiences and basic facts on the geography, customs and culture of the Arabic speaking world.

**ARABIC 2
Elementary Arabic II
5 UNITS - (UC:CSU)***Lecture 5 hours. Laboratory 1 hour.**Prerequisite: Arabic 1 with a satisfactory grade or equivalent.**Advisory: English 28 and 67.*

Completes the elementary Arabic grammar, begins the reading and writing of more advanced elementary texts.

ARABIC 3 ARCHIVED

Intermediate Arabic I

5 UNITS - (UC:CSU)

ARCHITECTURE

ARCHITECTURE 110 **Introduction to Architecture** **1 UNIT - (UC:CSU)**

Lecture 2 hours.

An introductory course on architecture for all architectural and non-architectural students. The course will examine examples of great Architecture, study basic architectural theories, and explore the academic as well as the professional practice of Architecture. Emphasis will be placed on developing awareness, critical thinking and observation of the built environment.

ARCHITECTURE 111 ARCHIVED

Methods of Construction

2 UNITS - (CSU)

ARCHITECTURE 121 **Freehand Drawing** **2 UNITS - (RPT1) (UC:CSU)**

Lecture 1 hour; Laboratory 3 hours.

Students will learn fundamental architectural drafting and drawing techniques including perspective, coloring and rendering conventions and freehand drawing.

ARCHITECTURE 130 **History of Architecture I** **2 UNITS - (UC:CSU)**

Lecture 2 hours.

Students study architecture from prehistoric times to the beginning of the Renaissance and the geological, climatic, religious, social, and historical forces that help shape each period.

ARCHITECTURE 131 **History of Architecture II** **2 UNITS - (UC:CSU)**

Lecture 2 hours.

Students study architecture from the Renaissance to the present and the geographical, geological, climatic, religious, social, and historical forces that helped shape each period.

ARCHITECTURE 151 **Materials of Construction** **3 UNITS - (CSU)**

Lecture 3 hours.

Students examine the characteristics of building materials and its application in building construction within the overall context of architectural design. The fundamental building materials of wood, concrete, and steel shall be explored in depth. Their physical properties, historical context, and application within an architectural design shall be studied.

ARCHITECTURE 161 ARCHIVED

Introduction to Computer-Aided Architectural Design and Drafting

2 UNITS - (CSU)

ARCHITECTURE 162 **Computer Aided Design and Drafting** **3 UNITS - (CSU)**

Lecture 2 hour; Laboratory 4 hours.

Students learn and apply beginning AutoCAD 2-D drawing techniques to advance 2-D commands and 3-D modeling methods by completing a series of exercises. The latest version of the popular program is utilized. Important for students interested in the fields of architecture, interior design, and construction.

ARCHITECTURE 172 **Architectural Drawing I** **3 UNITS - (CSU)**

Lecture 1 hour; laboratory 5 hours.

First level architectural design and technical drawing methodology. Students design a simple one-story residence and prepare a complete set of design and technical drawings of the residence. Creative, conceptual and analytical skills are developed. Fundamental architectural drawing techniques as well as 3-D computer modeling methods are introduced. Some basic architectural principles, theories, order and methodologies are explored and incorporated into student projects. The profession of architecture and the practice of architects are clarified. Critical for students applying for work in the architectural or interior design fields as well as students interested in pursuing a higher degree in architecture school or related design field. Great also as a general education course to develop the creative mind and learn to draw architectural plans. Students will also create a portfolio of their work.

ARCHITECTURE 173 **Architectural Drawing II** **3 UNITS - (CSU)**

Lecture 1 hour; laboratory 5 hours.

Prerequisite: Architecture 172 with a satisfactory grade.

Second level architectural design and technical drawing methodology. Students design a two-story residence addressing a range of complex contextual and environmental issues, including passive energy design principles. A complete set of design and technical drawings of the residence will be produced. Creative, conceptual and analytical skills are developed. Fundamental architectural drawing techniques as well as 3-D computer modeling methods are refined. Critical for students applying for work in the architectural or interior design fields as well as students interested in pursuing a higher degree in architecture school or related design field. Students will also create a portfolio of their work.

ARCHITECTURE 201 **Architectural Design I** **3 UNITS - (UC:CSU)**

Lecture 1 hour; laboratory 5 hours

Prerequisite: Environmental Design 102 with a satisfactory grade.

Third level architectural design studio. Students design large and complex projects addressing significantly broader issues both architecturally and contextually. Complex project programmatic requirements are studied and organized in architecturally coherent fashion. Drawing, rendering, computer and model making skills are further refined. Students will examine and analyze the architectural formal and spatial design principles, theories, order and methodologies of significant architects and incorporate them into student projects. Students will also create a portfolio of their work.

ARCHITECTURE 202**Architectural Design II**
3 UNITS - (UC:CSU)*Lecture 1 hour; laboratory 5 hours.**Prerequisite: Architecture 201 with a satisfactory grade.*

Fourth level architectural design studio. Student imagination, vision and foresight are nurtured through the conception and development of a high density housing community of the near future. Issues of urban fabric, quality of neighborhood, support infrastructure, and transportation will be examined and addressed in the proposed community.

ARCHITECTURE 221 **ARCHIVED**

Architectural Rendering

2 UNITS - (CSU)**ARCHITECTURE 222****Architectural Graphics**
3 UNITS - (UC:CSU)*Lecture 1.5 hour; laboratory 4.5 hours.*

Students learn architectural drafting and drawing conventions. Students practice standard techniques to draw plans, elevations, sections, axonometrics, and perspectives as well as non-traditional methods. A variety of media are explored and utilized to create a range of graphic outcome. The course also covers some basic conceptual training and development of creative skills. Students will create a portfolio of their work from this and other design courses.

ARCHITECTURE 223**Portfolio Development**
1 UNIT - (CSU)*Laboratory 2 hours.*

Students study and examine the principles of portfolio design. Students will conduct research and analyze professionally designed brochures and portfolios to determine their characteristics and critique their effectiveness and to assist students in planning out and assembling their work into a quality portfolio.

ARCHITECTURE 271**Architectural Drawing III**
3 UNITS - (CSU)*Prerequisite: Architecture 173 a satisfactory grade.**Lecture 1 hour; Laboratory 5 hours.*

Third level architectural design and technical drawing methodology. Students design a multiple story residence on a down slope site addressing a range of complex contextual and environmental issues, including passive energy design principles. Different building materials such as concrete and metal will be studied and incorporated into the building. A complete set of design and technical drawings of the residence will be produced. Creative, conceptual and analytical skills are further developed. Fundamental architectural drawing techniques as well as 3-D computer modeling methods are refined. Students will create a portfolio of their work.

ARCHITECTURE 272**Architectural Drawing IV**
3 UNITS - (CSU)*Prerequisite: Architecture 271 with a satisfactory grade.**Lecture 1 hour; Laboratory 5 hours.*

Fourth level architectural design and technical drawing methodology. Students design a multi-story mid density residence which will address a range of complex contextual and environmental issues, passive energy design principles and code compliance design. Different building materials such as concrete and metal will be studied and incorporated into the building. A complete set of design and technical drawings of the residence will be produced. Creative, conceptual and analytical skills are further developed. Fundamental architectural drawing techniques as well as 3-D computer modeling methods are refined. Students will create a portfolio of their work.

ARMENIAN**ARMENIAN 1****Elementary Armenian I**
5 UNITS - (UC:CSU)*Lecture 5 hours. Laboratory 1 hour.**Advisory: English 28 and 67.*

The student completes the fundamentals of pronunciation and elementary grammar, practical vocabulary and useful phrases to understand, read and write simple Armenian.

ARMENIAN 2**Elementary Armenian II**
5 UNITS - (UC:CSU)*Lecture 5 hours. Laboratory 1 hour.**Prerequisite: Armenian 1 with a satisfactory grade or equivalent.*

The students learn the elementary grammar, reading and comprehension of simple text, with emphasis on oral expression. It also includes an introductory study of Armenian culture to complement comprehension of language.

ARMENIAN 3**Elementary Armenian II**
0 UNIT (RPT 2)*Laboratory 3 hours.**Prerequisite: Armenian 2.*

Heritage and non-heritage speakers of Armenian who possess limited skills would develop the opportunity to use the laboratory materials and programs to acquire/improve their Armenian.

ART**ART 101****Survey of Art History I**
3 UNITS - (UC:CSU)*Lecture 3 hours**Advisory: English 73 or equivalent.*

Students study the development of art from the pre-historic period to the time of the Renaissance emphasizing the cultural context of the West, and its major points of contact with the non-European world.

ART 102**Survey of Art History II
3 UNITS - (UC:CSU)**

Lecture 3 hours; laboratory 6 hours.

Advisory: English 28 and 67 or equivalent.

Students learn about the development of Art from the time of the Renaissance to the Early 20th Century. Emphasis is placed on the cultural context of the West while major points of artistic contact with the Non-European world is considered.

ART 103**Art Appreciation
3 UNITS - (UC:CSU)**

Lecture 3 hours.

Advisory: English 28 and 67 or equivalent.

The student learns about art forms and media in traditional and contemporary styles including terminology and problems of definition, meaning, and evaluation in the visual arts.

ART 105**History of Asian Art
3 UNITS - (UC:CSU)**

Lecture 3 hours.

Advisory: English 28 and 67 or equivalent.

The student learns about the development of Asian art from prehistoric times through the 20th Century including the artistic traditions and histories of China, India, Japan, Korea, and Southeast Asia. The student will consider how cultural, political, and religious forces influenced the arts and explore how the various regions of Asia formed and influenced one another.

ART 107**Mexican Art - Modern
3 UNITS - (UC:CSU)**

Lecture 3 hours.

Advisory: English 28 and 67 or equivalent.

The student learns about the pictorial arts of Mexico prior to and during the 20th Century including the periods from the pre-Historic through the Mexican influence on the arts of the United States.

ART 109**The Arts of Africa, Oceania and Ancient America
3 UNITS - (UC:CSU)**

Lecture 3 hours.

Advisory: English 73 or equivalent.

Students study the Arts of Africa, Oceania and Ancient America in the context of history, religion and general culture.

ART 111**History of Contemporary Art
3 UNITS - (UC:CSU)**

Lecture 3 hours.

Advisory: English 73 or equivalent.

Students study major trends in Art from 1900 to the present day including the artists, critics, and historical contexts leading to the development of Modern-ism and Post Modernism.

ART 185**Directed Study - Art Honors
1 UNITS**

Lecture 1 hour.

Students pursue on their own an in-depth study of a subject of special interest to them in studio art. Students work independently but consult with the instructor on a weekly basis to critique their work.

ART 201**Drawing I
3 UNITS - (UC:CSU)**

Lecture 2 hours; Laboratory 2 hours.

Students learn various drawing and techniques in several black and white media with emphasis on the development of observation and skill in graphic representation.

ART 202**Drawing II
3 UNITS - (UC:CSU)**

Lecture 2 hours; Laboratory 2 hours.

Prerequisite: Art 201 and 501 with satisfactory grades.

A continuation of Drawing I with continued emphasis on technical, observational and analytical aspects of drawing with the addition of color media as well as mixed drawing media. Projects are designed to test conceptual skills.

ART 204**Life Drawing I
3 UNITS - (UC:CSU)**

Lecture 2 hours; Laboratory 2 hours; Discussion 1 hour.

Prerequisite: Art 201 with a satisfactory grade.

Co-requisite: Art 501.

Drawing from the live model in various mediums, solving problems related to structure, anatomy, composition and expressive design.

ART 205**Life Drawing II
3 UNITS - (UC:CSU)**

Lecture 2 hours; Laboratory 2 hours.

Prerequisite: Art 204 with a satisfactory grade.

Students continue drawing and painting from the live model in various media, solving more complex problems related to structure, anatomy, composition and design.

ART 206**Life Drawing III
3 UNITS - (UC:CSU)**

Lecture 2 hours; Laboratory 2 hours.

Prerequisite: Art 205 with a satisfactory grade.

Students continue drawing and painting from the live model in various media, solving complex problems related to structure, anatomy, composition, expressive design.

ART 207**Life Drawing IV
3 UNITS - (UC:CSU)**

Lecture 2 hours; Laboratory 2 hours.

Prerequisite: Art 206 with a satisfactory grade.

Students continue drawing and painting from the live model while developing a more personal drawing style. Emphasis is on deepening and broadening the student's mastery of drawing and creating the human form.

ART 209**Perspective Drawing I
3 UNITS - (UC:CSU)**

Lecture 2 hour; Laboratory 2 hours.

Students learn to draw three-dimensional objects in space using measured vanishing point systems along with direct observation and freehand drawing. Students explore methods of drawing cast shadows and mirror reflections in perspective.

ART 285
Directed Study - Art Honors
2 UNITS

Lecture 2 hours.

Students pursue on their own an in-depth study of a subject of special interest to them in studio art. Students will create art works of special interest to them under guidance of the instructor.

ART 300
Introduction to Painting
3 UNITS - (UC:CSU)

Lecture 2 hour; Laboratory 2 hours.

Prerequisite: Art 201 with a satisfactory grade.

Co-requisite: Art 501.

Students learn the technique of watercolor painting applied to still life, landscape and the human figure using transparent watercolors as the medium.

ART 301
Watercolor Painting I
3 UNITS - (UC:CSU)

Lecture 2 hours; Laboratory 2 hours.

Prerequisite: Art 300 with a satisfactory grade.

Students expand their knowledge of watercolor painting, composition and color while continuing to explore art concepts, content and imagery.

ART 302
Watercolor Painting II
3 UNITS - (UC:CSU)

Lecture 2 hours; Laboratory 2 hours.

Prerequisite: Art 301 with a satisfactory grade.

Students expand their knowledge of watercolor painting, composition and color while continuing to explore art concepts, content, and imagery as applied to personal expression.

ART 303
Watercolor Painting III
3 UNITS - (UC:CSU)

Lecture 2 hours; Laboratory 2 hours.

Prerequisite: Art 302 with a satisfactory grade.

Students expand their knowledge of watercolor painting, composition and color while continuing to explore art concepts, content, and imagery with special emphasis on personal style.

ART 304
Acrylic Painting I
3 UNITS - (UC:CSU)

Lecture 2 hours; Laboratory 2 hours.

Prerequisite: Art 201 and 501 with a satisfactory grade.

Students learn a variety of techniques employing acrylic paints and related grounds and tools. Students explore a variety of subject matter and stylistic approaches.

ART 305
Acrylic Painting II
3 UNITS - (UC:CSU)

Lecture 2 hours; Laboratory 2 hours.

Prerequisite: Art 304 with a satisfactory grade.

Students continue technical and media explorations and develop creative uses of the aesthetic concepts of painting and drawing..

ART 306
Acrylic Painting III
3 UNITS - (UC:CSU)

Lecture 2 hours; Laboratory 2 hours.

Prerequisite: Art 305 with a satisfactory grade.

Students expand their exploration of aesthetic concepts and subject matter with emphasis on personal interpretation. See UC credit limits at the beginning of this section.

ART 307
Oil Painting I
3 UNITS - (UC:CSU)

Lecture 1 hour; Laboratory 5 hours.

Prerequisite: Art 201 and Art 501 with satisfactory grades or better.

Students develop skills in handling the oil painting medium. Students work from still life and landscape, the live model.

ART 308
Oil Painting II
3 UNITS - (UC:CSU)

Lecture 1 hour; Laboratory 5 hours.

Prerequisite: Art 307 with a satisfactory grade.

Students explore the oil painting medium in a variety of perceptual problems. Students work from the study of still life, landscape, and the live model.

ART 309
Oil Painting III
3 UNITS - (UC:CSU)

Lecture 1 hour; Laboratory 5 hours.

Prerequisite: Art 308 with a satisfactory grade.

Students explore the oil painting medium in a variety of perceptual problems. Students work toward individual growth and development of personal concepts.

ART 385
Directed Study - Art Honors
3 UNITS

Lecture 2 hours.

Students pursue on their own an in-depth study of a subject of special interest to them in studio art. Students will create art works of special interest to them under guidance of the instructor.

ART 400
Introduction to Print Making
3 UNITS - (UC:CSU)

Lecture 1 hour; Laboratory 6 hours

Prerequisite: Art 201 and 501 with satisfactory grades or better.

Students learn various forms of plate-making and printing. With a focus on visual ideas.

ART 401
Etching I
3 UNITS - (UC:CSU)

Lecture 1 hour; Laboratory 5 hours.

Prerequisite: Art 400 with a satisfactory grade.

Students learn etching and photo etching as forms of intaglio printing.

ART 402
Etching II
3 UNITS - (UC:CSU)

Lecture 1 hour; Laboratory 5 hours

Prerequisite: Art 401 with a satisfactory grade.

Students develop skills and proficiency in applying print making techniques.

ART 407
Relief Printmaking I
3 UNITS - (UC:CSU)

Lecture 1 hour; Laboratory 5 hours

Prerequisite: Art 402 with a satisfactory grade.

Students learn relief and planographic processes. Students work in relief etching, multiple plates, and monotypes with emphasis on color.

ART 408
RELIEF PRINTMAKING II
3 UNITS - (UC:CSU)

Lecture 1 hour; *Laboratory 5 hours*

Prerequisite: Art 407 with a satisfactory grade.

Students explore contemporary print making techniques and the application of these techniques as creative expression in today's art fields.

ART 501
Beginning Two-Dimensional Design
3 UNITS - (UC:CSU)

Lecture 2 hours; *Laboratory 2 hours.*

Students learn visual thinking and expression by working with the basic methods and concepts of composition and the basic elements of line, shape, value and color. Students study the role of graphic communication in society.

ART 502
Beginning Three-Dimensional Design
3 UNITS - (UC:CSU)

Lecture 2 hours; *Laboratory 2 hours.*

Prerequisite: Art 501 with a satisfactory grade. Co-requisite: Art 201.

Students study concepts of three dimensional form with experimental problems in a variety of materials using various spatial constructions.

ART 503
Intermediate Design
3 UNITS - (UC:CSU)

Lecture 2 hours; *Laboratory 2 hours.*

Prerequisite: Art 201 and Art 501.

Students apply principles of design to intermediate-level projects that develop creative and conceptual skills for graphic communication. Students learn concepts that also apply to contemporary art media and technologies.

ART 604
Graphic Design I
3 UNITS - (CSU)

Lecture 2 hours; *Laboratory 2 hours.*

Prerequisite: Art 501 and Art 633 with satisfactory grades

Introductory graphic design—the field: its terminology, tools, and working methods. Emphasis is placed on basic hands-on and computer layout skills and their application to creative visual communication, with strong emphasis on typographical technical and historical elements.

ART 605
Graphic Design II
3 UNITS - (CSU)

Lecture 2 hours; *Laboratory 2 hours.*

Prerequisite: Art 604 and Art 633 with satisfactory grades. Co-requisite: Art 639.

Students will use computer graphics and traditional rendering skills to develop graphic design promotional advertising comprehensives and final layouts.

ART 606
Graphic Design III
3 UNITS - (CSU)

Lecture 2 hours; *Laboratory 2 hours.*

Prerequisite: Art 605, Art 633 and Art 639 with satisfactory grades.

Students will create illustrations and digital images for integration into page layout software to produce press-ready graphics.

ART 620
Illustration 1
3 UNITS - (CSU)

Lecture 2 hours; *Laboratory 2 hours.*

Prerequisite: Art 201 with a satisfactory grade.

Co-requisite: Art 501.

Students learn to use drawing and design techniques and media in solving problems in commercial illustration including editorial, illustration, book illustration and comics.

ART 633
Introduction to Computer Graphics
3 UNITS - (CSU)

Lecture 2 hours; *Laboratory 2 hours.*

Prerequisite: Art 501 with a satisfactory grade.

Introductory computer graphics course using Adobe Illustrator. The Macintosh operating system, color modes, file formats, basic scanning and printing techniques as well as web research will also be surveyed.

ART 634
Computer Graphics I: 3D Computer Graphics
3 UNITS - (CSU)

Lecture 2 hours; *Laboratory 2 hours.*

Prerequisite: Art 633 with a satisfactory grade.

Introductory still-image manipulation course using Adobe Photoshop.

ART 638
Computer Aided Art Laboratory
1 UNIT - (RPT 3) (CSU)

Laboratory 2 hours.

Co-requisite: Art 634.

This course provides essential computer time for students in Art 634 - Computer Graphics I:3D Computer Graphics.

ART 639
Digital Imaging
3 UNITS - (CSU)

Lecture 2 hours; *Laboratory 2 hours.*

Prerequisite: Art 633 with a satisfactory grade

Students will learn techniques in computer still image manipulation using Adobe Photoshop.

ART 700
Introduction to Sculpture
3 UNITS - (UC:CSU)

Lecture 1 hour; *Laboratory 5 hours.*

Prerequisite: Art 501 with a satisfactory grade.

Advisory: Art 201.

Students learn to use clay, plaster, and wood in creating sculpture. Students learn to apply the techniques of fabrication, carving, and molding to figure studies and abstract construction.

ART 701
Sculpture I
3 UNITS - (UC:CSU)

Lecture 1 hour; *Laboratory 5 hours.*

Prerequisite: Art 700 with a satisfactory grade.

Students increase their technical skills with special emphasis on additive and subtractive processes. Various materials will be considered and traditional techniques re-examined. Students will learn contemporary processes such as assemblage and fabrication.

**ART 702
Sculpture II****3 UNITS - (UC:CSU)***Lecture 1 hour; Laboratory 5 hours.**Prerequisite: Art 701 with a satisfactory grade.*

Students solve advanced problems in the various sculptural media with emphasis upon individual growth and direction. Students create sculpture using contemporary processes such as mixed media, installation or environmental concepts..

**ART 703
Sculpture III****3 UNITS - (UC:CSU)***Lecture 1 hour; Laboratory 5 hours.**Prerequisite: Art 702 with a satisfactory grade.*

Students solve advanced problems in an area of specialization: additive, subtractive, or mold making/casting processes. Students will focus on individual growth and the development of concepts through the medium of sculpture.

ART 708**Introduction to Ceramics****3 UNITS - (UC:CSU)***Lecture 1 hour; Laboratory 5 hours.**Prerequisite: Art 501 with a satisfactory grade.*

Students learn the basic methods of making pottery.

ART 709**Ceramics I****3 UNITS - (UC:CSU)***Lecture 1 hour; Laboratory 6 hours**Prerequisite: Art 708 with a satisfactory grade.*

Students learn technical and design skills on the potter's wheel and in making ceramic molds.

ART 710**Ceramics II****3 UNITS - (UC:CSU)***Lecture 1 hour; Laboratory 5 hours.**Prerequisite: Art 709 with a satisfactory grade.*

Students master technical and design skills on the potter's wheel, making ceramic molds, and slip casting.

ART 711**Ceramics III****3 UNITS - (UC:CSU)***Lecture 1 hour; Laboratory 5 hours.**Prerequisite: Art 710 with a satisfactory grade.*

Students master technical and design skills on the potter's wheel, making ceramic molds, slip casting, and glaze mixing as well as developing style.

ASTRONOMY**ASTRONOMY 1****Elementary Astronomy****3 UNITS - (UC:CSU)***Lecture 3 hours.**Advisory: English 28 and 67.*

A fascinating look into the general principles and the fundamental facts of astronomy. This introductory course is designed for the non-technical student. Topics covered include the history and science of astronomy, the solar system, our sun, stars, galaxies and cosmology. No college math preparation is needed. If a student wishes to transfer this as a lab science course, the student must also complete Astronomy 5.

ASTRONOMY 5**Fundamentals of Astronomy Laboratory****1 UNIT - (UC:CSU)***Laboratory 3 hours.**Co-requisite: Astronomy 10 or 11**Advisory: Astronomy 1*

Astronomy 5 laboratory course offers a presentation of the methods and techniques used by astronomers to determine the nature of the universe. This course uses some very basic mathematics, and can be taken by non-science and/or science majors. When taken together with Astronomy 1 or Astronomy 10 or Astronomy 11, a student's 'science with a lab' transfer and graduation requirement is met. Topics covered in Astronomy 5 include star names, asterisms and constellations, sky motion, planet motion, orbital motion, stellar brightness, stellar spectrum, crater formation, star clusters, galaxies and deep sky objects. An important part of the course involves working with and learning the operation of astronomical instruments and equipment including celestial globes, astrolabes, azimuth sundials, astronomical binoculars and computer controlled telescopes.

ASTRONOMY 10 ARCHIVED**The Solar System****3 UNITS - (UC:CSU)****ASTRONOMY 11****Stars, Galaxies, and the Universe****3 UNITS - (UC:CSU)***Lecture 3 hours.*

This conceptual course surveys the universe beyond the solar system. Students learn about stars, stellar evolution, black holes, galaxies, the big bang, cosmology and the possibility to extraterrestrial life.

ASIAN-AMERICAN STUDIES**ASIAN AMERICAN STUDIES 1****The Asian in America****3 UNITS - (UC:CSU)***Lecture 3 hours.*

Survey of the Asian American in American society, including the Asian cultural heritage and the social, political, economic, and cultural development of the Asian American communities in the American setting from an Asian American perspective.

ASIAN AMERICAN STUDIES 6 ARCHIVED

Introduction to Asian Music

3 UNITS - (UC:CSU)

(Same as Music 133)

BIOLOGY

BIOLOGY 1 ARCHIVED
Fundamentals of the Life Sciences I
3 UNITS - (UC:CSU)

BIOLOGY 3
Introduction to Biology
4 UNITS - (UC:CSU)

Lecture 3 hours; Laboratory 4 hours.
Advisory: English 21.

Credit not allowed for Biology 3, 3H to students who have previous credit for Biology 1, 6, 23, 25.

Presents a survey of biological principles, of activities, and of relationships of living organisms to each other and the world they live in, with emphasis on their correlations to the human organism. Includes a study of nutritional, medical, genetic and eugenic aspects in a modern world.

BIOLOGY 3H ARCHIVED
Introduction to Biology
4 UNITS - (UC:CSU)

BIOLOGY 6
General Biology I
5 UNITS - (UC:CSU)

Lecture 3 hours; Laboratory 6 hours.
Prerequisite: Mathematics 125 and Chemistry 60 or Chemistry 68 with a satisfactory grade or equivalent.
Advisory: English 21 or equivalent.

Presents the principles of molecular biology, cell structure and function, genetics, evolution and organization at the tissue level in plants and animals.

UC limit: No credit allowed for Biology 1, 3, 23 or 25 if taken after Biology 6.

BIOLOGY 7
General Biology II
5 UNITS - (UC:CSU)

Lecture 3 hours; Laboratory 6 hours.
Prerequisite: Chemistry 60 or Chemistry 68, and Biology 6 with a satisfactory grade or equivalent. Advisory: Eligibility for English 28 and 67 or equivalent.

Presents the principles of organization at the organ and organ system levels, embryology, ecology, and behavior.

BIOLOGY 23 ARCHIVED
Biological Principles I
3 UNITS - (UC:CSU)

BIOLOGY 25
Human Biology
3 UNITS - (UC:CSU)

Lecture 3 hours.
Advisory: Eligibility for English 28 and 67 or equivalent.

Credit not allowed for Biology 25 to students who have previous credit for Biology 1, 3, 6, 23.

This is a survey course for the non-science major. The principle human organ systems are studied according to structure and function. Problems of pollution, population control, and preservation of the natural environment will be discussed.

BIOLOGY 185 ARCHIVED
Directed Study - Biology
1 UNIT - (CSU)

BIOLOGY 285 ARCHIVED
Directed Study - Biology
2 UNITS - (CSU)

BIOLOGY 385 ARCHIVED
Directed Study - Biology
3 UNITS - (CSU)

BUSINESS

BUSINESS 1
Introduction to Business
3 UNITS - (UC:CSU)

Lecture 3 hours.
Advisory: English 28 and 67 or equivalent.

A survey of business including forms of business organization, finance, personnel problems, marketing, managerial aids, business-government relations; and business terms and concepts.

BUSINESS 15
Business Statistics
3 UNITS - (UC:CSU)

Lecture 3 hours.
Prerequisite: Mathematics 125 with a satisfactory grade or equivalent.

This course teaches Measures of Central Tendency, Measures of Dispersion, Normal Distribution, Hypothesis Testing, Correlation and Analysis of Variance.

UC limit: Maximum one course from Mathematics 225 and Business 15.

BUSINESS 17
Computer Graphics for Business
3 UNITS

Lecture 1.5 hours; Laboratory 2.5 hours.
Pre-requisite: Business 1.

A comprehensive course in business graphics covering types of business graphics, their uses and techniques for generating graphics emphasizing computer usage, computer techniques and current computer graphics software.

BUSINESS 38
Business Computations
3 UNITS - (CSU)

Lecture 3 hours.
Advisory: English 28 and 67 or equivalent.

Note: Credit allowed for only one of Business 38 or Accounting 31.

Problems in ordinary business situations and on civil service examinations. Arithmetic fundamentals, including addition, subtraction, multiplication and division of whole numbers and fractions are reviewed. Practical problems include interest, cash and trade discount, mark-up and mark—down, payrolls, and percentage.

CAOT (COMPUTER APPLICATIONS & OFFICE TECHNOLOGIES)

CAOT 1 Computer Keyboarding I 3 UNITS - (A)

Lecture 2 hours; Laboratory 3 hours.
Advisories: Eligibility for ESL Level 6B and 6C.

Students develop a salable skill—computer keyboarding by touch; minimum speed at end of course, 30wpm accurately; formatting of letters, memos, tables, and simple reports using word processing software.

CAOT 2 Computer Keyboarding II 3 UNITS - (CSU)

Lecture 2 hours; laboratory 3 hours.
Prerequisite: Computer Keyboarding I or equivalent.

Mastery of the keyboard (letters, numbers, and symbols) by touch. Minimum speed at end of course of 40 wpm accurately; formatting of mailable advanced letters, tables, reports, memos, and desktop published documents using Microsoft Word.

CAOT 3 Computer Keyboarding III 3 UNITS - (CSU)

Lecture 2 hours; laboratory 3 hours.
Prerequisites: Completion of CAOT 2 or CAOT 84 or a training course in Microsoft Word.

(Students who do not meet these prerequisites should enroll in either CAOT 2 or CAOT 9 and CAOT 84, Microsoft Word.) Develops production skills in using advanced features of Microsoft Word to create properly formatted business documents. Includes composition at keyboard, decision making, and timed production of letters, tables, and reports. Develops minimum speed at end of course of 50 wpm.

CAOT 6 ARCHIVED Adding and Calculating Machines 1 UNIT

CAOT 7 Machine Transcription 3 UNITS - (A)

Lecture 3 hours; laboratory 1 hour.
Prerequisite: CAOT 31 with a satisfactory grade or equivalent.
Advisory: CAOT 1 or ability to key 30wpm.

Students develop proficiency in operating transcribing software on the computer to accurately transcribe a variety of business documents from taped dictation using word processing software. Students thoroughly review English fundamentals and strengthen keyboarding and proofreading skills.

CAOT 9 Keyboarding Improvement 1 UNIT - (RPT 3) (A)

Laboratory 3 hours.
Prerequisite: CAOT 1

The student improves keyboarding procedures through continued emphasis on correct keyboarding techniques and develops speed and accuracy through timed writings and corrective drills.

CAOT 14 Microcomputer Office Applications: PowerPoint 2 UNITS - (A)

Lecture 1 hour; laboratory 3 hours.
Prerequisite: CAOT 82.

This course uses application software to develop proficiency in the operation of Microsoft PowerPoint. It develops the skill to create, modify, and retrieve various presentations, the skill to integrate PowerPoint with other programs, and the skill to use visuals in the presentation.

CAOT 20 Medical Office Procedures 5 UNITS - (A)

Lecture 5 hours.
Prerequisites: CAOT 2 or 31 with a satisfactory grade or equivalent. Advisory: CAOT 44.

This course develops proficiency in typing medical documents, case histories, medical reports, history and physicals. Additionally, students learn about medical ethics and sensitivity training for the medical office, privacy laws, telephone etiquette, medical filing and handling of confidential documents, scheduling appointments in a variety of medical facilities and medical insurance.

CAOT 23 Legal Procedures I 5 UNITS - (A)

Lecture 5 hours.
Advisories: CAOT 1 with satisfactory grades or equivalent.

Preparation of court pleadings and legal documents; knowledge of general law office procedures and specific procedures involved in litigation, family law, corporate law, and other specialties; development of attitudes and behaviors appropriate for the legal field.

CAOT 31 Business English 3 UNITS - (A)

Lecture 3 hours.
Prerequisite: English 28 and 67 with a satisfactory grade or equivalent. Required of all CAOT majors.

Students learn English grammar and punctuation rules; practice in writing sentences and paragraphs.

CAOT 32 Business Communications 3 UNITS - (CSU)

Lecture 3 hours.
Prerequisites: CAOT 1 and 31 with a satisfactory grade or equivalent.

Credit is allowed for only one of the following courses: CAOT 32 or Supervision 12.

Applications of business communications, principles in writing a variety of business letters, interoffice memorandums, and a business report; improvement of general and business vocabularies.

CAOT 33 Records Management And Filing 3 UNITS - (A)

Lecture 1 hour; Laboratory 2 hour.

Students learn creation, storage, disposition and preservation of all types of documents using alphabetic, geographic, numeric, and subject methods. Includes database management on a microcomputer.

CAOT 34
Business Terminology
2 UNITS - (A)

Lecture 2 hours.

Correct definition, spelling, pronunciation, and effective usage of the general and specialized vocabulary used in modern business communications.

CAOT 43
Office Procedures
3 UNITS - (A)

Lecture 3 hours.

Prerequisites: CAOT 2 and CAOT 31 with satisfactory grades or better.

Comprehensive knowledge and application of office skills and procedures for the automated office; development of attitudes for success on the job.

CAOT 44
Medical Terminology
3 UNITS - (A)

Lecture 3 hours.

Students develop an understanding of medical terminology through a study of word roots, prefixes, and suffixes and body systems. Students' emphasis is also given to spelling, pronunciation, and definitions.

CAOT 46
Machine Transcription for Medical Secretaries
3 UNITS - (A)

Lecture 2 hours; Laboratory 2 hours.

Prerequisites: CAOT 2 and CAOT 31 with satisfactory grades or equivalent.

Advisory: CAOT 44 or equivalent.

Proficiency in applying basic filing principles to a variety of records using alphabetic, geographic, numeric and subject methods. Creation, storage, disposition, and preservation of all types of documents. An understanding of concepts of automated storage and retrieval. Includes database.

CAOT 47
Applied Office Practice
2 UNITS - (RPT 3) (A)

Lecture 1 hour; Laboratory 4 hours.

Advisory: CAOT 1 with a satisfactory grade or equivalent and second semester standing.

Practical experience in working in an office on campus and lectures relating to office behavior, productivity, motivation, and interpersonal skills.

CAOT 49
Machine Transcription for Legal Office Assistants
3 UNITS - (A)

Lecture 2 hours; laboratory 2 hours.

Prerequisites: CAOT 2 and 31 with satisfactory grades or equivalent.

This course develops proficiency in operating transcribing machines to transcribe legal correspondence and documents, including court documents, from cassette tape. Emphasis is placed on spelling, proofreading, formatting, and the meaning of legal terms.

CAOT 64
Computer Applications and Office Technologies Lab
1 UNIT - (RPT 3)(A)

Laboratory 32 hours.

Co-requisite: Enrollment in another CAOT discipline course.

Laboratory class which provides opportunity for students

enrolled in CAOT classes to have additional time on the computers to work with all of the software that is offered in the Department. Students must attend a minimum of 32 class hours per semester. In addition to lab hours that are required for any other classes student is enrolled in. Credit/No Credit.

CAOT 79
Word Processing Applications
3 UNITS - (A)

Lecture 1 hour; laboratory 4 hours.

Prerequisites: CAOT 84 and CAOT 31 with satisfactory grades or equivalent.

Further develops skill in preparing a variety of business documents on a personal computer. This course covers the different formats used for letters, memos, reports, tables, outlines, form documents, graphics, desk-top publishing, and merged documents.

CAOT 82
Microcomputer Software Survey in the Office
3 UNITS - (CSU)

Lecture 2 hours; laboratory 3 hours.

Prerequisites: CAOT 1 and CAOT 98 with satisfactory grades or equivalent.

Introduces students to the use of the microcomputer and commercially available software used in business office. Course provides hands-on introduction to word processing, database, spreadsheet, graphics, desktop publishing and presentation design software.

CAOT 84
Microcomputer Office Applications: Word Processing
3 UNITS - (RPT 2) (CSU)

Lecture 2 hours; Laboratory 3 hours.

Advisories: ESL Level 5B and completion of CAOT 1 with a satisfactory grade or equivalent.

Use basic and advanced commands in Microsoft Word or other word processing software, to create, format, edit, save, and print documents including letters, tables, reports, and merge documents. Use desktop publishing features to create newsletters, brochures, fliers, and resumes.

CAOT 85
Microcomputer Office Applications: Spreadsheet
3 UNITS - (CSU)

Lecture 1 hour; laboratory 4 hours.

Students learn office spreadsheet applications using a PC and spreadsheet application software, such as Excel. Students are taught to create, edit, format, and print worksheets; construct graphs and build databases that utilize the data table function.

CAOT 86
Microcomputer Office Applications: Database
3 UNITS - (CSU) (RPT 2)

Lecture 2 hours; laboratory 3 hours.

Advisory: CAOT 1.

This course is designed to teach office database applications using a relational database program, such as MS Access. Records design, file creation and maintenance, data manipulation, report formats, and printing are covered. Office applications, such as records for personnel, inventory, and sales, are emphasized. Graphing and integration with a word processing program to produce automated mailings are included.

CAOT 88
Microcomputer Office Applications:
Desktop Publishing
3 UNITS - (RPT 2) (A)

Lecture 2 hours; laboratory 3 hours.

Provides information and hands on training using a personal computer, laser printers and various desktop publishing software including Microsoft Publisher. Includes producing camera ready, near typeset quality reports, newsletters, business forms, and presentations.

CAOT 93
Legal Document Preparation
2 UNITS - (A)

Lecture 2 hours.

Prerequisites: CAOT 1 and CAOT 84 with satisfactory grades or equivalent.

This course is designed to link the academic knowledge of law and skills of word processing to result in the production of legal documents.

CAOT 95
Microsoft Excel Review for MOS Certification
1 UNIT- (UC:CSU)

Lecture .5 hour; laboratory 1.5 hours.

Advisory: CAOT 85 or equivalent.

This course provides a review of Microsoft Excel concepts needed to pass the Microsoft Office Specialist (MOUS) examination for the Core Level. Emphasizes the objectives specified by Microsoft to attain certification. This course offers a comprehensive up to date review for Excel users who wish to refresh their skills and knowledge in using Excel.

CAOT 97
Introduction to the Internet
3 UNITS - (A) (RPT 2)

Lecture 2 hours; laboratory 3 hours.

This course is designed to prepare students to use the Worldwide Computer Network, Internet. The course emphasizes the features of the Internet, including Electronic Mail, File Transfer Protocol, Internet Explorer, and other services and utilities

CAOT 98
Microcomputer Office Applications:
Introduction to Windows for CAOT
3 UNITS - (A)

Lecture 1 hour; laboratory 4 hours.

Students prepare to work in the Windows environment. Emphasizes the feature of Windows, including changing and creating icons, opening and closing windows and other applications, responding to dialog boxes, and working with directories.

CAOT 102 ARCHIVED
Success Skills for the Workplace
3 UNITS

CAOT 104 ARCHIVED
Professional Image
3 UNITS

CAOT 105
School-to-Work-Portfolio
2 UNITS - (A)

Lecture 2 hours.

Prerequisite: CAOT 31 with a satisfactory grade or equivalent.

Advisory: Eligibility for ESL 6B and 6C or completion of CAOT 1.

Course includes preparation of a comprehensive professional portfolio that contains a résumé, cover letter,

application for employment, reference letters, and personal achievement. The course will also include career planning, networking with business and industry, and job search using the Internet and other resources.

CAOT 106 ARCHIVED
Computer Calculations for the Ten-Key Pad
3 UNITS - (A)

CAOT 112
Microcomputer Office Applications:
Web Page Design
3 UNITS - (RPT 2) (CSU)

Lecture 2 hours; laboratory 3 hours.

Advisory: CAOT 98 or equivalent.

This course is designed to help students learn the most important topics of Web Page Design. The course emphasizes creating a new website, integrating a database using Microsoft Office components, styles, and working with HTML codes.

CAOT 126
Introduction to Medical Coding/Billing
3 UNITS - (A)

Lecture 3 hours.

Prerequisite: CAOT 44.

Introduction to the medical codes used for diagnostic and procedural data in medical billing. Students will learn to use the CPT-4 and ICD-9 reference books. Medicare, MediCal, and private insurance forms will be used for real world applications. Introduction to medical billing forms and procedures required by Medicare and private medical insurance companies will also be covered.

CAOT 911
Cooperative Education 911 – CAOT
3 UNITS

Lecture 1 hour.

Prerequisite: CAOT 79

Students receive credit for approved internships with an employer in the field of Computer Applications Office under the direction of the Cooperative Education director. The worksite must be approved by the CAOT Department Chair.

CAOT 921
Cooperative Education 921 – CAOT
3 UNITS

Lecture 2 hours.

Prerequisite: CAOT 79

Students receive credit for approved internships with an employer in the field of Computer Applications Office under the direction of the Cooperative Education director. The worksite must be approved by the Department Chair.

CAOT 931
Cooperative Education 931 – CAOT
3 UNITS

Lecture 3 hours.

Prerequisite: CAOT 79

Students receive credit for approved internships with an employer in the field of Computer Applications Office under the direction of the Cooperative Education director. The worksite must be approved by the Department Chair.

CAOT 941
Cooperative Education 941 – CAOT
3 UNITS

Lecture 4 hours.

Prerequisite: CAOT 79

Students receive credit for approved internships with an employer in the field of Computer Applications Office under the direction of the Cooperative Education director. The worksite must be approved by the Department Chair.

CHEMISTRY

TRANSFER LIMITS: UC gives no credit for Chemistry 51, 60, 68 if taken after Chemistry 101.

CHEMISTRY ENROLLMENT INFORMATION

Enrollment in all chemistry classes is based on completion of the required prerequisites with satisfactory grades or better.

Students enrolling in Chemistry 101 who have not completed the Chemistry 60/Chemistry 68 prerequisite or the equivalent must pass the Chemistry Readiness Exam in order to be eligible to take this course. Please contact the Assessment Office at 323.953.4000 ext. 2264 for more information.

Students enrolling in Chemistry 60 or 68 who have not completed Math 115 or the equivalent must take the mathematics placement assessment prior to enrolling in either of these courses.

All Chemistry classes recommend completion of English 28 and 67 or its equivalent or concurrent enrollment in Learning Skills 1, Reading, and Learning Skills 7, Basic Composition, and Speech Communication 113. To confirm enrollment in Chemistry Department classes, bring your College assessment score card, and proof of the prerequisites completed to the first class meeting.

INFORMATION FOR PRE-NURSING STUDENTS:

All LACC pre-nursing students must complete Chemistry 60 or Chemistry 68 with a satisfactory grade to satisfy the chemistry requirement for the LACC Nursing Program. Chemistry 51 does not satisfy the LACC Nursing chemistry requirement.

CHEMISTRY 51
Fundamentals of Chemistry I
5 UNITS - (UC:CSU)

Lecture 3 hours. Laboratory 4 hours.

Advisory: Mathematics 115 or Placement exam.

Students learn the scientific, social, political, and economic aspects associated with their chemical environment. Fundamental chemical principles are developed and then applied to various topics of interest involving the student's life or environment. Topics covered include but are not limited to energy and fuels, nuclear chemistry, environmental chemistry, forensic chemistry, nutrition and health, household products, drugs, and poisons. In the laboratory students will learn general procedures used by chemists and be introduced to the uncertainty involved in such operations.

CHEMISTRY 60
Introduction to General Chemistry
5 UNITS - (UC:CSU)

Lecture 3 hours. Laboratory 4 hours.

Prerequisite: Mathematics 115 or appropriate score on the placement assessment.

Advisory: English 28 and 67 or 31. See "Chemistry Enrollment Information."

A general basic chemistry course with laboratory, emphasizing fundamental principles of inorganic and physical chemistry, nomenclature of inorganic compounds, ionic and covalent bonding, problem solving, gas laws and solutions. This course serves as preparation for Chemistry 101, and meets the IGETC and CSU general education requirements for physical science with laboratory.

CHEMISTRY 68
Preparation for General Chemistry
5 UNITS - (UC:CSU)

Lecture 3 hours. Conference 2 hours. Laboratory 4 hours.

Prerequisite: Math 115 or appropriate score on the placement assessment

Advisory: English 28 and 67. See "Chemistry Enrollment Information."

A general basic chemistry course with laboratory and conference sections, emphasizing fundamental principles of inorganic and physical chemistry, nomenclature of inorganic compounds, ionic and covalent bonding, problem solving, gas laws and solutions. This course serves as preparation for Chemistry 101, and satisfies the IGETC and CSU general education requirements for physical science with laboratory.



CHEMISTRY 101
General Chemistry I
5 UNITS - (UC:CSU)

Lecture 3 hours. Conference 2 hours. Laboratory 4 hours.
 Prerequisite: Chemistry 60 or 68 and Mathematics 125
 Advisory: English 28 and 67.

Note: Students who have not completed Chemistry 60 or 68 or the equivalent are required to pass the chemistry readiness examination prior to enrolling in Chemistry 101. See "Chemistry Enrollment Information."

Lecture topics include nomenclature, atomic structure, quantum theory, bonding theories and molecular geometry, chemical equations, stoichiometry, thermochemistry, solid, liquid and gaseous states and related forces, gas laws, solutions and colligative properties, periodic relationships, and acid base theories. Laboratory exercises are quantitative in nature and are related to the lecture topics

CHEMISTRY 102
General Chemistry II
5 UNITS - (UC:CSU)

Lecture 3 hours. Conference 2 hours. Laboratory 4 hours.
 Prerequisite: Chemistry 101 and Mathematics 125
 Advisory: English 28 and 67.

Lecture topics include chemical kinetics, general and ionic equilibria, thermodynamics, electrochemistry and redox reactions, structure and bonding in transition metal complexes and carbon compounds. Laboratory topics include reaction kinetics, equilibrium constant determination, chemical and spectroscopic methods of qualitative and quantitative analysis, potentiometric titration techniques, and electrochemistry for both organic and inorganic systems.

CHEMISTRY 211
Organic Chemistry for Science Majors I
5 UNITS - (UC:CSU)

Lecture 3 hours. Conference 2 hours. Laboratory 4 hours.
 Prerequisites: Chemistry 102. Advisory: English 28 and 67.

Introduces the structure, nomenclature and reactions and properties of organic compounds. Introduces spectroscopy as applied to organic compounds. Preparation and isolation of organic compounds and determination of physical properties are studied in the laboratory.

CHEMISTRY 212
Organic Chemistry for Science Majors II
5 UNITS - (UC:CSU)

Lecture 3 hours. Conference 2 hours. Laboratory 4 hours.
 Prerequisite: Chemistry 211. Advisory: English 28 and 67.

Introduces the structure, reactions, nomenclature and properties of organic compounds, and spectroscopic techniques. Laboratory work includes the synthesis of compounds, the use of spectroscopy and the determination of compound identity based on properties and reactions.

CHEMISTRY 221
Biochemistry for Science Majors
5 UNITS - (UC:CSU)

Lecture 3 hours. Conference 2 hours. Laboratory 4 hours.
 Prerequisite: Chemistry 211.

This course is intended as a preparation for careers in the physical and biological sciences, medical and dental professions, veterinary and agricultural science, nutrition and food chemistry, and related fields. Topics relate to the chemistry and metabolism of biological compounds and include discussion of proteins, lipids, carbohydrates and nucleic acids. Laboratory work includes electrophoresis, chromatography, spectroscopy, and enzyme purification and kinetics.

CHEMISTRY 185 DIRECTED STUDY -
1 UNIT (CSU) (RPT2)

Lecture 1 hour.
 Prerequisite: Chemistry 102.
 Advisory: English 28 and 67.

CHEMISTRY 285 DIRECTED STUDY -
2 UNIT (CSU)

Lecture 2 hours.
 Prerequisites: Chemistry 102
 Advisory: English 28 and 67.

CHEMISTRY 385 DIRECTED STUDY -
3 UNIT (CSU)

Lecture 3 hours.
 Prerequisite: Chemistry 102
 Advisory: English 28 and 67.

Students pursue Directed Study in Chemistry on a contract basis under the direction of a supervising instructor. Laboratory and literature research is performed.

CHICANO STUDIES

CHICANO STUDIES 7
The Mexican American in the History of the
United States I
3 UNITS - (UC:CSU)

Lecture 3 hours.

Note: Meets the Associate in Arts degree requirements in U.S. History, U.S. Constitution, and California State and Local Government.

Credit allowed for only one of Mexican American Studies 7 or African-American Studies 4 or History 11. UC limit: One course from Chicano Studies 7, African-American Studies 4, History 11.

This course traces the historical evolution of persons of Mexican descent and their institutions to 1850. It surveys the contributions of Mexican-descended persons to the development of the United States with particular emphasis on the present-day U.S. Southwest.

CHICANO STUDIES 8
THE MEXICAN AMERICAN IN THE
HISTORY OF THE UNITED STATES II
3 UNITS - (UC:CSU)

Lecture 3 hours.

Note: Meets the Associate in Arts degree requirements in U.S. History, U.S. Constitution, and California State and Local Government.

Credit allowed for only one of Mexican American Studies 8 or African-American Studies 5 or History 12 or 13. UC limit: One course from Chicano Studies 8, African-American Studies 5, History 12, 13.

The course examines Chicano historical experiences from the nineteenth century to the present. The course focuses on the social, historical, and political tensions between American dominant society and Chicano communities. It also examines the U.S. constitution and U.S. political systems.

CHICANO STUDIES 44
Mexican Civilization
3 UNITS (UC:CSU)

Lecture 3 hours.

This course is a board survey of Mexican civilization and culture. The course covers the periods of prehistoric expansion of Mesoamerica, Pre-Columbian Mexican civilization, the Spanish conquest, the colonial period, and Mexico in the 19th and 20th century.

CHICANO STUDIES 52**Mexican Art - Modern
3 UNITS - (UC:CSU)***Lecture 3 hours.**Advisory: English 73 or equivalent.*

A survey of the pictorial arts of Mexico prior to and during the 20th Century. Studies the broad range of the arts including the evolution of a Mexican- American art and iconography.

CHILD DEVELOPMENT**CHILD DEVELOPMENT 1****Child Growth and Development
3 UNITS - (UC:CSU)***Lecture 3 hours.**Co-requisite: English 21 and 67 or equivalent.*

An introductory Child Development course that examines the major physical, psychosocial, and cognitive/language developmental milestones for children, both typical and atypical, from conception through adolescence. There is an emphasis on interactions between maturational processes and environmental factors. While studying developmental theory and investigative research methodologies, students will observe children, evaluate individual differences and analyze characteristics of development at various stages.

CHILD DEVELOPMENT 2**Early Childhood Principles and Practices
3 UNITS - (CSU)***Lecture 3 hours.**Co-requisite: English 28 and 67 or 31 or equivalent, and Child Development 1.*

Note: Verification of annual Mantoux test (or chest x-ray) is required.

A survey course which compares and analyzes historical as well as current models of early childhood programs. Students examine the underlying theoretical principles of developmentally appropriate practices applied to programs and environments. Emphasis is placed on the key role of relationships, constructive adult-child interactions and teaching strategies that support physical, social, creative and intellectual development of children and lead to desired learning outcomes. Professional development and career paths based upon CA Child Developmental Permit Matrix will be discussed.

CHILD DEVELOPMENT 3**Creative Experiences for Children I
3 UNITS - (CSU)***Lecture 3 hours.**Prerequisite: Child Development 2 or equivalent.*

Students develop and implement creative curriculum for young children. Activities include: sensory, motor, manipulative, art, music, movement, and dramatic play experiences. Emphasis is on environments that promote creativity and the role of the teacher. Enrollment recommended in CD 84 OR 85: Child Development Labs one hour TBA a week to develop activities and lessons.

CHILD DEVELOPMENT 4**Creative Experiences for Children II
3 UNITS - (CSU)***Lecture 3 hours.**Prerequisite: Child Development 2 or equivalent.*

Implementation and evaluation of curriculum in the areas of language arts, natural and physical sciences, mathematics, and the social sciences. Emphasis of discussion is on creating an environment to support a balance of child initiated and teacher initiated experiences.

CHILD DEVELOPMENT 7**Introduction to Curriculum in Early Childhood
Education I****3 UNITS- (CSU)***Lecture 3 hours.**Prerequisite: CH DEV 2*

Students learn and develop the knowledge and skills to provide appropriate curriculum and environments for young children from birth to age 6. Students examine a teacher's role in supporting development and fostering the joy of learning for all young children using observation and assessment strategies emphasizing the essential role of play. Planning, implementation and evaluation of curriculum, includes but not limited to: language and literacy, social and emotional learning, sensory learning, art and creativity, math, natural and physical sciences.

CHILD DEVELOPMENT 10**Health, Safety and Nutrition
3 UNITS - (CSU)***Lecture 3 hours.**Co-requisite: English 21 and 67 or equivalent.*

Students study the interrelationship of health, safety and nutrition and the impact on children's growth and development. The key components that ensure physical health, mental health and safety for both children and staff are identified along with the importance of collaboration with families and health professionals. Students learn how to implement a comprehensive nutritional program, use universal health precautions and implement emergency procedures.

CHILD DEVELOPMENT 11**Home, School and Community Relations
3 UNITS - (CSU)***Lecture 3 hours.**Co-requisite: English 21 and 67 or equivalent.*

Students examine the developing child in a societal context focusing on the interrelationship of the family, school and community and emphasizes historical and sociocultural factors. The processes of socialization and identity development will be highlighted, showing the importance of respectful, reciprocal relationships that support and empower families. Some topics covered are: social influences on parenting styles, communication, child-rearing and the relationships between the child, family and the school is studied.

CHILD DEVELOPMENT 22
Practicum in Child Development I
4 UNITS - (CSU)

Lecture 2 hours. Laboratory 2 hours.

Prerequisite: Child Development 3 and 4.

Note: Verification of annual Mantoux test (or chest x-ray) is required.

Students are assigned to an approved Child Development program to demonstrate developmentally appropriate early childhood teaching competencies under guided supervision. Students utilize practical classroom experiences to make connections between theory and practice, develop professional behaviors, and build a comprehensive understanding of children and families. Child centered, play-oriented approaches to teaching, learning, assessment and knowledge of curriculum content areas is emphasized as student teachers design, implement and evaluate experiences that promote positive development and learning.

CHILD DEVELOPMENT 23
Practicum in Child Development II
4 UNITS - (CSU)

Prerequisite: Child Development 22 or equivalent.

Lecture 2 hours. Laboratory 6 hours per week.

Note: Verification of current Mantoux test (or chest x-ray) is required.

This course provides an advanced practicum experience. Students apply assessment strategies to plan, implement, and evaluate developmentally appropriate activities. Techniques that promote partnerships between teachers and families are developed. An educational philosophy statement, a resume and a professional portfolio are created. Students assigned to directed practicum teaching in a child development center demonstrate professional and ethical behaviors.

CHILD DEVELOPMENT 30
Infant and Toddler Studies I
3 UNITS - (CSU)

Lecture 3 hours.

Co-requisite: English 21 or equivalent.

Note: Verification of current Mantoux test (or chest x-ray) is required.

The study of the physical, cognitive, social/emotional development of infants from birth to toddlerhood. Respectful care giving practices, developmentally appropriate environments, responsive curriculum, and health and safety issues will be covered. Students learn strategies for observing infants and care giving settings.

CHILD DEVELOPMENT 31
Infant and Toddler Studies II
3 UNITS - (CSU)

Lecture 3 hours.

Advisory: English 21 or equivalent.

Note: Verification of current Mantoux test (or chest x-ray) is required.

The study of the principles of inclusive, respectful, care giving for infants and toddlers. Topics include: typical and atypical development, appropriate environments, curriculum, infant care licensing; observation, assessment and intervention plans; and tools for family communications and home visits.

CHILD DEVELOPMENT 34
Observing and Recording Children's Behavior
3 UNITS - (CSU)

Lecture 3 hours.

Prerequisite: Child Development 1 and English 28 and English 67 or equivalent.

Note: Verification of current Mantoux test (or chest x-ray) is required.

Students learn the appropriate use of assessment and observation strategies to document development, growth, play and learning to join with families and professionals in promoting children's success. Recording strategies, rating systems, portfolios, and multiple assessment tools are explored.

CHILD DEVELOPMENT 35
Fostering Literacy Development in Young Children
3 UNITS - (CSU)

Lecture 3 hours.

Advisory: English 21/73 or equivalent.

Students interested or currently working in the field of early childhood education will build skills in promoting literacy in children birth through age five. Students will develop a strong foundation in early reading and writing within a developmentally appropriate approach.

CHILD DEVELOPMENT 38
Administration and Supervision of Early Childhood Programs I
3 UNITS - (CSU)

Lecture 3 hours.

Prerequisite: Child Development 3, 4 and 11 or equivalent.

Students are prepared to establish and administer an early childhood program. Financial aspects of administration and legal rules and regulations pertaining to establishing a center are emphasized. Students apply licensing information and knowledge of regulations to design an appropriate environment, create a fiscal plan, marketing strategy and develop an enrollment and hiring process. This course partially fulfills the licensing requirements for the director.

CHILD DEVELOPMENT 39
Administration and Supervision of Early Childhood Programs II
3 UNITS - (CSU)

Lecture 3 hours.

Prerequisite: Child Development 3, 4 and 11 or equivalent.

This course provides training for administrators of Early Childhood Programs on a variety of topics pertaining to supervision of early childhood programs. Topics discussed include: state and federal regulations, computer applications for administration, grant and proposal development, advocacy, leadership skills and team management techniques, developing a comprehensive parent partnership working with Desired Results, and legal issues. This course partially fulfills the licensing requirement for the director.

CHILD DEVELOPMENT 42
The Child in a Diverse Society
3 UNITS - (CSU)

Lecture 3 hours.

Advisory: English 21 and 67 or equivalent.

Students examine the development of social identities in diverse societies including theoretical and practical implications of oppression and privilege as they apply to young children, families, programs, classrooms and teaching. Various classroom strategies are explored emphasizing culturally and linguistically appropriate anti-bias approaches supporting all children in becoming competent members of a diverse society. Student utilize self-examination to reflect on issues related to social identity, stereotypes and bias, social and educational access, media and schooling.

CHILD DEVELOPMENT 44
Programs for Children with Special Needs I
3 UNITS - (CSU)

Advisory: English 21 or equivalent.

May be offered in alternate semesters. This course is designed for students interested in specializing in or working with children with special needs. Students examine components of a comprehensive service delivery system that is based on legal mandates and an understanding of typical and atypical development across all domains. Also discussed is the role of observation and documentation in adapting the environment, creating instructional strategies and in developing Individual Education Plans.

CHILD DEVELOPMENT 45
Programs for Children with Special Needs II
3 UNITS - (CSU)

Lecture 3 hours.

Advisory: English 21 and 67 or equivalent.

Note: Verification of Mantoux test (or chest x-ray) is required. Students learn about programs for exceptional children and best practices for inclusion of children with special needs into educational settings as close to their typically developing peers as possible. Students explore a variety of disabilities from a child development perspective includes definition, and educational implications.

CHILD DEVELOPMENT 46
School Age Programs I
3 UNITS - (CSU)

Lecture 3 hours.

Co-requisite: English 21 or equivalent.

Students are introduced to before/after school age program philosophies. Students examine children's growth and development in various developmental domains, evaluate community programs and their philosophies, create activities exploring the use of standards and critique before/after school-age program environments.

CHILD DEVELOPMENT 47
School Age Programs II
3 UNITS - (CSU)

Lecture 3 hours.

Co-requisite: English 21 or equivalent.

This course is designed for students interested in working in before/after school age program. Students apply guidance techniques to create positive relationships, analyze cultural diversity issues and work to promote effective home, school and community relations. Direction in areas of leadership, advocacy, and professional growth in school age programs are presented. Administrative requirements for school age programs, guidelines and organizational skills needed to provide adult supervision of school age programs and create a safe and healthy environment are discussed.

CHILD DEVELOPMENT 48
Positive Guidance in Early Childhood Settings
3 UNITS - (CSU)

Lecture 3 hours.

Prerequisite: Child Development 2 or equivalent.

Exploration of developmentally appropriate management techniques for children in early childhood settings. Emphasis is on developing culturally sensitive individualized plans for behavior management of traditional and special needs children.

CHILD DEVELOPMENT 53
Parenting
3 UNITS - (CSU)

Lecture 3 hours. Advisory: Child Development 1, Child Development 11, and English 21.

Designed to assist parents and others interested in parent training, in developing a philosophy & guidelines for effective parenting. Parent-child relationships, alternatives in parenting style, and the impact of family dynamics is explored.

CHILD DEVELOPMENT 65
Adult Supervision and Early Childhood Mentoring
2 UNITS - (A)

Lecture 2 hours.

Prerequisite: Child Development 23 or 38 and 39 or equivalent.

This course satisfies the Child Development Permit Master Teacher adult supervision requirement and is designed for students who currently, or will supervise adults in an early childhood program. Students compare methods and principles of supervision and mentoring as well as how to develop positive team relationships and utilize conflict resolution techniques.

CHILD DEVELOPMENT 84
Child Development Lab
0.5 UNITS - (A) (RPT 3)

Laboratory 1 hour.

Co-requisite: One of the following Child Development 2, 3/4, 10, 22/23, 30/31, 35, 42, 4/45, and 46/47.

Students interested, or currently working in the field of Child Development, or taking Child Development classes, may use lab materials, curriculum resource books, technology and equipment to design lesson plans, games, and other curricular activities. A \$20 lab fee is required.

CHILD DEVELOPMENT 85
Child Development Lab II
0.5 UNITS - (A) (RPT 3)

Laboratory 1 hour.

Prerequisite: Child Development 84 or equivalent.

Students interested in continuing The Child Development Lab experience will focus on quality literary experiences such as exposure to age-appropriate literacy materials, and (modeling or practicing) library habits under the supervision of a literacy expert. Students will evaluate and analyze literacy materials, be able to write activity plans, and create instructional materials that support emerging literacy. A \$25.00 lab fee is required.

CHILD DEV 185 DIRECTED STUDY —
1 UNIT (CSU) (RPT 3)

Lecture 1 hour.

CHILD DEV 285 DIRECTED STUDY —
2 UNITS (CSU)

Lecture 2 hours.

CHILD DEV 385 DIRECTED STUDY —
3 UNITS (CSU)

Lecture 3 hours.

Note: A maximum of 3 units in Directed Study may be taken for credit.

This class enables child development students to pursue on their own an in- depth study of a subject of special interest in the field of Child Development. Consultation with the instructor on a weekly basis, plus independent work is required.

CHINESE

CHINESE 1 Elementary Chinese I 5 UNITS - (UC:CSU)

Lecture 5 hours. Laboratory 1 hour.
Advisory: English 28 and 67.

Mandarin Chinese corresponds to the first year of high school Chinese. Pronunciation, grammar, practical vocabulary, and basic facts on the geography, customs and culture of China.

CHINESE 2 Elementary Chinese II 5 UNITS - (UC:CSU)

Lecture 5 hours. Laboratory 1 hour.
Prerequisite: Chinese 1 with a satisfactory grade or equivalent.
Completes the elementary Mandarin Chinese grammar; introduces reading and writing of elementary texts.

CHINESE 3 Intermediate Chinese I 5 UNITS - (UC:CSU)

Lecture 5 hours. Laboratory 1 hour.
Prerequisite: Chinese 2 with a satisfactory grade.
A review of grammar with vocabulary building for conversational fluency, written composition and advanced reading.

CHINESE 4 Intermediate Chinese II 5 UNITS - (UC:CSU)

Lecture 5 hours. Laboratory 1 hour.
Prerequisite: Chinese 3 with a satisfactory grade.
Continues a review of grammar, advanced composition and reading of everyday and literary subjects to study idiomatic expressions.

CHINESE 10 Chinese Civilization 3 UNITS - (UC:CSU)

Lecture 3 hours.
Advisory: English 28.
This course offers the students lectures and discussions in English on history, culture, geography, government and institutions of China; the life style and customs of the people; the language. Literature, arts, and sciences; the contributions to civilization.

CHINESE 21 Fundamentals of Chinese I 3 UNITS - (UC:CSU)

Lecture 3 hours. Laboratory .5 hour.
Advisory: English 28 and 67.
This course is designed to introduce the fundamentals of Mandarin Chinese pronunciation, grammar structure, practical vocabulary, and basic Chinese character writing system. Chinese 21 and Chinese 22 are equivalent to Chinese 1. UC limit: 5 Units from Chinese 21, 22.

CHINESE 22 Fundamentals of Chinese II 3 UNITS - (UC:CSU)

Lecture 3 hours. Laboratory .5 hour.
Prerequisite: Chinese 21 with a satisfactory grade or equivalent.
The fundamentals of Chinese grammar and daily conversation at the second level of the Chinese language are continued. The second level of writing 100 Chinese characters is introduced. Chinese 21 and Chinese 22 are equivalent to Chinese 1. UC limit: 5 units from Chinese 21, 22.

CINEMA

Transfer Limit: UC maximum limit: refer to www.assist.org.

CINEMA 1 Introduction to Motion Picture Production 3 UNITS - (UC:CSU)

Lecture 2 hours. Laboratory 2 hours.
Required of all Cinema majors; open to all students.
A comprehensive introduction to film video production techniques and equipment. Proper procedures are explained for the use of digital and film cameras, lenses, filters, film stocks, lights, microphones, audio recorders, and other motion editing picture equipment. Attention is also given to production planning and post-production as well. Cinema 2 should be taken concurrently.

CINEMA 2 Beginning Motion Picture Workshop 3 UNITS - (UC:CSU)

Lecture 1 hour. Laboratory 4 hours.
Required of all Cinema majors. Open to all students.
Introductory workshop in practical filmmaking. Each student is responsible for the making of short films in digital video. Cinema 1 may be taken concurrently.

CINEMA 3 History of Motion Pictures 3 UNITS - (UC:CSU)

Lecture 2 hours. Laboratory 2 hours.
Required of all first semester Cinema majors; open to all others.
History of the development of motion pictures, with examples, from their beginnings to the present day. Emphasis is placed on the American feature film.

CINEMA 4 History of the Documentary Film 3 UNITS - (UC:CSU)

Lecture 2 hours. Laboratory 2 hours.
Required of all first semester Cinema majors; enrollment open to all others.
The development of films dealing with the truth. Films types seen and discussed include: historical, animated, propaganda, educational, commercial, cinema verite and direct cinema. Students will develop critical standards for judging documentary films.

CINEMA 5 Introduction to Screenwriting 3 UNITS - (RPT 1) (CSU)

Lecture 2 hours. Laboratory 2 hours.
Prerequisite: Cinema 1, 2, 3, and 4 with satisfactory grades or better. Required of all Cinema majors.
Students develop and write screenplays. Cinema majors write the scripts for films they will make in Cinema 15 or 33.

CINEMA 6 Motion Picture Photography 3 UNITS - (CSU)

Lecture 2 hours. Laboratory 2 hours.
Prerequisite: Cinema 1, 2, 3, 4, with satisfactory grades or better. Required of all Cinema majors.
This course is an introduction to cinematography, including optics, photo emulsion, camera operation, laboratory procedures, terminology and aesthetics. Students will do individual and group projects using 16 mm or digital video camera equipment.

CINEMA 7
Advanced Cinematography and Creative Techniques

3 UNITS - (CSU)

Lecture 2 hours. Laboratory 2 hours.

Prerequisite: Cinema 6 with a satisfactory grade or better.

An advanced course in creative cinematography covering sophisticated professional equipment and techniques used in the motion picture industry. Emphasis is placed on lighting and current industry standards.

CINEMA 9
Motion Picture Sound

3 UNITS - CSU

Lecture 1 hour, Laboratory 4 hours.

Prerequisite: Cinema 1, 2, 3, 4 with satisfactory grades or better.

Students learn the basics of motion picture production and post-production sound. Students use digital audio recorders, microphones and booms and learn how to properly record sound. Students learn to loop and mix sound using a digital audio program.

CINEMA 10
INTRODUCTION TO FILM DIRECTING

3 UNITS - (RPT 1) CSU

Lecture 2 hours, Laboratory 2 hours

Prerequisite: Cinema 1,2,3, 4 with satisfactory grades or better.

The student is introduced to the crafts of acting and directing for the film medium.

CINEMA 15
Advanced Motion Picture Workshop

3 UNITS - (RPT 1) (CSU)

Lecture 1 hour. Laboratory 4 hours.

Prerequisite: Cinema 5, 6, 9, 10, 20 and 32 with satisfactory grades or better.

Advanced Students perform practical work in film or digital video production. This lecture and laboratory workshop emphasizes the creative use of the camera, editing, sound, and production activities in relation to the fiction or documentary film format. Each student will be responsible for making a short film.

CINEMA 16 ARCHIVED
 Motion Picture Workshop II
 3 UNITS - (A)

CINEMA 17 ARCHIVED
 Advanced Motion Picture Post-Production
 3 UNITS - (A)

CINEMA 20
Business Aspects of Motion Picture Production

3 UNITS - (A)

Lecture 3 hours

Prerequisite: Cinema 1, 2, 3, 4, with satisfactory grades or better.

The student surveys cinema business practices including financing, production and distribution.

CINEMA 22
Digital Audio Post Production with Pro Tools

3 UNITS - (RPT 1) (A)

Lecture 2 hours. Laboratory 2 hours.

Prerequisite: Cinema 9 or 32 or 33 or TV 55 with a satisfactory grade or better.

Advanced television and cinema students are introduced to digital audio editing, multi-track mixing and other digital audio post-production with ProTools.

CINEMA 25
Producing Digital Video Features

3 UNITS - (A)

Lecture 3 hours

Digital video (DV and HD) is transforming traditional feature film production and broadening distribution possibilities for independent productions. Students explore this new frontier and its requirements for intellectual property, financing, contracts, production, formats, marketing and alternative distribution outlets including internet web sites and downloads.

CINEMA 32
Editing Fundamentals

3 UNITS - (A)

Lecture 1 hours. Laboratory 4 hours.

Prerequisite: Cinema 1, 2, 3 and 4 with satisfactory grades or better.

Intermediate students learn the principles of editing using digital non-linear editing equipment.

CINEMA 33
Digital Video Production Workshop I

3 UNITS - (RPT 1) (A)

Lecture 1 hours. Laboratory 4 hours.

Prerequisite: Cinema 1, 2, 3, and 4 with satisfactory grades or better.

Intermediate film and television students will produce short video projects using digital video cameras and editing systems.

CINEMA 34
Motion Picture Soundstage Production Practicum

3 UNITS - (RPT 1) (A)

Lecture 1 hour. Laboratory 4 hours

Prerequisite: One of the following - Cinema 5 or 6 or 7 or 9 or 10 or 32 with satisfactory grades or better.

Designed for students to gain practical experience in a specific area of motion picture soundstage production in order to develop the necessary skills needed in that field of the industry. Included skills are screenwriting, directing, production management, lighting, cinematography, sound recording and editing.

CINEMA 35
Non-linear Editing with Final Cut Pro

3 UNITS - (RPT 1) (A)

Lecture 2 hours. Laboratory 2 hours.

Prerequisite: Cinema 32 with satisfactory grades or better.

Advanced film students are introduced to Final Cut Pro non-linear software and the skills and documentation required to work in an industry standard editing environment. The students, using the software, edit a number of exercises in news, documentary, and narrative formats using supplied footage.

CINEMA 38
Modern Picture Stage Grip

3 UNITS - (RPT 1) (A)

Lecture 2 hours. Laboratory 2 hours.

Open to all students.

In this hands-on course, students learn basic grip skills and operate grip equipment and tools used in motion picture stages, television studios, and on location during film and television production including, but not limited to, a Grip Cart, C-Stands, Apple Boxes, Scaffolding, Manlifts, Gels, Ropes, Plates, Clamps, Wedges, Cribbing, Cucolori, Flags and Scrims, Gaffer Tape, Griffon, Gaffer Grips, and Mole-a-gators. Topics covered include stage safety, operating procedures, set etiquette, basic tool usage, basic grip equipment usage, and

basic lighting safety and lighting fixture usage. Students have the option to learn the safety and basic use of power tools in the construction of an Apple Box as an individual project.

CINEMA 60
Entertainment Industry
Careers Below-the-line
Production Skills I
3 UNITS

Lecture 2 hours. Laboratory 2 hours
Open to all students.

Introductory course to the skills needed to obtain and keep a position in the motion picture or television industries. Skills taught include working with production managers, first assistant directors, production designers, and script supervisors, with a focus on basic safety issues in each department.

CINEMA 61 ARCHIVE
 Entertainment Industry Careers Below-the-line
 Production Skills II
 3 UNITS

CINEMA 62 ARCHIVE
 Entertainment Industry Careers Below-the-line
 Production Skills III
 3 UNITS

CINEMA 63 ARCHIVE
 Entertainment Industry Careers Corporate Skills I
 3 UNITS

CINEMA 64 ARCHIVE
 Entertainment Industry Careers Corporate Skills II
 3 UNITS

CINEMA 911 COOPERATIVE
EDUCATION— 1 UNIT - (RPT3)

CINEMA 921 COOPERATIVE
EDUCATION— 2 UNITS CINEMA 931
COOPERATIVE EDUCATION— 3 UNITS

Prerequisite: Cinema 2 with a satisfactory grade or better.

Students receive credit for approved internships with an employer in the field of Motion Picture Production, under the direction of the Cooperative Education director. The worksite must be approved by the Department Chair.

COMPUTER TECHNOLOGY

COMPUTER TECHNOLOGY 1
Introduction to Computer for Technicians
4 UNITS - (CSU)

Lecture 3 hours. Laboratory 3 hours.
Advisory: English 28 and 67. No UC credit if taken after Spring 1994.

In this first course in the computer technology major students learn the physical aspects of computer hardware and low-level programming.

COMPUTER TECHNOLOGY 4
Introduction to Computer Networks
4 UNITS - (A)

Lecture 3 hours. Laboratory 3 hours.
Advisory: Computer Technology 1 or equivalent.

Introduces the concepts of networking, the OSI Model; methods of signaling and encoding; interfaces, modems, and transmission media; and examines the most important protocols involved in moving data over a communication network.

COMPUTER TECHNOLOGY 12
Introduction to Computer Hardware
4 UNITS - (CSU)

This course is one of two courses, CT-12 and CT-14, that prepare students to take the CompTIA A+ certification exam. The theory of the technology of computer hardware components: microprocessors, RAM, BIOS/CMOS, expansion bus, motherboard, power supply, HDD, FDD, CD, DVD, video and sound, and how these form a working system, maintenance and simple troubleshooting.

COMPUTER TECHNOLOGY 14
A-Plus Certification Preparation
4 UNITS - (A)

Lecture 3 hours. Laboratory 3 hours.

Prerequisite: Computer Technology 12

One of two courses on the computer hardware and operation to prepare students for CompTIA A+ certification exam. Includes technology of portable computers, printers, understanding, installing and upgrading Microsoft Windows operating systems, working with the Windows Command Line Interface, troubleshooting and maintenance of Windows, essentials of computer security, networking, and internet.

COMPUTER TECHNOLOGY 15
CompTIA Network+ Certification Preparation
4 UNITS

Lecture 3 hours. Laboratory 3 hours.

Prerequisite: Computer Technology 4 with a satisfactory grade.
 Provides an in-depth examination of the technology and skills necessary to install, configure, and operate local and wide-area computer networks. Prepare the student for the CompTIA Network+ Certification examination.

COMPUTER TECHNOLOGY 20
Computer Logic and Arithmetic
4 UNITS - (CSU)

Lecture 3 hours.. Laboratory 3 hours

Prerequisites: Electronics 4 and Electronics 20.

The student learns the essential number and logic theory upon which digital computers today are based, including principles and applications of logic devices used in digital systems, number systems, boolean algebra, logic and truth tables, logic gates, and bistable devices.

COMPUTER TECHNOLOGY 30
Introduction to Microprocessors
4 UNITS - (A)

Lecture 3 hours.. Laboratory 9 hours

Prerequisite: Computer Technology 20 with a satisfactory grade.

Co-requisite: Computer Technology 36.

Advisory: Electronics 8.

A survey of various microprocessor units with in-depth analysis and operation of a selected microprocessor. Emphasis is placed on the architecture, instruction set, I/O interfacing, and typical applications of the selected devices.

COMPUTER TECHNOLOGY 36**Digital Devices and Circuits****4 UNITS - (A)***Lecture 3 hours.. Laboratory 9 hours**Prerequisite: Computer Technology 20 with a satisfactory grade.**Advisory: Electronics 8.*

Covers digital integrated circuit devices such as registers, counters, encoder/ decoder, multiplexer/demultiplexer. Memory devices, and programmable logic arrays. Laboratory emphasizes use of dual-trace oscilloscope.

COMPUTER TECHNOLOGY 46**Microprocessor Input/Output Devices****4 UNITS - (A)***Lecture 3 hours.. Laboratory 9 hours**Prerequisite: Computer Technology 30 with a satisfactory grade.**Co-requisite: Computer Technology 48.*

Presents the theory and operation of input/output devices commonly used with microprocessor based systems. Includes the technologies used in disk drives, video displays, analog digital conversions, printers, and similar devices. Procedures for interfacing I/O systems are included.

COMPUTER TECHNOLOGY 47**Data Communications and Networking I****4 UNITS - (A)***Lecture 2 hours. Laboratory 3 hours.*

An introductory course in data communications and networking for the technician. The student will install and test modems and networks on PC computer systems.

**COMPUTER TECHNOLOGY 48****Microprocessor Systems****4 UNITS - (A)***Lecture 3 hours. Laboratory 3 hours.**Prerequisite: Computer Technology 30 with a satisfactory grade.**Co-requisite: Computer Technology 48.*

Examines selected topics in advanced microprocessor based systems, including advanced architectures, industrial control and robotics, networks, and multi user and multi processor systems. Laboratory is design oriented, and includes a project or term paper, field trips, seminars, and guest speakers.

COMPUTER TECHNOLOGY 119**Digital Home Technology****Integrator Certification Preparation****6 UNITS***Lecture 6 hours.*

Prepares the student for the "CompTIA-DHTI+ Certification Exam". Reviews principles of home technology systems, structured wiring, home computer networks design and installation, distributed audio/video systems, home lighting management systems, home communication systems, HVAC and water management, security and surveillance systems, home access control systems

COMPUTER TECHNOLOGY 120 ARCHIVED**Printed Circuit Board Design and Layout****5 UNITS - (CSU)****COMPUTER TECHNOLOGY 121 ARCHIVED****Printed Circuit Board Design Analysis****5 UNITS - (CSU)****COMPUTER TECH 185 DIRECTED STUDY — 1 UNIT (CSU)****COMPUTER TECH 285 DIRECTED STUDY — 2 UNITS (CSU)****COMPUTER TECH 385 DIRECTED STUDY — 3 UNITS (CSU)***Lecture 1 hour per unit.*

These courses allow students in Computer Technology to pursue Directed Study on a contract basis under the direction of a supervising instructor. Credit Limit: A maximum of 3 units in Directed Study may be taken for credit. *Prerequisites: Computer Technology 1 or 12 and concurrent enrollment or completion of Computer Technology 20.

CO SCI**Computer Science/
Information technology**

The official abbreviation for Computer Science/Information Technology (CSIT) is "CO SCI".

CO SCI 100**Workshop Laboratory****1 UNIT - (RPT 3) (A)***Laboratory 3 hours.*

This course is designed to supplement and enhance learning experience in other computer-related courses by providing tutorial and self-help assistance with computers, programs, software, hardware and other learning aids.

CO SCI 101
Introduction to Computers and Their Uses
4 UNITS - (UC:CSU)

Lecture 3 hours; laboratory 2 hours.

Advisory: English 73.

Credit not allowed if student has credit for CO SCI 103.

A general computer literacy course open to all students. Presents computer hardware, software, terminology, ethics, and societal impact. Students will overview operating systems, word processing, spreadsheets, database management systems, telecommunications, and networks.

CO SCI 103
Introduction to Computer Systems for MIS
4 UNITS - (UC:CSU)

Lecture 3 hours; laboratory 2 hours.

Advisory: English 73.

An introduction to computers for a one-semester transfer course or for certificates or a degree in CSIT. Topics include computers, programming and systems design, programming languages and flowcharting. Laboratory includes word processing, spreadsheets, database concepts and extensive programming in BASIC.

CO SCI 104
Mathematics for Programmers
3 UNITS - (CSU)

Lecture 3 hours; laboratory 6 hours.

Advisory: CO SCI 103 or equivalent.

Development of the specialized mathematical concepts necessary for writing computer programs, including the internal representation of numeric data, logical operators, set theory, vector and matrix operations, and linear equations.

CO SCI 106
Beginning Pascal Programming
4 units

Lecture 3 hours; laboratory 7 hours.

Prerequisite: CO SCI 104

Introduces the PASCAL programming language instructions and structures. Increasingly complex programs are designed and written in PASCAL by the students.

CO SCI 107
Programming Logic
3 UNITS - (UC:CSU)

Lecture 3 hours; laboratory 6 hours.

Prerequisite: CO SCI 103 with a satisfactory grade or better or equivalent.

Advisory: Mathematics 125 or equivalent.

Introduces the discipline of computer science using a high level language; provides an overview of computer organization and an introduction to software engineering. Includes program design, development, style, testing, documentation, algorithms, control structures, sub-programs, and elementary data structures.

CO SCI 108
Beginning Visual Basic Programming
3 UNITS - (UC:CSU)

Lecture 3 hours.

Prerequisite: CO SCI 101 with a satisfactory grade or better or equivalent.

A beginning programming course in the Visual Basic Programming Language.

CO SCI 117
Beginning Microcomputer Assembly Language Programming
3 UNITS

Lecture 3 hours; laboratory 2 hours.

This course introduces the student to symbolic programming languages and their application as diagnostic tools. The skills of writing and using programs will be stressed. Emphasis is placed on the use of diagnostic programs which can be used to troubleshoot and isolate computer problems.

CO SCI 133
Microcomputer Data Base Programming ARCHIVED
3 UNITS - (CSU)

CO SCI 134
Operating Systems
3 UNITS - (CSU)

Lecture 2 hours; laboratory 6 hours.

Prerequisite: CO SCI 101 or 103 with a satisfactory grade or better or equivalent.

Fundamental principles functions, application and use of operating systems such as DOS, UNIX, Windows 98/NT/2000, and Netinase and related applications software. Analysis of capabilities and limitations of the different operating systems and environments. Applicable to A+ certification software preparation.

CO SCI 136
Introduction to Data Structures
3 UNITS - (UC:CSU)

Lecture 2 hours; laboratory 6 hours.

Prerequisite: CO SCI 140 with a satisfactory grade or better or equivalent.

Principles and applications of data structures. Design implementation, and analysis of algorithms to manipulate arrays, lists, stacks, queues, trees, graphs, and other objects. Examination of sorting and searching methods. Recursive and object-oriented programming techniques.

CO SCI 138
Advanced Visual Basic Programming
3 UNITS - (UC:CSU)

Lecture 2 hours; laboratory 2 hours.

Prerequisite: CO SCI 108 with a satisfactory grade or better or equivalent.

An advanced programming course in the Visual Basic .Net programming language with objects, classes, exception handling, GUI, DBMS, SQL, ASP.NET, Data Structures, and Recursion.

CO SCI 139
Programming in C
3 UNITS - (UC:CSU)

Lecture 2 hours; Laboratory 2 hours.

Prerequisite: CO SCI 103 with satisfactory grades or better.

The student learns all CS1 topics including Problem Analysis and Program Design, Simple Data Types, Streams and File I/O, Control Structures, Functions, Arrays, and Strings, emphasizing procedural programming with C++.

CO SCI 140**C++ Programming II
3 UNITS - (UC:CSU)**

Lecture 2 hours. Laboratory 2 hours.

Prerequisite: CO SCI 139 with a satisfactory grade or better or equivalent.

Student learns Object-Oriented and Advanced programming with C++ including Classes, Data Abstractions, Inheritance, Composition, Virtual Functions, Operators & Functions Overloading, Templates, Exception Handling, Recursion, Pointers, Dynamic Data Types, and Linked Lists.

CO SCI 141**Programming in JAVA
3 UNITS - (UC:CSU)**

Lecture 2 hours. Laboratory 2 hours.

Prerequisite: CO SCI 101 or CO SCI 103 with a satisfactory grade or better or equivalent.

Advisory: CO SCI 107 and CO SCI 104.

An introductory university-level course of a leading-edge programming paradigm object-oriented programming that is truly portable and therefore appropriate for implementing internet-based and World-Wide Web based applications.

CO SCI 142**Advanced JAVA
3 UNITS - (A)**

Lecture 2 hours. Laboratory 3 hours.

Prerequisite: CO SCI 103 and 141 with a satisfactory grade or better or equivalent.

This is a sequel to CO SCI 141. It covers numerous topics beyond the introductory Java course. Topics included are: (1) UML, (2) Multithreading, (3) Networking, (4) Exception handling, (5) Recursion, (6) Files & Streams, (7) JDBC, and (8) Generics. This course will prepare a student to tackle the Sun Certified Java Programmer industry certification Exam.

CO SCI 144**Practical Extraction and Report Language (PERL)
3 UNITS - (UC:CSU)**

Lecture 2 hours. Laboratory 2 hours.

Prerequisite: CO SCI 158 with a satisfactory grade or better or equivalent.

An introductory university-level course in Practical Extraction and Report Language (PERL), a standard tool for UNIX server administration and server side support of interactive World Wide Web pages.

CO SCI 148**Advanced Spreadsheet
Applications
3 UNITS - (CSU)**

Lecture 2 hours. Laboratory 2 hours.

Prerequisite: CO SCI 101 or 103 with a satisfactory grade or better or equivalent.

A course in advanced spreadsheet operations, including nested functions, data tables, exporting/importing data, what-if analysis, macro development, macrologic, printing enhancements and spreadsheet systems development.

CO SCI 151**Macromedia Dreamweaver
4 UNITS - (A)**

Lecture 2 hours. Laboratory 2 hours.

Advisory: CO SCI 108 with a satisfactory grade or better or equivalent.

Students receive an extensive practical and theoretical framework for using Macromedia's Dreamweaver to develop websites. It includes enhancements for web page layout, coding, and Webmaster-user interactivity, ASP language

fundamentals, server – and client-side scripting, ASP object model, cookies, error handling, scripting objects, record sets, transactions and COM+, XML introduction, ADO object model, and VBScript reference.

CO SCI 152**Macromedia Flash
3 UNITS - (A)**

Lecture 2 hours. Laboratory 2 hours.

Advisory: CO SCI 151 with a satisfactory grade or better or equivalent.

Students learn Macromedia's Flash; a state-of-the-art Web animation software for creating highly-compact, vector-based content for transmission over the Internet. Topics presented include introduction to ActionScript, Event Handlers, objects and Dynamic Data.

CO SCI 155**E-Commerce Programming
3 UNITS - (A)**

Lecture 2 hours. Laboratory 2 hours.

Prerequisite: CO SCI 158 with satisfactory grades or better or equivalent.

Presents the practical aspects of programming a functional e-commerce web site, including item selection, purchase recap, on-line payments, and follow-up data collection. Makes use of the PHP programming language and a live SQL database manager for implementation and record keeping. The student constructs a live e-commerce web site with all aspects of the technique implemented.

CO SCI 156**XML Programming
3 UNITS - (CSU)**

Lecture 2 hours. Laboratory 2 hours.

Prerequisite: CO SCI 158 with a satisfactory grade or better or equivalent.

This course offers hands-on experience in designing and programming XML documents that enable the structured delivery of data and information over a corporate intranet, the internet, or for simple XML messaging between HTTP servers. The course also provide skills to build business-to-business E-commerce applications.

CO SCI 158**Hyper-Text Markup Language (HTML)
3 UNITS - (CSU)**

Lecture 2 hours. Laboratory 2 hours.

Prerequisite: CO SCI 101 with a satisfactory grade or better or equivalent.

The student learns basic internet concepts and technologies. The student learns to develop web sites by applying concepts like tables, layers, cascading styles sheets, frame sets, image maps, lists, forms, and control dynamic content using basic JavaScript.

CO SCI 159**Web Projects
3 UNITS - (CSU) (RPT 2)**

Lecture 2 hours. Laboratory 2 hours.

Prerequisite: CO SCI 158 with a satisfactory grade or better or equivalent.

Covers more complex topics in rapidly changing technology of web pages construction including multimedia developments, plug-ins, helper applications, CSS, DHTML and new developments. Students will complete web projects with emphasis placed upon recent developments in students and software.

CO SCI 160 ARCHIVED
Business Systems Design
3 UNITS - (CSU)

CO SCI 167 ARCHIVED
Microcomputer Operating Environments - Windows
3 UNITS - (CSU)

CO SCI 168
The UNIX Operating System
3 UNITS - (CSU)

Lecture 2 hours. Laboratory 2 hours.
Prerequisite: CO SCI 101 with a satisfactory grade or better or equivalent.

Covers basic features of the UNIX operating system including commands and concepts for running, application handling files, directories, permissions, networking, and scripting.

CO SCI 169
Apache Web Server
3 UNITS - (CSU)

Lecture 2 hours. Laboratory 2 hours.
Prerequisite: CO SCI 168 with a satisfactory grade or better or equivalent.

A course covering the tasks involved in administering an Internet web server running Apache web server software under UNIX.

CO SCI 170
UNIX System Administration
3 UNITS- (CSU)

Lecture 2 hours. Laboratory 2 hours.
Prerequisite: CO SCI 168

Students master skill in UNIX system administration including user addition and management, system disk drive installation and preparation, application installation, network installation and configuration, printer attachment, boot procedures and scripting, and management of event logging. The students builds a UNIX server from scratch and configures it to required specifications.

CO SCI 171
UNIX System Security
3 UNITS- (CSU)

Lecture 2 hours. Laboratory 2 hours.
Prerequisite: CO SCI 168.

Covers both theoretical and practical aspects of UNIX system security, including UNIX password systems, file system hardening, cryptography basics, physical security for hardware, protocol security, network authentication methods, secure programming and account defense.

CO SCI 181
Computer Networking – CISCO I
3 UNITS - (CSU)

Lecture 2 hours. Laboratory 3 hours.
Prerequisites: CO SCI 101 or 103 with a satisfactory grade or better or equivalent.

This course covers fundamentals of computer networking. Topics include evolution of networking, seven layers of the OSI reference model, and networking devices such as bridges, hubs, switches, and routers. Internet protocol, IP addressing, subnetting, network topology, and cabling will also be covered.

CO SCI 182
Computer Networking – CISCO II
3 UNITS - (CSU)

Lecture 2 hours. Laboratory 2 hours.
Prerequisite: CO SCI 181 with a satisfactory grade or better or equivalent.

The students learn a wide range of networking fundamentals. Topics include router fundamentals, router setup and configuration, network management, routing and routed protocols, and network troubleshooting.

CO SCI 183
Computer Networking III - CISCO
1.5 UNITS - (A)

Lecture 1 hour. Laboratory 1.5 hours.
Prerequisite: CO SCI 182 with a satisfactory grade or better or equivalent.

The students learn router configuration for various industry standard protocols. Topics include segmentation of LAN's using bridges, routers and switches. Virtual LANs(Local Area Network), Fast Ethernet, cut-through and store-and-forward LAN switching are also discussed.

CO SCI 184
Computer Networking IV - CISCO
1.5 UNITS - (A)

Lecture 1 hour. Laboratory 1.5 hours.
Prerequisite: CO SCI 183 with a satisfactory grade or better or equivalent.

Students learn how to design and configure a Wide Area Network. Various techniques and terms used to configure wide area network include Frame Relay, ISDN (type of a network connection), and POINT to POINT protocol are discussed.

CO SCI 185
Directed Study – CO SCI
1 UNIT

Lecture 1 hour.
Allows students to pursue Directed Study on a contract basis under the direction of a supervising instructor.

CO SCI 186
Introduction to Oracle: SQL and PL/SQL
3 UNITS - (A) (CSU)

Lecture 2 hours. Laboratory 3 hours.
The student learns the concepts of both relational and object relational databases and the SQL language. Students learn about data server technology and how to create and maintain database objects and how to store, retrieve, and manipulate data.

CO SCI 187
Oracle DBA (Database Administration) Part 1A: Architecture and Administration
3 UNITS - (A)

Lecture 2 hours. Laboratory 3 hours.
Prerequisite: CO SCI 186 with a satisfactory grade or better or equivalent.

The student receives a firm foundation in basic administrative tasks and the necessary knowledge and skills to set up, maintain, and troubleshoot an oracle database. The students learn to use an administration tool to startup and shutdown a database, manage file and database storage, and manage users and their privileges.

CO SCI 188**Oracle DBA (Database Administration) Part 1B: Backup and Recovery**
3 UNITS - (A)*Lecture 2 hours. Laboratory 3 hours.**Prerequisite: CO SCI 187 with a satisfactory grade or better or equivalent.*

This course focuses on planning and implementing database backup and recovery strategies. The class addresses backup and recovery techniques and examines various database backup, failure, restore and recovery scenarios. In hands-on exercises, students examine backup methodologies based on mission critical requirements of business enterprises.

CO SCI 189**Oracle DBA (Database Administration) Part 2: Performance and Tuning**
3 UNITS - (A)*Lecture 2 hours. Laboratory 3 hours.**Prerequisite: CO SCI 187 with a satisfactory grade or better or equivalent.*

This course will introduce students to a series of tuning steps, which can be used to improve the performance of the Oracle Server. The focus is on database rather than specific operating system performance issues. Using a variety of tools, students also learn how to recognize, troubleshoot and resolve common performance related problems in administering an Oracle database.

CO SCI 191

Programming Laboratory ARCHIVED

1 UNIT - (RPT 3) (A)

CO SCI 192

Programming Laboratory ARCHIVED

1 UNIT - (RPT 3) (A)

CO SCI 195 ARCHIVED

Computer Networking V:CCNP Cisco Networking Academy Program, Advanced Routing Corrections Institutions

3 UNITS - (A)

CO SCI 196 ARCHIVED

Computer Networking VI:CCNP Cisco Networking Academy Program, Remote Access

3 UNITS - (A)

CO SCI 197 ARCHIVED

Computer Networking VII: CCNP Cisco networking Academy Program, Switching

3 UNITS - (A)

CO SCI 198**PL/SQL Programming for Oracle**
3 UNITS - (A)*Lecture 2 hours. Laboratory 3 hours.**Prerequisite: CO SCI 186 with a satisfactory grade or better or equivalent.*

The Oracle PL/SQL language provides for programming logic features not contained within SQL. The grammar, .syntax and benefits of using the PL/ SQL language within an Oracle database environment are considered. Create and manage user defined packages and Oracle supplied packages. Create functions and procedures to encapsulate business functionality. Enables skills to sit for Oracle Developer Certification.

CO SCI 199**Oracle Forms and Reports**
3 UNITS - (A)*Lecture 2 hours. Laboratory 3 hours.**Prerequisite: CO SCI 198 with a satisfactory grade or better or equivalent.*

To enable the creation, manipulation, extraction of data from an Oracle database using the Oracle Forms & Reports Interfaces. The course takes you through creating basic forms and reports and enhancing them to create the basis of complex applications incorporating formatting techniques and images, logos and objects. This course will enable the student to take the Oracle developers exam.

CO SCI 285**Directed Study – Computer Science Information Technology**
2 UNITS*Lecture 2 hours.*

Allows students to pursue Directed Study on a contract basis under the direction of a supervising instructor.

CO SCI 385**Directed Study – Computer Science Information Technology**
3 UNITS*Lecture 3 hours.*

Allows students to pursue Directed Study on a contract basis under the direction of a supervising instructor.

CORRECTIONS**CORRECTIONS 1****Introduction to Corrections**
3 UNITS – (CSU)*Lecture 3 hours.*

Students learn the nature of the correctional system which includes: the aims and objectives of corrections, probation, institutions, services, supervision of inmates, and career opportunities..

CORRECTIONS 2 ARCHIVED**Corrections Institutions**
3 UNITS – (CSU)**CORRECTIONS 5 ARCHIVED****Legal Aspects of Corrections**
3 UNITS – (A)

DANCE**DANCE SPECIALTIES 440****Social Dance****1 UNIT - (RPT 3) (UC:CSU)***Laboratory 2 hours.*

Students learn basic social dance steps and combinations, terminology, music, and appreciation of dance as an art form.

DANCE SPECIALTIES 459
Flamenco and Spanish Dancing
1 UNIT - (RPT 3) (UC:CSU)

Laboratory 2 hours.

This course introduces the student to flamenco and Spanish dance with an emphasis on correct posture, individual steps, and arm movements. Terminology, various rhythms, basic step combinations and castanet technique will also be covered.

DANCE SPECIALTIES 446
Tap Dance
1 UNIT - (RPT 3) (UC:CSU)

Laboratory 2 hours.

Students learn basic tap dance steps and combinations, terminology, music, and appreciation of dance as an art form.

DANCE STUDIES 185
Directed Study - Dance
1 UNIT - (RPT 3) (UC:CSU)

Laboratory 2 hours.

Allows the student to pursue directed study in dance on a contract basis under the direction of a supervising instructor.

DANCE STUDIES 452
Introduction to Choreography
1 UNIT - (RPT 3) (UC:CSU)

Laboratory 2 hours.

This course introduces students to choreography with an emphasis on basic steps and combinations, creating dances, terminology, music, and appreciation of dance as a performing art form. Course may be taken four times.

DANCE STUDIES 805
History and Appreciation of Dance
3 UNITS - (UC:CSU)

Lecture 3 hours.

Advisory: English 28 and 67.

This course provides a historical perspective of dance from ritual to contemporary theatrical dance forms. It focuses on the ethnic, cultural and ritual forms of dance as it affected and reflected the world in which people lived. Primarily, this course will focus on how Dance reflects the times, historical, social and political climate of the day. The class will consider the impact of dance on the western world and how it has been affected by the different dance traditions world-wide.

DANCE TECHNIQUES 400
Stress Management Techniques
Through Dance and Movement
1 UNIT - (RPT 3) (UC:CSU)

Laboratory 2 hours.

This course helps identify stressors and introduce techniques of dance and dance therapy. Movement mediations, authentic movement studies, breathing exercises, yoga, physical therapy and relaxation exercises are introduced. Multicultural rhythms and dance forms are used to enhance group experiences. May be taken 4 times.

DANCE TECHNIQUES 405 ARCHIVED
 Yoga Conditioning for Dance
 1 UNIT - (RPT 3) (UC:CSU)

DANCE TECHNIQUES 406
Hatha Yoga Conditioning for Dancers
1 UNIT - (RPT 3) (UC:CSU)

Laboratory 2 hours.

Advisory: Dance 405.

This course provides dance students who have attained a basic level of yoga proficiency from Dance 405 (Yoga Conditioning for Dance) access to a more in-depth Hatha yoga practice that offer physical challenges beyond a beginning level and provides more advanced experiences in conditioning, flexibility and endurance to supplement dance technique. Course may be taken four times.

DANCE TECHNIQUES 408 ARCHIVED
 Dance Movement for Instrumentalists and Vocalists
 1 UNIT - (RPT 3) (UC:CSU)

Laboratory 2 hours.

This course will include different music and dance styles, tempo variations, and stage awareness to enhance a music student's movement on stage.

DANCE TECHNIQUES 410 ARCHIVED
 Dance Aerobics
 1 UNIT - (RPT 3) (UC:CSU)

DANCE TECHNIQUES 431
Modern Dance
1 UNIT - (RPT 3) (UC:CSU)

Laboratory 2 hours.

This course introduces students to modern dance with an emphasis on basic steps and combinations, terminology, music, and appreciation of dance as a performing art form. Course may be taken four times.

DANCE TECHNIQUES 434
Ballet
1 UNIT - (RPT 3) (UC:CSU)

Laboratory 2 hours.

This course introduces students to ballet with an emphasis on basic steps and combinations, terminology, music, and appreciation of dance as a performing art form. Course may be taken four times.

DANCE TECHNIQUES 437
Jazz Dance
1 UNIT - (RPT 3) (UC:CSU)

Laboratory 2 hours.

This course introduces students to jazz dance with an emphasis on basic steps and combinations, terminology, music, and appreciation of dance as a performing art form. Course may be taken four times.

DANCE TECHNIQUES 440
Social Dance
1 UNIT - (RPT 3) (UC:CSU)

Laboratory 2 hours.

In each dance form, special attention is paid to technique, terminology, history, style, and appreciation of related arts. Course may be taken four times.

DANCE TECHNIQUES 446
Tap Dance
1 UNIT - (RPT 3) (UC:CSU)

Laboratory 2 hours.

This course introduces students to tap dance with an emphasis on basic steps and combination, terminology, music, and appreciation of dance as a performing art form. Course may be taken four times.

DANCE TECHNIQUES 466**Ballet Combinations****1 UNIT - (RPT 3) (UC:CSU)***Laboratory 2 hours.*

This course introduces students to ballet combinations with an emphasis on basic steps and combinations, terminology, music, and appreciation of dance as a performing art form. Course may be taken four times.

DANCE TECHNIQUES 467**Modern Dance Combinations****1 UNIT - (RPT 3) (UC:CSU)***Laboratory 2 hours.*

This course introduces students to modern dance combinations with an emphasis on basic steps and combinations, terminology, music, and appreciation of dance as a performing art form. Course may be taken four times.

DANCE TECHNIQUES 468**Jazz Dance Combinations****1 UNIT - (RPT 3) (UC:CSU)***Laboratory 2 hours.*

This course introduces students to jazz dance combinations with an emphasis on basic steps and combinations, terminology, music, and appreciation of dance as a performing art form. Course may be taken four times.

DANCE TECHNIQUES 469**Conditioning for Dance****1 UNIT - (RPT 3) (UC:CSU)***Laboratory 2 hours.*

Students will learn dance and aerobic exercises to increase flexibility, strength, and endurance. Course may be taken four times.

DENTAL TECHNOLOGY**DENTAL TECHNOLOGY 100****Introduction to the Dental Laboratory****2 UNITS - (A)***Lecture 1 hour. Lab 3 hours. Open to all college students.*

An Introduction to the modern dental laboratory. Working with gypsum products as well as model and die production are stressed.

DENTAL TECHNOLOGY 101**Elements of Dental Technology****2 UNITS - (A)***Lecture 2 hours.**Advisory: English 21 or equivalent.**Open to all college students.*

Students receive an orientation to the field of dental laboratory technology, including ethics, jurisprudence, history, and categories of training and employment.

DENTAL TECHNOLOGY 102**Dental Anatomy and Terminology****3 UNITS - (A)***Lecture 3 hours.**Advisory: English 21 or equivalent. Open to all college students.*

The students learn about oral cavity and dental terminology,

including morphology and function of primary and secondary human dentition, occlusion concepts and anatomical landmarks. Additionally, the students learn the significance of: skull of osteology, myology and tooth supporting structures histology.

DENTAL TECHNOLOGY 103**Complete Denture Prosthetics I****2 UNITS - (A)***Lecture 3 hours. Laboratory 5 hours.**Prerequisite: Dental Technology 100 (formerly 99C).*

The art and science of creating natural looking complete dentures. This course will include: anatomy, concepts of natural smile, selecting teeth, setting denture teeth, waxing to duplicate natural tissue, processing, finishing, and polishing dentures.

DENTAL TECHNOLOGY 105**Complete Denture Prosthodontics II****2 UNITS - (A)***Lecture 2 hours. Laboratory 2 hours.**Prerequisite: Dental Technology 104 with a satisfactory grade.*

Construction of maxillary and mandibular dentures in balanced occlusion.

DENTAL TECHNOLOGY 106**Dental Materials****3.5 UNITS - (A)***Lecture 3 hours. Laboratory 1 hour.**Prerequisite: Dental Technology 100 (formerly 99C) with a satisfactory grade.*

Study of the physical properties, composition, and uses of dental materials by lecture and demonstration.

DENTAL TECHNOLOGY 108**Gnathological Concepts****3 UNITS - (A)***Lecture 2 hours. Lab 2 hours.**Prerequisite: Dental Technology 109.*

A study of advanced occlusion concepts. Organic waxing of occlusal surfaces will be accomplished on fully adjustable articulators; mandibular tooth carvings will also be completed.

DENTAL TECHNOLOGY 109**Fixed Prosthetics I****4 UNITS - (A)***Lecture 2 hour. Lab 6 hours.**Prerequisite: Dental Technology 100 (formerly 99C) with a satisfactory grade.**Advisory: English 73 or equivalent.*

Waxing anterior and posterior single units by using PTC techniques and methodology based on student learning outcomes. Learning and understanding concepts such as: tooth contour alignment, functional and morphological occlusion. Applied techniques in spruing, investing and metal finish and polish are part of the course outline.

DENTAL TECHNOLOGY 111**Fixed Prosthetics II****5 UNITS - (A)***Lecture 2 hours. Lab 6 hours.**Prerequisite: Dental Technology 109 with a satisfactory grade.*

Waxing single and multiple units by using PTC techniques and methodology based on student learning outcomes. Learning and understanding concepts such as: tooth contour alignment, functional and morphological occlusion. Applied techniques in spruing, investing and casting including soldering, are part of the course outline.

DENTAL TECHNOLOGY 112**Removable Partial Denture Prosthetics I****2 UNITS - (A)***Lecture 2 hours. Laboratory 2 hours.**Prerequisite: Dental Technology 103 with a satisfactory grade.*

An introduction to the study of removable partial denture construction, use of the dental surveyor, design of the partial, waxing and casting techniques.

DENTAL TECHNOLOGY 202**Laboratory Internship****2 UNITS - (A)***Lab 6 hours.**Co-requisite: Dental Technology 207 or 208 with a satisfactory grade.*

Opportunity to observe and work with a skilled dental technician in a dental office, clinic or dental laboratory. Opportunity to apply the knowledge and skills learned in the classroom in a dental office, clinic or dental laboratory for a minimum of 6 hours per week.

DENTAL TECHNOLOGY 203**Metal Ceramic Restorations****2 UNITS - (A)***Lecture 1 hour. Lab 3 hours.**Prerequisite: Dental Technology 206 with a satisfactory grade.*

A course in metal ceramic restorations, including properties, design, manipulation, firing, staining, glazing, polishing, science of color and esthetics; single units and soldered splint porcelain fused to metal.

DENTAL TECHNOLOGY 204**Orthodontics****3 UNITS - (A)***Lecture 2 hours. Lab 2 hours.**Prerequisite: Dental Technology 112 with a satisfactory grade.*

This course goes into the construction and repair of orthodontic and pedodontic appliances. Emphasis will be placed on pouring and trimming orthognathic study casts, wire bending techniques, soldering and welding techniques, and fabrication of various types of orthodontic appliances.

DENTAL TECHNOLOGY 205**Advanced Removable Partial Dentures****10 UNITS***Lecture 4 hours. Laboratory 12 hours.**Prerequisite: Dental Technology 112 and 105.*

This course is the first course for Removable Prosthetic Specialists in Dental Technology Program. This course incorporates advanced removable partial denture design, and manufacturing techniques.

DENTAL TECHNOLOGY 206**Advanced Fixed Prosthetics****10 UNITS***Lecture 4 hours. Laboratory 12 hours.**Prerequisite: Dental Technology 111 and Dental Technology 108*

This course is the first course for Fixed Prosthetic Specialists in the Dental Technology Program. This course incorporates advanced fixed partial denture design, and manufacturing techniques.

DENTAL TECHNOLOGY 207**Advanced Complete Dentures****10 UNITS - (A) (RPT 1)***Lecture 4 hours. Laboratory 12 hours.**Prerequisite: Dental Technology 105 with a satisfactory grade.*

This course is the second course for Removable Prosthetic Specialists in the Dental Technology Program. This course incorporates advanced removable partial denture design and manufacturing techniques.

DENTAL TECHNOLOGY 208**Advanced Ceramic Restorations****10 UNITS - (A) (RPT 1)***Lecture 4 hours. Laboratory 12 hours.**Prerequisite: Dental Technology 206 with a satisfactory grade.*

This course is the second course for Fixed Prosthetic Specialists in the Dental Technology Program. This course incorporates advanced Ceramic Restoration design and manufacturing techniques.

DENTAL TECHNOLOGY UCLA COURSES**MASTER CERAMIST PROGRAM****DENTAL TECHNOLOGY 300****Introduction to Esthetic Dentistry****0.5 UNITS - (A)***Lecture 9 hours. Laboratory 9 hours.**Prerequisite: Dental Technology 109.**Advisory: Dental Technology 108.*

An introduction to using the right side of the brain in order to analyze and execute the waxing of both anterior and posterior teeth. Successful completion of this course allows entry into the Esthetic Dental Design Program.

DENTAL TECHNOLOGY 301**Macro and Micro Esthetics****8 UNITS - (A)***Lecture 4 hours. Laboratory 12 hours.**Prerequisite: Dental Technology 300.**Advisory: Dental Technology 108.*

This course will cover the inter-tooth components of an esthetic smile and the intra-tooth component of an individual tooth.

DENTAL TECHNOLOGY 302**Esthetic Dental Photography Communications & Shade Analysis****3.72 UNITS - (A)***Lecture 2.22 hours. Laboratory 4.45 hours.**Prerequisite: Dental Technology 300.*

A student will learn to master the art and science of dental photography for analysis and communication.

DENTAL TECHNOLOGY 303
Skeleton build-up for Porcelain Fused to Metal
5 UNITS - (A)

Lecture 4 hours. Laboratory 4 hours.
Prerequisite: Dental Technology 300.

This course will focus on the design and fabrication of Composite Metal single and multiple unit substructures and the skeleton build-up technique in porcelain to complete these dental esthetic restorations.

DENTAL TECHNOLOGY 304
Skeleton build-up for All Ceramic Restorations
8 UNITS - (A)

Lecture 4 hours. Laboratory 12 hours.
Prerequisite: Dental Technology 300.

This course will focus on the design and fabrication of All-Ceramic single and multiple unit restorative substructures and the skeleton build-up porcelain technique to complete dental esthetic restorations.

DENTAL TECHNOLOGY 305
Skeleton build-up for Pressable Ceramic Restorations
8 UNITS - (A)

Lecture 4 hours. Laboratory 12 hours.
Prerequisite: Dental Technology 300.

This course will focus on the design and fabrication of Pressable-Ceramic single and multiple unit restorative substructures and the skeleton build-up porcelain technique to complete dental esthetic restorations.

DENTAL TECHNOLOGY 306
Prototypes and Indirect Composite Restorations
12 UNITS - (A)

Lecture 6 hours. Laboratory 18 hours.
Prerequisite: Dental Technology 300 and 301.

This course explores multiple techniques in making esthetic temporary and permanent restorations.

DENTAL TECHNOLOGY 307
Shade Analysis
2 UNITS - (A)

Lecture 1 hours. Laboratory 4.33 hours.
Prerequisite: Dental Technology 300 and 301.

The different zones of individual teeth are analyzed and mapped using both visual and computer generated techniques to create a guide for fabricating a dental restoration.

DENTAL TECHNOLOGY 308
Skeleton Build-up for Laminate Veneers
4 UNITS - (A)

Lecture 1.30 hours. Laboratory 9.77 hours.
Prerequisite: Dental Technology 304.

This course will focus on the design and fabrication of Laminate Veneer single and multiple unit substructures and the skeleton build-up technique in porcelain to complete these dental esthetic restorations.

DENTAL TECHNOLOGY 309
Live-Patient Course II
20.5 UNITS - (A)

Lecture 5 hours. Laboratory 46.8 hours.
Prerequisite: Dental Technology 304.

Students learn to interact with patients for shade analysis and establishing tooth contour for actual dental restorations. Students then fabricate and custom-contour a dental restorations for placement in the patients' mouth.

DENTAL TECHNOLOGY 310
Dental Laboratory Management Internship
11 UNITS - (A)

Lecture 11.66 hours.
Prerequisite: Dental Technology 300.

This course covers basic principles needed to maintain budget, marketing, work-flow, dentist/technician and technician/patient relations.

**ADVANCED PROSTHODONTICS,
 Implants and Maxillofacial PROGRAM**

DENTAL TECHNOLOGY 401
(pending state approval)
Introduction to Advanced Prosthodontics
7.5 UNITS

Lecture 4 hours. Laboratory 11 hours.
Prerequisite: Dental Technology 102 and 106.

This course will cover the dental terminology, materials and morphology necessary to the advance dental technician. Use of the computer in the dental laboratory will also be covered.

DENTAL TECHNOLOGY 402
(pending state approval)
Advanced Prosthodontics 1
16.5 UNITS

Lecture 5 hours. Laboratory 35 hours.
Prerequisite: Dental Technology 401.

This course includes lecture and laboratory in planning and fabrication of advanced implant, fixed and removable prosthodontics and dental ceramics.

DENTAL TECHNOLOGY 403
(pending state approval)
Advanced Prosthodontics 2
6 UNITS

Lecture 3 hours. Laboratory 8 hours.
Prerequisite: Dental Technology 402.

This course includes lecture and laboratory in planning and fabrication of advanced multi-unit full month reconstruction dental ceramics.

DENTAL TECHNOLOGY 404
(pending state approval)
Advanced Prosthodontics 3
16.5 UNITS

Lecture 6 hours. Laboratory 35 hours.

This course includes lecture and laboratory in planning and fabrication of advanced implant, fixed, removable prosthodontics and maxillofacial appliances using hybrid materials and precision attachments.



EARTH SCIENCE

TRANSFER INFORMATION:

Physical Science Requirement: Earth Science 1, Geography 1, Geography 3, Geology 1, Meteorology 3, and Oceanography 1 each satisfy the IGETC and CSU general education requirements for physical science.

Physical Science with Lab Requirement: Geography 1 taken with Geography 15 and Geology 1 taken with Geology 6 both satisfy the IGETC and CSU general education requirements for a physical science with a laboratory.

Social & Behavioral Science Requirement: Geography 2 satisfies the IGETC and CSU social and behavioral sciences requirement.

EARTH SCIENCE 1 Earth Science 3 UNITS – (UC:CSU)

Lecture 3 hours.

Advisory: English 28 and 67 or equivalent.

The student receives a general introduction to the study of the earth's rocks, landforms, atmosphere, and oceans. The student learns interrelationships between the land, atmosphere, and ocean and relates these subjects to global climate change.

ECONOMICS

ECONOMICS 1 Principles of Economics I 3 UNITS – (UC:CSU)

Lecture 3 hours.

Advisory: English 28 and 67 or equivalent.

A course in microeconomics introducing the principles and methods of economic analysis, economic institutions, and issues of economic policy. Emphasis is placed upon production and the allocation of economic resources, and distribution of income through the private enterprise price system.

ECONOMICS 2 Principles of Economics II 3 UNITS – (UC:CSU)

Lecture 3 hours.

Advisory: English 28 and 67 or equivalent.

A course in macroeconomics emphasizing aggregative economic analysis, including money and banking, national income determination, business fluctuations, and other topics relevant to macroeconomic analysis.

EDUCATION

EDUCATION 100 Learning Strategies for College Success 3 UNITS – (CSU)

Lecture 3 hours.

A comprehensive student success course designed to help students master effective academic strategies, to develop the ability to monitor, evaluate, and adjust their approach to the learning process, and to promote and understanding of human diversity in order to enhance overall student success at LACC. The course creates opportunities for students to become self-managed, effective communicators and a successful part of the campus community.

EDUCATION 203 Education in American Society 3 UNITS – (CSU)

Lecture 3 hours.

The course is designed to provide future teachers with the fundamental knowledge essential for understanding the American educational enterprise. Concepts and methods from the fields of sociology, philosophy, and the politics of education are used to analyze the current conditions of urban schools and to evaluate selected proposals/models for reform. A minimum of 20 hours of observation and participation in a multicultural setting is required.

EDUCATION 185 DIRECTED STUDY – 1 UNIT

Lecture 1 hour.

EDUCATION 285 DIRECTED STUDY – 2 UNITS

Lecture 2 hours.

EDUCATION 385 DIRECTED STUDY – 3 UNITS

Lecture 3 hours.

Students pursue on their own an in-depth study of a subject of special interest in the field of Education. Consultation with the instructor on a weekly basis, plus independent work is required.

ELECTRONICS

ELECTRONICS 2 Introduction to Electronics and Computer Technology 3 UNITS - (CSU)

Lecture 2 hours. Laboratory 2 hours.

Students learn the basic concepts of electricity and applications of simple electronic components through introduction to the technological implications of electronics. The laboratory emphasizes skills in breadboarding and soldering and hands-on exposure to basic electronic principles.

ELECTRONICS 4
Fundamentals of Electronics I
4 UNITS - (CSU)

Lecture 3 hours. Laboratory 3 hours.
Co-requisite: Electronics 10.

Students learn the concepts of direct current circuits, including basics of electricity, series and parallel circuits, meters, batteries, resistors, and magnetism. The laboratory emphasizes skills in the analysis of circuits and the use of test equipment.

ELECTRONICS 6
Fundamentals of Electronics II
4 UNITS - (CSU)

Lecture 3 hours. Laboratory 3 hours.
Prerequisite: Electronics 4 with satisfactory grade or better or equivalent.
Co-requisite: Electronics 12.

The student receives a detailed study of alternating current theory and applications, including reactance, impedance, resonance, transformers, coupling, filters, bandpass, and time constants. The laboratory emphasizes skills in the use of test equipment in AC circuits.

ELECTRONICS 8
Electron Devices
4 UNITS - (CSU)

Lecture 3 hours. Laboratory 3 hours.
Prerequisite: Electronics 4 with satisfactory grade or better or equivalent.

The student learns the nature and operation of solid state devices including diodes, transistors, and field effect devices. Includes simple circuit applications.

ELECTRONICS 10
Mathematics of Electronics I
3 UNITS - (CSU)

Lecture 3 hours.
 The student learns mathematical methods and techniques for the solution of basic DC circuit problems including the study of algebraic operations, simple linear equations, algebraic fractions, ratio and percent, graphing, and use of the electronic calculator.

ELECTRONICS 12
Mathematics of Electronics II
3 UNITS - (CSU)

Lecture 3 hours.
Perquisite: Electronics 10 with satisfactory grade or better or equivalent.

Students develop skills in the use of algebra, trigonometry, complex numbers, logarithms, and determinants as needed in electronics calculations. Techniques of network solutions including Kirchhoff's and Ohm's laws and Thevenin's and Norton's theorems are emphasized.

ELECTRONICS 20
Electronics Circuits I
4 UNITS - (CSU)

Lecture 3 hours. Laboratory 3 hours.
Prerequisite: Electronics 6 and 8 with satisfactory grades or better or equivalent.

The students learn the applications of electronic devices such as diodes, junction and FET transistors, MOSFET's, SCR's, to circuits such as signal and power amplifiers, multi-stage amplifiers, differential amplifiers, and special controller circuits. They solve circuit analysis problems with breadboards and computer simulations in the electronics laboratory.

ELECTRONICS 22
Electronics Circuits II
4 UNITS - (CSU)

Lecture 3 hours. Laboratory 3 hours.
Prerequisite: Electronics 6 and 8 with satisfactory grades or equivalent

Introduces the concepts of electronics systems by examining details of AM and FM radio communications, circuits, and theory. Includes radio frequency propagation, transmission line theory, antenna theory, and generation and detection of radio waves. The techniques of scientific trouble shooting are included.

ELECTRONICS 24
Electronics Circuits III
4 UNITS - (CSU)

Lecture 3 hours. Laboratory 3 hours.
Prerequisite: Electronics 20 and 22 with satisfactory grades or better or equivalent.

Extends the study of the systems concept into more sophisticated electronics, including video and television systems. Includes transmission and broadcast of television signals, and digital-analog hybrid systems for audio and video processing and display. The laboratory emphasizes analysis and trouble shooting with the oscilloscope.

ELECTRONICS 48
Integrated Circuits
4 UNITS - (CSU)

Lecture 3 hours. Laboratory 3 hours.
Prerequisite: Electronics 20 with a satisfactory grade or equivalent

Applications of the integrated circuit operational amplifier such as amplifiers, active filters, and oscillators. Includes analog-digital and digital-analog conversion, digital-analog systems integration, and use of operational amplifiers in robotics and environmental sensing.

ELECTRONICS 81
Projects Laboratory
1 UNIT - (RPT 3) (A)

Laboratory 4 hours.
 Course designed to give electronics and computer technology students experience in the following techniques: Identification of devices and components, soldering and desoldering, printed circuit assembling, electronics drafting, and chassis fabrication.

ELECTRONICS 82
Advanced Projects Laboratory
1 UNIT - (CSU) (RPT 2)

Laboratory 3 hours.
Prerequisite: Electronics 81 with a satisfactory grade or equivalent.
Advisory: Electronics 4.

This course amplifies the skills learned in Electronics 81 by applying those skills to more advanced projects. These include enclosure design and development, electronic device integration, industrial applications and computer technology driven systems. Includes basic techniques of circuit board prototyping and production.

ELECTRONICS 87
Technical Documentation
1 UNIT - (CSU) (RPT3)

Laboratory 3 hours.
 Open to all students.

This course addresses the critical topics of technical documentation related to electronics and computer technology. Topics will include report writing, experiment documentation, technical memoranda, proposals, and oral technical presentations. Offered as open entry open exit.

ELECTRONICS 95
Technical Drawing
2 UNITS - (CSU) (RPT1)

Lecture 1 hour. Laboratory 2 hours.

Open to all students. This course covers ANS-Y/4. 1990 Standards for technical drawing. Provides exercises in orthographic drawing, isometric pictorial representation, developments, dimensions, geometric dimensioning and tolerancing (GDT) using a variety of current Computer Aided Design and Drafting applications.

ELECTRONICS 101
Science of Electronics
3 UNITS - (CSU)

Lecture 3 hours.

Advisory: *Electronics 2*

A survey of electronics technology in the context of the principles of science. The application of the methods of Science, Technology, Engineering, and Mathematics (STEM) to topics ranging from basic circuits to complex integrated devices, and the products that use them. Includes topics in electronic music, computers, robotics, digital communication, and a variety of existing technologies. Social, political, and economic impacts of electronic technology are explored.

ELECTRONICS 105
Electrician's Examination
Preparation
6 UNITS - (A)

Lecture 6 hours.

Prepares the student for the "General Journeyman Electrician" Certification examination of the State of California. Reviews electricity principles and fundamentals, installations and services, feeders and branch circuits, grounding and bonding, conductors and cables, Low-voltage circuits and communications, special occupancies, special equipment, motors, power and conditioning equipment, testing/testing equipment, lighting, raceways and boxes, emergency systems, fire detection and alarm systems.

ELECTRONICS 151
Electronics I
5 UNITS - (CSU)

Lecture 3 hours. Laboratory 6 hours.
 Co-requisite: *Electronics 152*.

This course provides the theory and practical hands-on skills required to work with and design fundamental electronic circuits. Topics include Ohm's Law and power formulas, series, parallel, and series-parallel circuits, direct and alternating current circuit analysis, magnetism, and inductance and capacitance. The laboratory provides hands-on training in the design and operation of basic circuits and the use of test equipment.

ELECTRONICS 152
Electronics II
4 UNITS - (CSU)

Lecture 4 hours.

Co-requisite: *Electronics 151 with a satisfactory grade or better. Advisory: Mathematics 115*

This course provides the essential mathematics necessary to support the theory and laboratory practices of Electronics 151. Extensive use of the calculator is emphasized as a tool for quick and accurate computations involved in circuit analysis. Topics include Ohm's Law, circuit formulas, and powers, roots, trigonometric functions, and logarithms as they are applied to electronic circuit problems.

ELECTRONICS 154
Electronics III

6 UNITS - (CSU)

Lecture 4 hours. Laboratory 6 hours.

Prerequisite: *Electronics 151*.

This course provides theory related to and practical applications of semiconductor electronic devices. Topics include atomic theory as it applies to semi-conductors, diodes, and transistors; transistor circuit configurations, operational amplifier theory, and the use of the operational amplifier device in typical electronic and computer circuitry. The laboratory provides hands-on skills in the design and construction of typical circuits and the use of test equipment.

ELECTRONICS 155
Electronics IV

6 UNITS - (CSU)

Lecture 4 hours. Laboratory 6 hours.

Prerequisite: *Electronics 151 with a satisfactory grade or better.*

This course provides instruction in computer logic circuits and microprocessor technology. Topics include Boolean Algebra and computer logic, gates, flip-flops and other circuit elements, the microprocessor as a device, microprocessor system design, and the electronics and programming required to incorporate a microprocessor into a digital or analog system.

ELECTRONICS 155
Electronics V
4 UNITS - (CSU)

Lecture 3 hours. Laboratory 3 hours.

Prerequisite: *Electronics 153*.

This course provides advanced theory related to electronic devices and their analog applications. Topics include oscillators, regulated power supplies, analog-digital and digital-analog converters, introduction to radio frequency theory, modulation, transmission line, antenna, and analog systems as in audio and video analog systems. The laboratory provides hands-on skills in the design, construction, and troubleshooting of typical circuits and the use of test equipment.

ELECTRONICS 156
Electronics VI
4 UNITS - (CSU)

Lecture 3 hours. Laboratory 3 hours.

Prerequisite: *Electronics 154*

This course presents the technology involved in the design and implementation of intelligent machines using top-down systems approach. Topics include programmable logic devices, complex microprocessors, embedded controllers, and input/output devices using microprocessor-based machines. The laboratory involves system design using CAD software, construction of prototypes, and microprocessor programming.

ENGINEERING (ELECTRICAL & GENERAL)

ELECTRICAL ENGINEERING

ELECTRICAL ENGINEERING 220

Electrical Circuits I

4 UNITS - (UC:CSU)

Lecture 3 hours. Laboratory 3 hours.

Prerequisites: Physics 102 with a satisfactory grade or equivalent.

Co-requisite: Mathematics 275.

Students learn the theory of circuit analysis and practice its application to areas of importance in electrical engineering such as DC, AC, operational amplifiers, multi-phase power, and frequency response. Students also perform laboratory exercises to learn how to realize circuit designs using electronic components and to use instruments such as multimeters, oscilloscopes, and signal generators.

GENERAL ENGINEERING

ENGINEERING 101

Introduction to Science, Engineering and Technology

2 UNITS - (UC:CSU)

Lecture 2 hours.

Required of all engineering first semester students. Open to all.

Students learn about the engineering method and strategies for academic and career success in engineering. Students are introduced to mechanical, civil, electrical, and computer systems engineering through project work. The vast range disciplines and opportunities in engineering are presented. Students are guided through challenging design exercises to develop skills in planning, communication, team working, and creativity. Only basic mathematics are required.

ENGINEERING 131

Statics

3 UNITS - (UC:CSU)

Lecture 3 hours.

Prerequisite: Physics 101 with a satisfactory grade or equivalent.

The student learns how to apply vector analysis of forces and moments to determine the equilibrium conditions in trusses, frames, and machines. The course also covers center of mass, centroids, friction, and moment of inertia.

ENGINEERING 151

Materials of Engineering

3 UNITS - (UC:CSU)

Lecture 3 hours.

Prerequisite: Physics 101 and Chemistry 101 with satisfactory grades or better or equivalent.

The student learns how the properties of materials are related to atomic and crystal structure and how processing influences structure and hence properties. Topics include atomic structure and bonding; crystalline structures; phases and phase diagrams; metals; polymers; ceramics; composites; mechanical deformation, fracture, electrical, and magnetic properties.

ENGINEERING 211 ARCHIVED

Computer Augmented Design Techniques I

3 UNITS - (UC:CSU)

ENGINEERING 212

CADD for Engineers II

3 UNITS - (UC:CSU)

Lecture 1 hour. Laboratory 6 hours.

Advisory: Engineering, General 211.

Students develop 3-D representations of engineering components and assemblies using Solidworks feature based parametric solid modeling software. Instruction is given in the types of solid object manipulations that are common to all parametric solid modeling software and used in industry to construct components that can be further combined to make assemblies. The preparation of engineering drawings from the 3-D representation using automation tools is also covered.

ENGINEERING 241

Strength of Materials

3 UNITS - (UC:CSU)

Lecture 2 hours. Laboratory 3 hours.

Prerequisite: Engineering, General 131 with a satisfactory grade or equivalent.

The student learns the application of mechanics to determining the effect of forces and torques on materials. The student will be able to apply this knowledge to the design of load bearing components. The course will cover the following topics: stress, strain, axial loading, torsion, flexural stresses, transverse shear stress, horizontal shear stresses, stress transformations, Mohr's circle, pressure vessels, shear and bending moment diagrams, stresses in a beam, methods of superposition, and elastic strain energy.

ENGLISH

ENGLISH - BASIC SKILLS ENGLISH 20

College Reading Skills

6 UNITS - NDC

Lecture 6 hours.

Prerequisite: Appropriate score on the English Placement Exam

Students receive instruction in techniques of writing clear, coherent compositions and improvement in reading skills which reinforce writing skills necessary for academic success.

ENGLISH 21

English Fundamentals

3 UNITS - NDC

Lecture 3 hours.

Prerequisite: English 20, ESL 6A, or appropriate placement score.

Co-requisite: English 67.

Introduction to English fundamentals, focusing on basic grammar, reading, and writing skills with additional individual tutoring and writing practice in the Writing Center of the English/ESL Department.

ENGLISH 28
Intermediate Reading and Composition
3 UNITS – (A)

Lecture 3 hours.

Prerequisite: ESL 6A or English 21 or 73 or equivalent or appropriate placement score.

Co-requisite: English 67.

Students receive instruction in technique of writing at the college level. Students develop writing and reading skills, with emphasis on grammar, various essay writing, and analysis of fiction and non-fiction materials.

ENGLISH 31
Composition and Critical Reading
5 UNITS – (A)

Lecture 5 hours.

Prerequisite: ESL 6A or English 21 or 97 or appropriate placement score. Advisory: English 68.

Students receive intensive practice in reading, critical thinking and writing skills needed for college transfer courses on the job.

ENGLISH 33 ARCHIVED
 Basic Vocabulary
 3 UNITS – NDC

ENGLISH 46
Reading and Study Improvement
3 UNITS – NDC

Lecture 3 hours.

Students develop reading versatility and efficiency, rapid reading skills, skimming skills, critical reading skills and study skills. Students receive preparations to read materials used in college level courses.

ENGLISH 47 ARCHIVED
 Reading Clinic
 3 UNITS – (RPT 1) NDC

ENGLISH 67
Writing Laboratory
0.5 UNITS – (RPT 3) NDC

Laboratory 1 hour.

Individual help in improving college writing; organization, clarity, and mechanics.

Note: English 21 students are required to take English 67.

ENGLISH 68 ARCHIVED
 Reading Laboratory
 0.5 UNITS – (RPT 3) NDC

ENGLISH 69
Writing and Revising on the Computer
1 UNIT – (RPT 3) NDC

Laboratory 2 hours.

English 69 is designed to supplement and enhance learning in intermediate writing composition and reading courses by providing individualized tutorial and self-help assistance, computers, online resources, and other resource materials that enhance students' critical reading, writing, and computer skills necessary for success in college, career, and vocations.

ENGLISH 73 ARCHIVED
 Beginning College Reading and Writing
 3 UNITS

ENGLISH 78
Writing Memoir
3 UNITS – (RPT 2) (A)

Lecture 3 hours.

Advisory: English 21, Eligibility for English 21, English 97, ESL 6A, or equivalent.

Students read full-length memoirs by published writers and outline and compose their own memoirs.

ENGLISH 94
Intensive Grammar Review
3 UNITS – NDC

Lecture 3 hours.

Advisory: English 21 and 67.

Students engage in an intensive review of grammar and sentence structure to better prepare them for English 28 or 101.

ENGLISH 97
Introduction to College English and Reading Skills
6 UNITS

Lecture 6 hours.

Prerequisite: English 20 or Appropriate placement score.

Advisory: English 47 or English 67.

Students will be introduced to English fundamentals in formal academic writing, focusing on basic grammar, reading, and writing skills. There will also be an introduction to English grammar, college vocabulary, and academic writing skills as well as instruction in comprehending expository articles, narratives, and college-level textbook material.

UNIVERSITY TRANSFER COURSES

ENGLISH 101
College Reading and Composition I
3 UNITS - (UC:CSU)

Lecture 3 hours.

Prerequisite: English 67 and 28 or 31 or appropriate placement score.

Students develop proficiency in college-level reading and writing through the practice of critical thinking and well-developed, logical expository writing.

ENGLISH 102
College Reading and Composition II
3 UNITS - (UC:CSU)

Lecture 3 hours.

Prerequisite: of English 101 or equivalent.

Students study literature and literary criticism in order to develop critical thinking, reading and writing skills beyond the level achieved in English 101, emphasizing logical reasoning, analysis, and strategies of argumentation.

ENGLISH 103
Composition and Critical Thinking
3 UNITS - (UC:CSU)

Lecture 3 hours.

Prerequisite: English 101 or equivalent.

Students develop logic, argumentative and analytical thinking through the examination of written and other types of cultural texts.

ENGLISH 108
Writing Workshop
0.50 UNITS (RPT 3) - (CSU)
Laboratory 1 hour.

English 108 is a supplemental laboratory course for students enrolled in English 101, 102, or 103. Students receive additional instruction in writing college-level essays. Research techniques, proper citation, and strategies in organizing, supporting and revising written assignments are reviewed.

ENGLISH 124
Short Story Writing I
3 UNITS - (UC:CSU)
Lecture 3 hours.

Prerequisite: English 101 or equivalent.

Students develop the skills in the writing or short fiction, focusing on character, narrative development, voice, style, and revision.

ENGLISH 127
Creative Writing
3 UNITS - (UC:CSU)
Lecture 3 hours.

Prerequisite: English 101 or equivalent.

Students receive blocks of intensive training in writing poetry, prose fiction, and/or playwriting. Students compose works that are discussed as part of instruction, supplemented by examples of published writers and theoretical essays on the creative process.

ENGLISH 137 ARCHIVED
 Library Research and Bibliography
 1 UNITS - (UC:CSU)

ENGLISH 185 ARCHIVED
 Directed Study - English
 1 UNIT

ENGLISH 203
World Literature I (beginnings to 1600)
3 UNITS - (UC:CSU)

Lecture 3 hours.

Prerequisite: English 101 or equivalent.

A reading of key literary works and ideas of the Western world, the Middle East, Africa, and Asia from antiquity to the seventeenth century. The course will require students to recognize and compare readings from different cultures and poetic forms and literary themes significant to the cultures in reasoned analysis.

ENGLISH 204
World Literature II (1600 to the present)
3 UNITS - (UC:CSU)

Lecture 3 hours.

Prerequisite: English 101 or equivalent.

Study of selected major works of World literature, covering Western Europe, the Middle East, Africa, and Asia, from the 17th century to the present. The course will require students to recognize and compare readings from different cultures and analyze poetic forms and literary themes significant to the cultures in reasoned analyses.

ENGLISH 205
English Literature I
(Beginnings to 1800)
3 UNITS - (UC:CSU)

Lecture 3 hours.

Prerequisite: English 102 or equivalent.

Students read, discuss and analyze major works of English literature from the beginnings to the late eighteenth century,

to develop an understanding and appreciation of the poetry, fiction, and drama of these literary periods and to express that appreciation in reasoned analyses.

ENGLISH 206
English Literature II:
Nineteenth Century to the Present
3 UNITS - (UC:CSU)

Lecture 3 hours.

Prerequisite: English 102 or equivalent.

Students read, discuss and analyze major works of English literature from the nineteenth century to the present, to develop an understanding and appreciation of the poetry, fiction, and drama of these literary periods and to express that appreciation in reasoned analyses.

ENGLISH 208
American Literature II:
Nineteenth Century to the Present
3 UNITS - (UC:CSU)

Lecture 3 hours.

Prerequisite: English 101 or equivalent.

Students read, discuss and analyze major American literature from the Civil War Period to the present, in order to understand, appreciate, investigate multicultural influences within national identity. Students read works by Mark Twain, Kate Chopin, Robert Frost, Wallace Stevens, Langston Hughes, William Faulkner, Zora Neale Hurston, Leslie Marmon Silko, Tomas Rivera, Bharati Mukerjee, Allen Ginsberg and others.

ENGLISH 211
Fiction
3 UNITS - (UC:CSU)

Lecture 3 hours.

Prerequisite: English 101 or equivalent.

Students read, discuss, and analyze selected short stories and novels written in, or translated into, English from a diversity of cultures and countries to increase students' understanding and appreciation of the art and craft of fiction writing.

ENGLISH 212
Poetry
3 UNITS - (UC:CSU)

Lecture 3 hours.

Prerequisite: English 101 or equivalent.

Students study works by selected poets and background for appreciation of the poetic form, including early verses to 20th and 21st centuries' poetry.

ENGLISH 214
Contemporary Literature
3 UNITS - (UC:CSU)

Lecture 3 hours.

Prerequisite: English 101 or equivalent.

Students read key literary works and ideas of the recent mainstream and ethnically diverse literature to develop understanding and appreciation of contemporary culture, through reasoned analyses of its literature.

ENGLISH 215
Shakespeare I
3 UNITS - (UC:CSU)

Lecture 3 hours.

Prerequisite: English 101 or equivalent.

Shakespeare's sonnets and selected comedies, histories, and tragedies are read to develop an understanding and appreciation of these literary forms. Works selected in this class will differ from those used in English 216.

ENGLISH 216
Shakespeare II
3 UNITS - (UC:CSU)

Lecture 3 hours.

Prerequisite: English 101 or equivalent.

Students continue to study Shakespeare's poetry, theater and drama with a selection of different works of Shakespeare than those used in English 215.

ENGLISH 218
Children's Literature
3 UNITS - (CSU)

Lecture 3 hours.

Prerequisite: English 101 or equivalent.

Students use critical analysis of the various ethnic American writers who straddle two or more cultures, analyzing in terms of assimilation, acculturation, double and mestiza consciousness and wholeness.

ENGLISH 219
The Literature of American Ethnic Groups
3 UNITS - (UC:CSU)

Lecture 3 hours. Laboratory 3 hours.

Prerequisite: English 101 or equivalent.

English 219 offers a critical analysis of the various ethnic American writers who straddle two or more cultures. The diversity of conflicting perspectives in novel, autobiography, essay, and poetry will be read and analyzed in the context of how these writers have defined or challenged concepts of identity, society, and power in past and contemporary American cultures. Literary works by African-American, American-Indian, Asian-American, Arab-American, Chicano/Latino, and Euro-American writers will be analyzed in terms of assimilation, acculturation, double and mestiza consciousness, and wholeness.

ENGLISH 239
Women in Literature
3 UNITS - (UC:CSU)

Lecture 3 hours.

Prerequisite: English 101 or equivalent.

Students study and analyze a survey of literature in English, including prose fiction, poetry, autobiography and essays, written by women, with an emphasis on writers of the 20th century.

ENGLISH 240
Literature and the Motion Picture I
3 UNITS - (UC:CSU)

Lecture 3 hours.

Prerequisite: English 101 or equivalent.

Students analyze and evaluate films of artistic and cultural significance, comparing the language, structure, and narrative techniques of film and literary classics by reading literature and watching films based on these literary sources.

ENGLISH 252
The English Bible as Literature
3 UNITS - (UC:CSU)

Lecture 3 hours.

Prerequisite: English 101 or equivalent.

Students study the principle achievements of the Hebrew and Greek Testaments, using the Oxford Annotated Text as the basic text, to note literary and cultural influences.

ENGLISH COURSE SEQUENCE

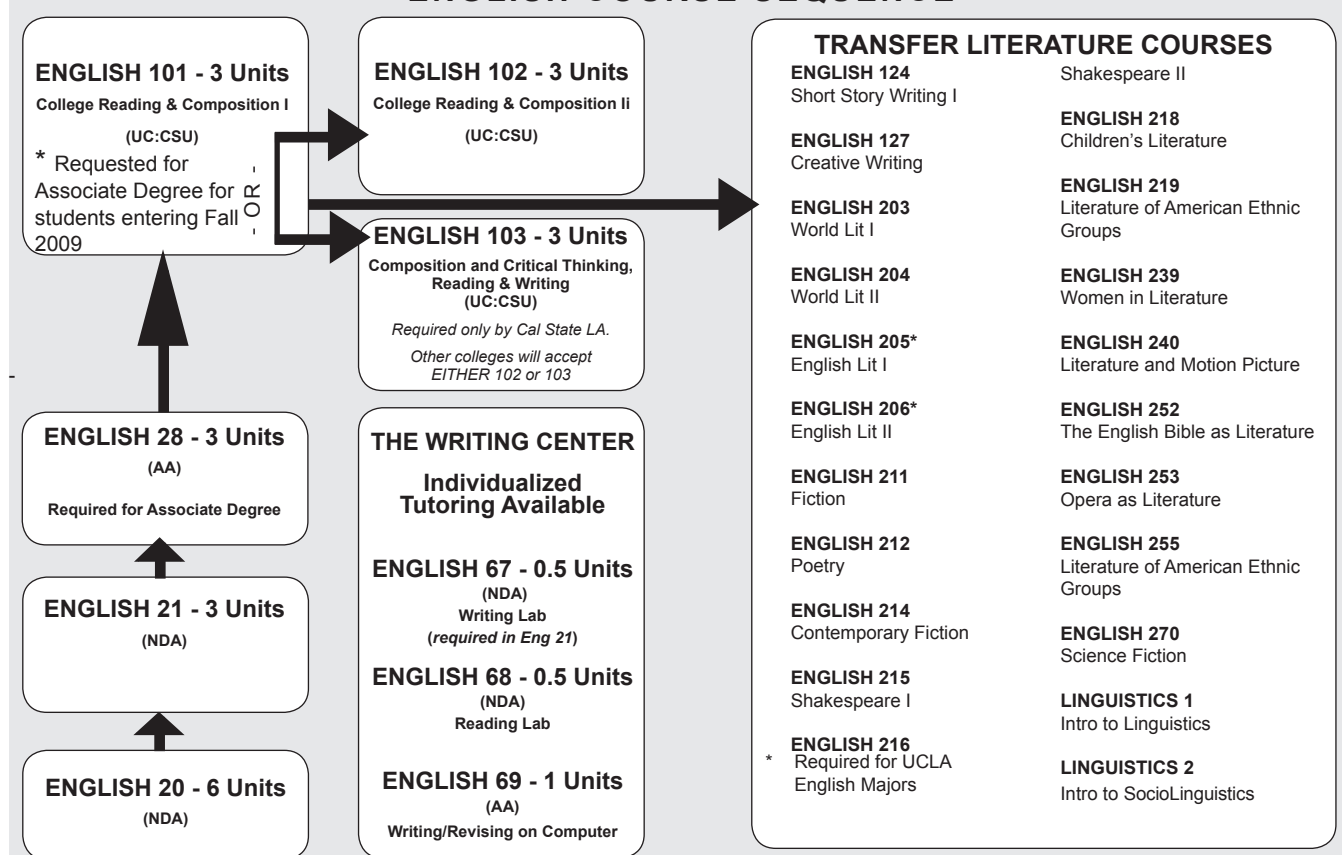

ENGLISH 253
Opera as Literature
3 UNITS - (UC:CSU)

Lecture 3 hours.

Prerequisite: English 101.

This course will study a selection of significant literary works that have been made into operas analyzing both the cultures in which they were created and how the interactions of music and drama transform or realize each literary work. Readings will include selected poems, plays, and fiction. Among the operas will be works by Purcell, Mozart, Puccini, Wagner, Verdi, and Britten.

ENGLISH 255
Latin American Literature
3 UNITS - (UC:CSU)

Lecture 3 hours.

Prerequisite: English 101.

This course will study a selection of significant literary works by Latin American authors. Readings will include selected poems, plays, and fiction by writers such as Pablo Neruda, Galeano, and Jorge Luis Borges, and will explore the themes of magical realism, social engagement, "la raza cosmica," and utopian yearnings.

ENGLISH 270
Science Fiction - Fantasy
3 UNITS (UC:CSU)

Lecture 3 hours.

Prerequisite: English 101, *Appropriate score on the English Placement Exam or equivalent.*

Students read and study works of science fiction, with an emphasis on the use of mythology, science fiction by scientists and non-scientists, philosophically oriented science fiction, and science fiction as fantasy and escape literature.

ENGLISH 185
Directed Study — English
1 UNIT (CSU) (RPT 2)

ENGLISH 285
Directed Study — English
2 UNIT (CSU)

Lecture 2 hours.

ENGLISH 385
Directed Study — English
3 UNITS (CSU)

Prerequisite: Approval of proposed project. See Department Chair.

Students pursue directed study in literary analysis, a particular genre or period, or independent research on a contract basis under the direction of a supervising instructor.

A maximum of 3 units in Directed Study may be taken for credit.

ESL COURSE SEQUENCE

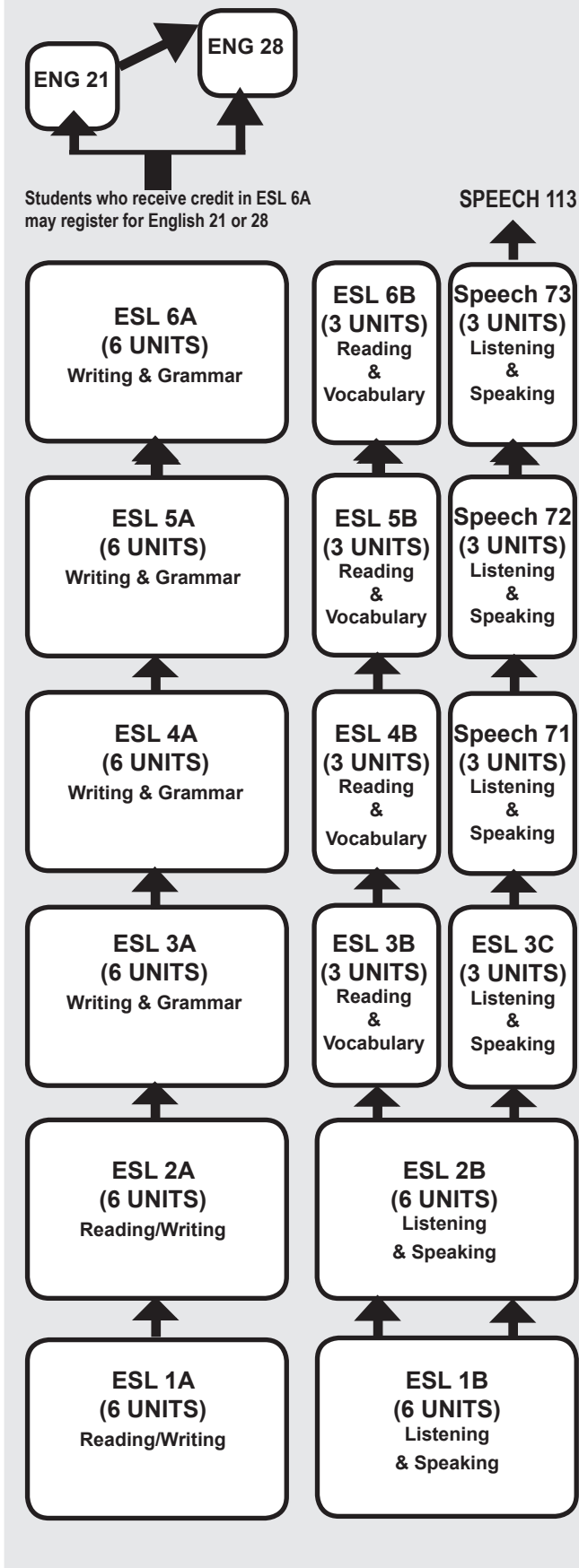

COLLEGE ENGLISH AS A SECOND LANGUAGE

ESL 1A Integrated Skills: Reading and Writing 6 UNITS - NDC

Lecture 6 hours.

Prerequisite: Appropriate placement score.

Advisory: ESL 1B.

(Credit/No Credit)

Students in the low beginning ESL level receive instruction to develop basic grammar, reading and writing skills needed for college work.

ESL 1B Integrated Skills: Listening and Speaking 6 UNITS - NDC

Lecture 6 hours.

Prerequisite: Appropriate placement score. Advisory: ESL 1A.

(Credit/No Credit)

Students at the low beginning ESL level learn skills in listening and speaking to prepare them for college work.

ESL 2A Integrated Skills: Reading and Writing 6 UNITS - NDC

Lecture 6 hours.

Prerequisite: ESL 1A or appropriate score on the ESL placement assessment.

Advisory: ESL 2B.

(Credit/No Credit)

Students in the high beginning ESL level receive instruction to develop basic grammar, reading and writing skills needed for college work.

ESL 2B Integrated Skills: Listening and Speaking 6 UNITS - NDC

Lecture 6 hours.

Prerequisite: ESL 1B or appropriate score on the ESL placement assessment. Advisory: ESL 2A. (Credit/No Credit)

For beginning ESL students. Emphasis on development of basic speaking and listening for college work.

ESL 3A Writing and Grammar 6 UNITS - NDC

Lecture 6 hours.

Prerequisite: ESL 2A or appropriate score on ESL placement.

Advisory: ESL 3B and ESL 3C. (Credit/No Credit)

Students at the low-intermediate ESL level learn skills in writing and grammar to prepare them for college work.

ESL 3B Reading and Vocabulary 3 UNITS - NDC

Lecture 3 hours.

Prerequisite: ESL 2B or appropriate score on the ESL placement assessment. Advisory: ESL 3A or ESL 3C.

(Credit/No Credit)

Students at the low intermediate ESL level receive instruction in reading and vocabulary skills to prepare them for college work.

ESL 3C Listening and Speaking 3 UNITS - NDC

Lecture 3 hours.

Prerequisite: ESL 2B or appropriate score on the ESL placement assessment. Advisory: ESL 3A and ESL 3B.

(Credit/No Credit)

For low intermediate ESL students. Improves listening and speaking skills to prepare students for college work.

ESL 4A Writing and Grammar 6 UNITS - NDC

Lecture 6 hours.

Prerequisite: Satisfactory completion of ESL 3A or appropriate score on the ESL placement assessment. Advisory: ESL 4B.

(Credit/No Credit)

Students at the high-intermediate ESL level learn skills on improving their writing and grammar to prepare them lower-level college work.

ESL 4B READING AND VOCABULARY 3 UNITS - NDC

Lecture 3 hours.

Prerequisite: Satisfactory completion of ESL 3B or appropriate score on the ESL placement assessment. Advisory: ESL 4A.

(Credit/No Credit)

Students at the high-intermediate ESL level learn skills in reading and vocabulary to prepare them for college work.

ESL 5A Writing and Grammar 6 UNITS - NDC

Lecture 6 hours.

Prerequisite: ESL 4A or appropriate score on the ESL placement assessment. Advisory: ESL 5B. For low advanced ESL students.

Students at the low-advanced ESL level receive instruction on improving their writing skills to prepare them upper-level college work.

ESL 5B Reading and Vocabulary 3 UNITS - NDC

Lecture 3 hours.

Prerequisite: ESL 4B or appropriate score on the ESL placement assessment. Advisory: ESL 5A.

Students at the low advanced ESL level learn skills in reading and vocabulary to prepare them for college work.

ESL 6A Writing and Grammar 6 UNITS - NDC

Prerequisite: ESL 5A or appropriate score on the ESL placement assessment. Advisory: ESL 6B. For advanced students. Improves writing to help prepare students for college work.

ESL 6B Reading and Vocabulary 3 UNITS - NDC

Lecture 3 hours.

Prerequisite: ESL 5B or appropriate score on the ESL placement assessment. Advisory: ESL 6A.

Students at the high-advanced ESL level learn skills in reading and vocabulary to prepare them for college work.

ESL 12 ARCHIVED Writing and Revising on the Computer for ESL Students 1 UNIT - (RPT3) NDC

ENVIRONMENTAL DESIGN

ENVIRONMENTAL DESIGN 101 Foundations of Design I 3 UNITS - (CSU)

Lecture 1 hour ; laboratory 5 hours.

First level architectural design studio. Students develop creative, conceptual and analytical skills by creating simple to complex projects. Learn to properly communicate architectural concepts through drawings, renderings, physical models, and computer 3-D modeling. Fundamental architectural formal and spatial design principles, theories, order and methodologies are explored and incorporated into student projects. The profession of architecture and the practice of architects are clarified. Critical for students interested in pursuing a higher degree in architecture school or related design field. Recommended for all art and interior design related fields. Great also as a general education course to develop the creative mind. Students will also create a portfolio of their work.

ENVIRONMENTAL DESIGN 102 Foundations of Design II 3 UNITS - (CSU)

Lecture 1 hour ; laboratory 5 hours.

Prerequisite: Environmental Design 101 with a satisfactory grade.

Second level architectural design studio. Students continue to develop creative, conceptual and analytical skills by designing more complex projects addressing multiple programmatic requirements, symbolism and contextualism. Drawing, rendering, computer and model making skills are further refined. Students will also create a portfolio of their work.

ENVIRONMENTAL SCIENCE

ENVIRONMENTAL SCIENCE 1 ARCHIVED

The Human Environment: Physical Processes

3 UNITS – (UC:CSU)

Advisory: English 28 and 67 or 31 or equivalent

Lecture 3 hours

FAMILY AND CONSUMER STUDIES

FAMILY AND CONSUMER STUDIES 21 (SAME AS NUTRITION 21)

Nutrition

3 UNITS - (UC: CSU)

Lecture 3 hours.

Co-requisite: English 21 and 67 or equivalent.

Students learn the scientific concepts of Nutrition in a lecture interactive format evaluating how lifestyle, diet, food/nutrition/nutrient excess and deficiencies; phytochemicals; food safety; food technology affect diseases and assessment of

nutrition in human development from conception through maturity. Personal dietary assessment, synthesizing data from computerized dietary program and family tree, appraises nutritional disease risk factors. Students evaluate excesses and deficiencies and construct practices that establish and maintain a healthy lifestyle and result in a healthier mind, healthier nutritional eating practices, enhancing the spirit and nourishing the body.

FAMILY AND CONSUMER STUDIES 24 Food Preparation 3 UNITS - (CSU)

Lecture 2 hours Laboratory 3 hours.

Advisory: English 21 and 67 or equivalent.

Students are introduced to the scientific fundamentals of food preparation in both lecture and laboratory format. Scientific principles of food preparation are emphasized using current technology. The role of food in cultures, nutrition, and the economy are integrated into meal planning and preparation.

FAMILY AND CONSUMER STUDIES 27 Nutrition Care 3 UNITS - (CSU)

Lecture 3 hours.

Prerequisite: Family and Consumer Studies 21, 55, 56 and English 21.

Co-requisite: Family and Consumer Studies 127 required.

Advisory: English 101 and Biology 25.

This course is offered only fall semesters, day session. Nutrition problems of patients with cancer, AIDS, diabetes, cardiovascular diseases, renal diseases, and liver diseases are studied for appropriate menu modifications. The development and implementation of nutrition care plans are emphasized.

FAMILY AND CONSUMER STUDIES 28 Advanced Nutrition Care 3 UNITS - (CSU)

Lecture 3 hours.

Prerequisite: Family and Consumer Studies 27 or equivalent.

Co-requisite: Concurrent enrollment in Family and Consumer Studies 128 required.

This course is offered only spring semesters, day session. Nutritional needs at each stage of the life cycle are studied in depth. Cultural food preferences are studied and incorporated into nutrition education and counseling of clients.

FAMILY AND CONSUMER STUDIES 29 Dietetic Seminar 1 UNIT - (CSU)

Lecture 1 hour.

Prerequisite: Family and Consumer Studies 28 with a satisfactory grade or equivalent.

Co-requisite: Concurrent enrollment in Family and Consumer Studies 129 required.

This course is offered only spring semesters, day session. The role of the dietetic technician in the dietetics profession and health care delivery system is explored.

FAMILY AND CONSUMER STUDIES 31 Marriage and Family Life 3 UNITS - (UC: CSU)

Lecture 3 hours.

Prerequisite: English 21 or 73 or equivalent.

Interpersonal growth and rewarding relationship are explored over the course of the family life cycle. Examines the impact of social, psychological and economic forces that affect the family.

**FAMILY AND CONSUMER STUDIES 50
SANITATION AND SAFETY
3 UNITS - (CSU)**

Lecture 3 hours.

Co-requisite: Concurrent enrollment in English 21 or equivalent. Students learn basic principles of sanitation and safety including the types of microorganisms that cause foodborne illness, foodborne infections, toxin-mediated infection, and intoxication. Class includes discussion of environmental conditions including food hazards, contamination, cross-contamination, time and temperature, and personal food handler practices that cause sanitation/safety risks. US Food Code regulations, California state and Los Angeles County Environmental Health Department regulations and a HACCP system of food safety will help define the role of food, people, and facility in managing a sanitary food facility operation. Emphasis on the importance of proper employee food safety training practices as related to the providing of safe food are core competencies of this class.

**FAMILY AND CONSUMER STUDIES 51
Food Production Management
3 UNITS - (CSU)**

Lecture 3 hours.

Co-requisite: Concurrent enrollment Family and Consumer Studies 151 is required.

Advisory: English 21 or equivalent, Mathematics 105 or Learning Skills 10ABC or higher.

Students can satisfy English and Mathematics requirements by appropriate placement on the College Assessment. This course is offered only fall semesters, day session. Introduction to institutional menu analysis for food requisitioning, food production planning and implementation. Basic principles of quantity cooking are emphasized.

**FAMILY AND CONSUMER STUDIES 52
Food Service Management
3 UNITS - (CSU)**

Lecture 3 hours.

Prerequisite: Family and Consumer Studies 51 and 55.

The student explores and masters the systems approach to food service management including the menu, food purchasing, personnel management, facility management, fiscal management, marketing, and information systems.

**FAMILY AND CONSUMER STUDIES 55
Dietetic Education
3 UNITS - (CSU)**

Lecture 3 hours.

Advisory: English 21 or equivalent.

This course is offered only fall semesters. An introduction to careers in dietetics and school food service. The application of communication skills to training, counseling, and education is studied.

**FAMILY AND CONSUMER STUDIES 56
Nutrition Delivery Systems
3 UNITS - (CSU)**

Lecture 3 hours.

Co-requisite: Family and Consumer Studies 156 required.

Advisories: English 21 or equivalent, and Mathematics 105 or higher, Learning Skills 10ABC or higher.

This course is offered only spring semesters, day session. Introduction to nutrition delivery systems and institutional menu diet modifications. State and Federal regulatory guidelines for food service are studied.

**FAMILY AND CONSUMER STUDIES 27
Nutrition Care Laboratory
2 UNITS - (A)**

Lecture 3 hours.

Prerequisite: Physical examination, negative TB test with the past 6 months, MMR, student malpractice insurance.

Co-requisite: Concurrent enrollment with Family and Consumer Studies 27 required.

This course is offered only fall semesters, day session. This clinical laboratory provides supervised practice in development and implementation of nutrition care plans in acute care facilities.

**FAMILY AND CONSUMER STUDIES 28
Advanced Nutrition Care Laboratory
2 UNITS - (A)**

Laboratory 6 hours.

Prerequisite: Family and Consumer Studies 127, Physical examination, negative TB test within the past 6 months, MMR, student malpractice insurance.

Co-requisite: Family and Consumer Studies 28.

This course is offered only spring semesters, day session. This clinical laboratory provides supervised practice in group education and counseling of clients from various stages of the life cycle.

**FAMILY AND CONSUMER STUDIES 129
Dietetic Laboratory
2 UNITS - (A)**

Prerequisite: Physical examination and negative TB test within the past 6 months, student malpractice insurance; Family and Consumer Studies 151.

Co-requisite: Family and Consumer Studies 29.

This course is offered only spring semesters, day session. This clinical laboratory provides supervised practice in management and marketing of food service facilities.

**FAMILY AND CONSUMER STUDIES 151
Food Production Management Laboratory
2 UNITS - (A)**

Laboratory 5 hours.

Prerequisite: Physical examination and negative TB test within the past 6 months, student malpractice insurance.

Co-requisite: Concurrent enrollment in Family and Consumer Studies 51 required.

This course is offered only fall semesters, day session. Students receive supervised practice in food requisitioning, food production planning, and quantity food production in a clinical laboratory.

**FAMILY AND CONSUMER STUDIES 156
Nutrition Delivery Systems Laboratory
2 UNITS - (A)**

Lecture 5 hours.

Prerequisite: Physical examination and negative TB test within the past 6 months, student malpractice insurance.

Co-requisite: Concurrent enrollment in Family and Consumer Studies 56 required.

This course is offered only spring semesters, day session. This clinical laboratory provides supervised practice in nutritional services including modified diets and the health care team. Nutrition delivery systems are evaluated according to state and federal regulatory guidelines.

FAMILY AND CONSUMER STUDIES 185**Directed Study — Family and Consumer Studies
1 UNIT (CSU)****FAMILY AND CONSUMER STUDIES 285****Directed Study — Family and Consumer Studies
2 UNITS (CSU)****FAMILY AND CONSUMER STUDIES 385****Directed Study — Family and Consumer Studies
3 UNITS (CSU)***Lecture 1 hour per unit.*

Allows students to pursue Directed Study on a contract basis under the direction of a supervising instructor. Refer to the "Directed Study" section of this catalog for additional information.

Credit Limit: A maximum of 3 units in Directed Study may be taken for credit. This course enables Family Consumer Studies students to pursue on their own an in-depth study of a subject of special interest in the field of Family and Consumer Studies. Consultation with the instructor on a weekly basis, plus independent work is required.

FINANCE**FINANCE 2****Investments
3 UNITS - (CSU)***Lecture 3 hours.**Prerequisite: Finance 8 with a satisfactory grade or better.*

The principles of investment, the various types of investments, the operations of investment markets, and sources of information.

FINANCE 8**Personal Finance and Investments
3 UNITS - (CSU)***Lecture 3 hours.**Advisory: English 28 and 67 or equivalent.*

Applying the principles of accounting, banking, finance, office methods, management, and production, to one's personal affairs. Family budgeting, consumer credit, home ownership, life and property insurance, investments and savings plans, social security and retirement plans.

FINANCE 11 ARCHIVED**Credits and Collections
3 UNITS - (CSU)****FINANCE 15****Principles of Banking
3 UNITS - (CSU)***Lecture 3 hours.**Advisory: English 28 and 67 or equivalent.*

This course is designed to provide an understanding of the basic functions of banking and a working knowledge of the operation of a bank.

FRENCH

Transfer limit: UCLA allows no credit for duplication of a foreign language if the student completed in high school the equivalent levels with a satisfactory grade; A.A. Degree.

One year of high school study in French corresponds to one college semester of credit or one semester of French at LACC equals one full year of high school credit.

FRENCH 1**Elementary French I
5 UNITS - (UC:CSU)***Lecture 5 hours.**Advisory: English 28 and 67*

The student learns French pronunciation and grammar, practical vocabulary, useful phrases as well as basic facts on the geography, customs and culture of the French speaking world.

FRENCH 2**Elementary French II
5 UNITS - (UC:CSU)***Lecture 5 hours.**Prerequisite: French 1 with a satisfactory grade or equivalent.*

The student completes the study of elementary French grammar, increases their practical vocabulary, and masters useful phrases. The student reads elementary texts including those that explore basic facts on the geography, customs and culture of the French speaking world.

FRENCH 3**Intermediate French I
5 UNITS - (UC:CSU)***Lecture 5 hours.**Prerequisite: French 2 with a satisfactory grade or equivalent.*

Review of grammar, composition and vocabulary building. Introduction to French and Francophile authors.

FRENCH 4**Intermediate French II
5 UNITS - (UC:CSU)***Lecture 5 hours.**Prerequisite: French 3 with a satisfactory grade or equivalent.*

The student reviews French grammar, composition and vocabulary, and pursues a deeper understanding of French and Francophile authors.

FRENCH 8**Conversational French
2 UNITS - (RPT 3) (UC:CSU)***Lecture 2 hours.**Prerequisite: French 2 with a satisfactory grade or equivalent.*

Oral expression in French is the main thrust of the course. The focus is on conversational skills revolving around everyday situations that a person may encounter when traveling or living in French-speaking countries, or when interacting with French-speaking people in the United States.

UC Limit: maximum units: 2 courses.

FRENCH 10
(SAME AS HUMANITIES 42)
French Civilization
3 UNITS

Lecture 3 hours.

Advisory: English 28 and 67.

Students learn about French culture from before the Romans through the culture of today. The ruling dynasties, various wars and revolutions and their affect on the arts and literature is discussed. Students assess the role of France in Europe and the world.

GEOGRAPHY

GEOGRAPHY 1
Physical Geography
3 UNITS – (UC:CSU)

Lecture 3 hours.

Advisory: English 28 and 67 or equivalent.

Students learn about basic scientific principles of geography such as Earth-Sun relationships, weather and climate, ecosystems and biomes, anthropogenic pollution and climate change, earth's internal structure and processes, and surface topography. Students will also learn basic map reading and geographic literacy.

GEOGRAPHY 2
Cultural Elements of Geography
3 UNITS – (UC:CSU)

Lecture 3 hours

Advisory: English 28 and 67 or equivalent.

Students learn about human cultural variables in the context of the globe, including the description, analysis, and explanation of population, migration, folk and popular culture, language, religion, ethnicity, political geography, development, agriculture, industry, economic activities, urban areas, and resource utilization. Special emphasis is placed on contemporary issues such as the effects of globalization and the impact of human settlements on the natural environment. Students also learn basic geographic literacy and map reading.

GEOGRAPHY 3
(Same as Meteorology 3)
Introduction To Weather and Climate
3 UNITS – (UC:CSU)

Lecture 3 hours

Advisory: English 28 and 67 or equivalent.

Students learn about Earth-Sun relationships, atmospheric composition and structure, energy transfer, temperature, pressure and winds, humidity, clouds and precipitation, stability, storms and severe weather, forecasting, and climate in order to understand weather patterns on local, regional, and global scales. This course also includes a treatment of timely environmental topics such as global warming, ozone hole, El Nino, and air pollution. Same as Meteorology 3.

GEOGRAPHY 15
Physical Geography Laboratory
2 UNITS – (UC:CSU)

Lecture 1 hour. Laboratory 2 hours.

Advisory: English 28 and 67 or equivalent; Geography 1.

Students learn to interpret physical maps, including weather maps and topographic maps, as well as perform hands-on exercises that explore Earth-Sun relationships, atmospheric temperature, pressure and moisture, climate and biomes,

plate tectonics and volcanoes, and landforms.

Note: Geography 15 may be taken concurrently with Geography 1.

GEOLOGY

GEOLOGY 1
Physical Geology
3 UNITS – (UC:CSU)

Lecture 3 hours.

Advisory: English 28 and 67 or equivalent.

In this elementary course, the student learns Earth's internal and external forces and the features that these forces create. Students study minerals, rocks, volcanoes, earthquakes, mountain building, plate tectonics, tsunami, global warming, natural resources, and alternative energy resources.

GEOLOGY 6
Physical Geology Laboratory
2 UNITS – (UC:CSU)

Lecture 1 hour. Laboratory 2 hours.

Advisory: English 28 and 67 or equivalent; Geology 1

In this elementary course the student learns to identify hand samples of minerals and rocks using a hands-on approach. The student also learns to develop topographic and geologic maps in great detail, including changing map scales using dimensional analysis and analyzing aerial photographs.

Note: Geology 6 may be taken concurrently with Geology 1

HEALTH

UC Limit: Health 2, 8, and 11 combined: maximum credit, one course.

HEALTH 2
Health and Fitness
3 UNITS – (UC:CSU)

Lecture 1 hour. Laboratory 2 hours.

Course explores physical fitness as related to cardiovascular capacity, nutrition, stress, and addictive substances. The course involves laboratory assessment of each student's fitness status, lecture, and selected fitness activities. Based on these experiences students develop individualized fitness programs.

HEALTH 3
Cardiopulmonary Resuscitation
1 UNIT - (CSU)

Advisory: English 21/31 or equivalent.

Prepares for American Red Cross National Cardiopulmonary (CPR) certifications. Topics include: rescue breathing, choking, cardiac arrest and distress; recognition and prevention of cardiovascular disease and the community emergency medical services system.

HEALTH 8**Women's Personal Health
3 UNITS - (UC:CSU)***Lecture 3 hours.*

The course examines the personal and social dimensions of women's health and the development of strategies for empowerment in decision making that impact changes and improvement in health welfare.

HEALTH 11**Principles of Healthful Living
3 UNITS - (UC:CSU)***Lecture 3 hours.*

The course offers health related concepts for today and the future as guidelines for a self-directed, responsible, satisfying, and productive life-style. Emphasis is on cognitive concepts and strategies of wellness for the individuals personal community, vocational, and leadership roles.

HISTORY**HISTORY 1****Introduction to Western Civilization I
3 UNITS - (UC:CSU)***Lecture 3 hours.**Advisory: English 28 and 67.*

A study of the main cultural, economic and political trends and events from the rise of civilization in the Near East to the eve of the French Revolution.

HISTORY 2**Introduction to Western Civilization II
3 UNITS - (UC:CSU)***Lecture 3 hours.**Advisory: English 28 and 67.*

A continuation of History I focusing on the period from the French Revolution to the present.

HISTORY 3**History of England and Great Britain I
3 UNITS - (UC[PENDING]:CSU)***Lecture 3 hours.**Advisory: English 101*

The student explores British culture, emphasizing social, political, and economic issues from earliest times to 1500.

HISTORY 4**History of England and Great Britain II
3 UNITS - (UC[PENDING]:CSU)***Lecture 3 hours.**Advisory: English 101*

The student explores British culture, emphasizing social, political, and economic issues from 1500 to the present.

HISTORY 5 ARCHIVED

History of the Americas I

3 UNITS - (UC:CSU)

HISTORY 6 ARCHIVED

History of the Americas II

3 UNITS - (UC:CSU)

HISTORY 8 ARCHIVED

History of the American West

3 UNITS - (UC:CSU)

HISTORY 11**Political and Social History of the United States I
3 UNITS - (UC:CSU)***Lecture 3 hours.**Advisory: English 28 and 67 or equivalent.*

Note: Meets the Associate of Arts degree requirements in U.S. History, U.S. Constitution, and California State and Local Government.

UC limit: Credit allowed for only one of African-American Studies 4 or History11 or Chicano Studies 7.

Students survey the political and social history of the United States from the colonial period through the Civil War and Reconstruction.

HISTORY 12**Political and Social History of the United States II
3 UNITS - (UC:CSU)***Lecture 3 hours.**Advisory: English 28 and 67 or equivalent.*

Note: Meets the Associate of Arts degree requirements in U.S. History, U.S. Constitution, and California State and Local Government. UC limit: Credit allowed for only one of History 12, 13 or African-American

Studies 5, or Chicano Studies 8.

A survey of the political and social history of the United States from the Reconstruction to the 20th Century, including the U.S. Constitution, California State and Local Government.

HISTORY 13**The United States in the Twentieth Century
3 UNITS - (UC:CSU)***Lecture 3 hours.**Advisory: English 28 and 67 /31 or equivalent.*

Note: Meets the Associate of Arts degree requirements in U.S.

The student learns the main events, personalities, and themes of the social and political history of the U.S. in the 20th & 21st Centuries by focusing on their overall impact including a discussion of the country's central institutions. The student identifies, discusses and describes the historical importance of the events of the period in question.

HISTORY 59**Comparative History of Genocide and War Crimes
3 UNITS - (UC:CSU)***Lecture 3 hours.**Advisory: English 28 and 67*

The student learn the comparative history of genocide and war crimes in the 20th century and the legal instruments and organizations that have attempted to criminalize acts that fit within the definitions of genocide under international law. Students will also learn the comparative history of cultural conflict (identity), race & racism, and nationalism.

HISTORY 81
A History of Working People in the United States I
3 UNITS - (UC:CSU)

Lecture 3 hours.

The student learns the history of working people in the United States from the colonial period through Reconstruction. Colonial life, the Revolutionary War, the early republic, the market revolution, the rise of urban America, westward expansion, the Civil War, and Reconstruction are examined from the perspective of indentured servants, slaves, farmers, skilled and unskilled laborers, and male and female workers.

HISTORY 82
A History of Working People in the United States II
3 UNITS - (UC:CSU)

Lecture 3 hours.

The student learns the history of working people in the United States from Reconstruction to the present. Reconstruction, the gilded Age and Progressive Era, immigration, imperialism, the Twenties, the Great Depression and New Deal, the World Wars, the Cold War and the Fifties, the Sixties, the conservative shift, and globalization are examined from the perspective of people from diverse social groups.

HISTORY 86
Introduction to World Civilizations I
3 UNITS - (UC:CSU)

Traces the development and interrelationships of the major world civilizations and their cultural traditions and contributions from the earliest times to the era of European expansion in the sixteenth century.

HISTORY 87
Introduction to World Civilizations II
3 UNITS - (UC:CSU)

Traces the development and interrelationships of the major world civilizations and their cultural traditions from the era of European expansion in the sixteenth century to the present.

HUMANITIES

HUMANITIES 6
GREAT PEOPLE, GREAT AGES
3 UNITS - (RPT 1) (UC:CSU)

Lecture 3 hours.

Advisory: English 28 and 67.

Introduction to ideas and methods in the Humanities. Exploration of the way in which individuals and groups create meaning in their lives and in the world around them.

HUMANITIES 8
Great Women, Great Eras
3 UNITS - (RPT 1) (UC:CSU)

Lecture 3 hours.

Advisory: English 28 and 67.

Students are introduced to the ideas and methods in gender studies. A wide range of conceptions of how gender identities are defined across cultures and historical eras explored. Various course topics covered include: how women have resisted oppression, how women have found sources of power in family, friends, work and education, how sexuality is constructed across time and place, and how gender relations continue to evolve.

HUMANITIES 20
Japanese Civilization
3 UNITS - (UC:CSU)

Lecture 3 hours.

Advisory: English 28 and 67.

A survey of Japanese civilization from ancient times to the present; the historical and cultural backgrounds; significant aspects of Japanese culture; religion, philosophy, socio-political institutions and art forms.

HUMANITIES 30
The Beginnings of Civilization
3 UNITS - (UC:CSU)

Lecture 3 hours.

Advisory: English 28 and 67.

Introduction to Ancient Cultures and World Religions. Examination of the foundational texts, art and ideas of ancient India, China, the Middle East, Egypt and Greece.

HUMANITIES 31
People in Contemporary Society
3 UNITS - (UC:CSU)

Lecture 3 hours.

Advisory: English 28 and 67.

Examinations of the cultural encounters between European culture and the cultures of the Americas, Asia and Africa beginning from the Renaissance to present day.

HUMANITIES 41
(SAME AS CHINESE 10)
Chinese Civilization
3 UNITS - (UC:CSU)

Lecture 3 hours

Advisory: English 28 and 67.

This course offers students lectures and discussions in English on history, culture, geography, government and institutions of China; the life style and customs of the people; the language, literature, arts and sciences; the contributions to civilization.

HUMANITIES 42
(SAME AS FRENCH 10)
FRENCH CIVILIZATION
3 UNITS - (UC:CSU)

Lecture 3 hours.

Prerequisite: English 28 and 67.

An overview of the French culture from before the Romans to today. The course includes an understanding of the different dynasties ruling France through the ages. It also covers the various wars and revolutions and their affect on the arts and literature movement. It underlies the role of France in Europe and the world.

HUMANITIES 44
(SAME AS ITALIAN 10)
Italian Civilization
3 UNITS - (UC:CSU)

Lecture 3 hours.

Advisory: English 28 and 67.

Students study the cultural development of Italy. Her contributions in the field of art, architecture, literature, music and the sciences are studied in their relation to the history and institutions of her people. Lectures and discussions are in English. Designed as a humanities course, for all college students, especially for those interested in arts, music and philosophy. Recommended for Italian majors.

**HUMANITIES 45
(SAME AS KOREAN 10)
Korean Civilization
3 UNITS - (UC:CSU)**

Lecture 3 hours.

Advisory: English 28 and 67.

This course offers the students lectures and discussions in English on geography, history, government and institutions of Korea; the life and customs of the people; the literature, arts, and sciences; the contribution to civilization.

**HUMANITIES 47
(SAME AS SPANISH 9)
Hispanic Civilization
3 UNITS - (UC:CSU)**

Lecture 3 hours.

Advisory: English 28 and 67.

Geography, history, government and institutions of Spain; the life and customs of the people; the literature, music and art; and the contributions to civilization. Conducted in English. Same as Spanish 9.

**HUMANITIES 48
(SAME AS SPANISH 10)
Latin American Civilization
3 UNITS - (UC:CSU)**

Lecture 3 hours.

An exploration of the histories, cultures and arts of Latin America. The focus of the course is to study the differences and similarities between the countries that comprise Latin America, noting the unifying forces as well as those that divide. The course also explores the relationship between Latin America and the United States throughout their histories.

**HUMANITIES 61
People and Their World: The Creative Processes
3 UNITS - (UC:CSU)**

Lecture 3 hours.

Advisory: English 28 and 67.

An exploration of contemporary arts, literature, and popular culture. Sections use a range of analytic frameworks, including how the creative process is generated through myth and dreams as well as how race, class, and gender are portrayed in popular culture.

**HUMANITIES 63
Armenian Civilization
3 UNITS - (UC:CSU)**

Lecture 3 hours.

Advisory: English 28 and 67.

A survey of Armenian civilization its development from ancient times to the present. Lectures and discussions on geography, history, and social structures of Armenia; religion, literature, and sciences; art, music and customs, and the contribution to the world.

INTERNATIONAL BUSINESS

**INTERNATIONAL BUSINESS 1
International Trade
3 UNITS - (CSU)**

Lecture 3 hours.

Prerequisite: Business 1 with a satisfactory grade or better.

A study of the principles of international trade, including the

basics of operating an import and/or export business. Topics covered include: marketing, terminology, documentation, financial procedures, credits, collections, and communication.

**INTERNATIONAL BUSINESS 3
Exporting Procedures
3 UNITS - (A)**

Lecture 3 hours.

Prerequisite: International Business 1 with a satisfactory grade or better.

Identifies, defines, and explains that which is required by the United States regulatory agencies to export from the United States. Emphasis will be placed on how to determine if a commodity is acceptable for export and how to prepare the proper documentation required by the country of destination.

**INTERNATIONAL BUSINESS 4
Importing Procedures I
3 UNITS - (A)**

Lecture 3 hours.

Prerequisite: International Business 1.

The student learns how to identify, define, and explain the United States regulatory agencies requirements to import to the United States. Emphasis will be placed on how to determine what duties commodities might be subject to and how to prepare and present to the Bureau of Customs the shipment and its document.

**INTERNATIONAL BUSINESS 5
Payment Instruments and Procedures I
3 UNITS - (A)**

Lecture 3 hours.

Prerequisite: Business 1 and/or International Business 1 with satisfactory grades or better.

The student learns how to arrange and receive payment for merchandise shipped from one country to another. Topics covered include how to prepare and fill out documents. Also included is information regarding credit and political risk insurance.

**INTERNATIONAL BUSINESS 6
International Marketing I
3 UNITS - (A)**

Lecture 3 hours.

Open to all students.

Emphasizes how to get foreign customers for American made products, how to identify prospective customers, how to make contact and how to sell the product. Variables include: culture, trade customs, politics, climate, wealth, business and government structures and international law

ITALIAN

One year of high school study in Italian corresponds to one college semester or one semester of college Italian equals one full year of high school study.

**ITALIAN 1
Elementary Italian I
5 UNITS - (UC:CSU)**

Lecture 5 hours. Laboratory 1 hour.

Corresponds to the first year of high school Italian.

Advisory: English 28 and 67.

Pronunciation and grammar, practical vocabulary, useful phrases: basic facts on the geography, customs and culture of the Italian-speaking world.

ITALIAN 2
Elementary Italian II
5 UNITS - (UC:CSU)

Lecture 5 hours. Laboratory 1 hour.

Prerequisite: Italian 1 with a satisfactory grade or equivalent.

Completes elementary Italian grammar, with emphasis on written and spoken language.

ITALIAN 8
Conversational Italian
2 UNITS - (RPT 3) (UC:CSU)

Lecture 2 hours.

Prerequisite: Italian 2 with a satisfactory grade or equivalent.

Provides opportunities for conversation on current events, cultural materials and everyday topics. Emphasis is placed on idiomatic expressions. Training in pronunciation, enunciation, and vocabulary building.

UC maximum credit: 4 units.

ITALIAN 10
Italian Civilization
3 UNITS - (UC:CSU)

Lecture 3 hours.

Advisory: English 28 and 67.

Study of Civilization of Italy from the origins to the present times. Conducted in English.

ITALIAN 21 ARCHIVED
 Fundamentals of Italian I
 3 UNITS - (UC:CSU)

ITALIAN 22 ARCHIVED
 Fundamental of Italian II
 3 UNITS - (UC:CSU)

JAPANESE 3
Intermediate Japanese I
5 UNITS - (UC: CSU)

Lecture 5 hours. Laboratory 1 hour.

Prerequisite: Japanese 2 with a satisfactory grade or equivalent.

Continues the study of grammar and vocabulary building for conversational fluency and written composition. Begins the study of short narrative writings.

JAPANESE 4
Intermediate Japanese II
5 UNITS - (UC: CSU)

Lecture 5 hours. Laboratory 1 hour.

Prerequisite: Japanese 3 with a satisfactory grade or equivalent.

Completes the study of fundamental grammar and provides additional training in grammar, written composition, and the use of idioms. Greater emphasis is placed on the knowledge and use of Kanji. Continues the reading of short narrative stories.

JAPANESE 8
Conversational Japanese
2 UNITS - (RPT 3) (UC: CSU)

Lecture 2 hours.

Prerequisite: Japanese 2 with a satisfactory grade or equivalent.

Opportunities for practical conversation on everyday topics, current events, and cultural material.

UC Maximum credit: 2 times (4 units).

JAPANESE 21 ARCHIVED
 Fundamentals of Japanese I
 3 UNITS - (UC: CSU)

JAPANESE 22 ARCHIVED
 Fundamentals of Japanese II
 3 UNITS - (UC:CSU)

JAPANESE

One year of high school study in Japanese corresponds to one college semester or one semester of college Japanese equals one full year of high school study.

Required courses: Japanese 1, 2, 34; Humanities 20.

JAPANESE 1
Elementary Japanese I
5 UNITS - (UC: CSU)

Lecture 5 hours. Laboratory 1 hour.

Advisory: English 28 and 67.

Corresponds to the first year of high school Japanese.

Fundamentals of pronunciation and grammar, basic vocabulary, useful phrases; reading and writing with Romanized alphabet and Japanese scripts, basic facts on the geography, customs and culture of Japan.

JAPANESE 2
Elementary Japanese II
5 UNITS - (UC: CSU)

Lecture 5 hours. Laboratory 1 hour.

Prerequisite: Japanese 1 with a satisfactory grade or equivalent. Completes elementary Japanese I.

Continues to teach fundamentals of pronunciation and grammar. 100 additional Chinese characters will be introduced. Continues to introduce Japanese geography, customs and culture of Japan.

JOURNALISM

JOURNALISM 101
Collecting and Writing News
3 UNITS - (CSU)

Lecture 3 hours

Advisory: English 28 or equivalent.

This introductory course stresses instruction and practice in news gathering and news writing. Curriculum connects theory with meaningful activity in the basic principles of news writing, including a section on broadcast writing. The course includes an examination of freedom of the press along with a critical analysis of its responsibilities. Students receive an overview of press ethics and resolving ethical dilemmas.

JOURNALISM 105
Mass Communications
3 UNITS - (UC:CSU)

Lecture 3 hours

Advisory: English 28 and 67 or equivalent.

Course provides an examination of America's mass communications systems and how they affect human behavior in relation to social, political and economic institutions. Examines the structure and functioning in print and electronic communications including: film, print, television, radio, the recording industry, public relations and the Internet. Considers factors that influence creation and distribution of media messages, and the impact of those messages on society.

JOURNALISM 217
Publication Laboratory
2 UNITS - (RPT 3) (CSU)

Laboratory: 6 hours to be arranged.

Advisory: English 28 and 67 /31 or equivalent; Journalism 218.
 Students learn newspaper production techniques through the publication of the campus newspaper. Desktop publishing techniques include publication, newspaper design, layout, graphic techniques and materials. (Los Angeles Collegian newspaper staff class).

JOURNALISM 218
Practical Editing
3 UNITS - (RPT 3) (CSU)

Lecture 1 hour Laboratory 6 hours to be arranged

Prerequisite: Journalism 101 with a satisfactory grade or equivalent.

Advisory: English 28 and 67 /31 or equivalent; Journalism 217.
 Students learn newspaper writing and editing through the publication of the campus newspaper, the Collegian, which includes regular evaluation of stories published in the Collegian. Editions are evaluated in regularly scheduled class meetings.

JOURNALISM 219
Techniques for Staff Editors
1 UNIT - (RPT 3) (CSU)

Laboratory 3 hours to be arranged

Prerequisite: Journalism 101

Advisory: English 28 and 67 /31 or equivalent; Journalism 218.

A course in editorial writing. This course offers instruction for campus newspaper editors in editorial writing, column writing (viewpoints) and analysis of editorial problems. Emphasis is placed on formulating editorial policy.

JOURNALISM 185 DIRECTED STUDY
1 UNIT (CSU)

JOURNALISM 285 DIRECTED STUDY 2 UNITS (CSU)

Advisory: English 28 and 67 /31 or equivalent.

Conference: 1 hour per unit.

Students are urged to get the instructor's permission prior to enrolling in any of the directed study classes. Allows students to pursue Directed Study on a contract basis under the direction of a supervising instructor. Refer to the "Directed Study" section of this catalog for additional information.

Credit Limit: A maximum of 3 units in Directed Study may be taken for credit.

KOREAN

One year of high school study in Korean corresponds to one college semester or one semester of college Korean equals one full year of high school study.

KOREAN 1
Elementary Korean I
5 UNITS - (UC:CSU)

Lecture 5 hours. Laboratory 1 hour.

Advisory: English 28 and 67.

Fundamentals of pronunciation and grammar, basic vocabulary, useful phrases; develops the ability to understand, read, write and speak simple Korean. The course includes basic facts on the geography, customs and cultures of Korea.

KOREAN 2
Elementary Korean II
5 UNITS - (UC:CSU)

Lecture 5 hours. Laboratory 1 hour.

Advisory: Korean 1 with a satisfactory grade or equivalent and English 28 and 67.

Completes the elementary Korean grammar; includes the reading of elementary texts, emphasizes written composition and the spoken language.

KOREAN 3
Intermediate Korean I
5 UNITS - (UC:CSU)

Lecture 5 hours.

Advisory: Korean 2 with a satisfactory grade.

Corresponds to the second year of college level Korean. A review of grammar and idiomatic expression. Intensive and extensive reading and discussion of Korean tradition and contemporary culture and social issues.

KOREAN 4
Intermediate Korean II
3 UNITS - (UC:CSU)

Lecture 5 hours.

Prerequisite: Korean 3 with a satisfactory grade or equivalent.

Corresponds to the second year of college level Korean. Completes Intermediate Korean I emphasizing reading of intermediate texts and the spoken language.

KOREAN 8
Conversational Korean
2 UNITS - (UC:CSU)

Lecture 2 hours.

Prerequisite: Korean 2 with a satisfactory grade or equivalent.

Students will practice conversation on everyday topics, current events, and cultural material.

UC maximum credit 4 units.

KOREAN 10
(SAME AS HUMANITIES 45)
Korean Civilization
3 UNITS - (UC:CSU)

Advisory: English 28 and 67 or equivalent.

Students are introduced to the geography, history, government and institutions of Korea; the life and customs of the Korean people; Korean literature, arts, and sciences; and Korea's contribution to world civilization. Same as Humanities 45.

KOREAN 21 ARCHIVED
Fundamentals of Korean I
3 UNITS - (UC:CSU)

KOREAN 22 ARCHIVED
Fundamentals of Korean II
3 UNITS - (UC:CSU)

LINGUISTICS

LINGUISTICS 1
Introduction to Language and Linguistics
3 UNITS - (UC:CSU)

Lecture 3 hours.

Prerequisite: English 28 and 67 or equivalent.

Introduction to the scientific study of language to gain an understanding of language structures, functions, linguistic universals, and the relationship between language and cognition.

LINGUISTICS 2
Introduction to Sociolinguistics
3 UNITS - (UC:CSU)

Lecture 3 hours.

Prerequisite: English 28 and 67 or equivalent.

Advisory: Linguistics 1

Students will study the processes of linguistic variation and its relationship to geography and socio-cultural identity in both monolingual and multilingual settings. Students will gain an understanding of language as a communicative, semiotic, and cognitive tool in society.

LINGUISTICS 3 ARCHIVED

Introduction to Psycholinguistics

3 UNITS - (CSU)

LAW

LAW 1
Business Law I
3 UNITS - (UC:CSU)

Lecture 3 hours.

Students examine the U.S. legal system, focusing on the legal aspects of business; court procedures relating to business law; torts and criminal laws as related to various business practices; elements of a valid contract; breach of contracts and its remedies; sales and lease contracts.

LAW 2
Business Law II
3 UNITS - (UC:CSU)

Lecture 3 hours.

This course covers formation, operation, and dissolution of various types of business organizations. Subjects covered include: sole proprietorships, corporations, partnerships, corporations, partnerships, the law of agency and employment agreements.

LAW 3
Civil Rights and the Law
3 UNITS - (UC:CSU)

Lecture 3 hours.

The student examines the law and related problems concerning civil rights, due process, freedom of expression, freedom of religion, racial equality, and democratic processes. The emphasis is on recent court decisions and international trends.

LAW 4
Directed Field Work in Legal Assisting
3 UNITS - (A)

Lecture 1 hour. Laboratory 6 hours.

Prerequisite: Law 10 with a satisfactory grade or equivalent.

Students gain practical experience by working in a law office or other legal environment. Students are supervised by an attorney, paralegal supervisor, or other legal personnel. These unpaid internship positions are available in a variety of legal fields and legal settings. Through weekly seminars, students also gain and share information on preparing for permanent employment. Students must complete 108 hours in their internship assignments.

LAW 5 ARCHIVED

International Law of Commerce

3 UNITS - (A)

LAW 10
Introduction to Legal Assistant I
3 UNITS - (CSU)

Advisory: English 101 or equivalent.

This course has been designed to introduce the student to the paralegal profession. This course will explain the paralegal's tasks and role in the legal system. Will further explain the ethical duties and responsibilities of the paralegal.

LAW 11
Introduction to Legal Assistant II
3 UNITS - (CSU)

Lecture 3 hours.

Prerequisite: Completion of Law 10 with satisfactory grades or equivalent.

Students study a detailed examination of civil cases, the methods used in trial preparations and are introduced to legal drafting and writing.

LAW 12
Tort Law and Claims Investigation
3 UNITS - (A)

Lecture 3 hours.

Prerequisite: Law 10 with a satisfactory grade or equivalent.

This course will provide an introduction to the broad area of civil wrongs and their appropriate remedies as well as Tort Law principles in the traditional areas of intentional torts, negligence, strict liability, nuisance and the commonly employed defenses.

LAW 13
Wills, Trusts, and Probate Administration
3 UNITS - (A)

Lecture 3 hours.

This course will provide a study of the fundamental principles of the law of wills and trusts, including simple will and trust forms and formation; an examination of the organization and jurisdiction of the California Probate Court, with an overview of the administration of estates in probate.

LAW 14 ARCHIVED

Law Office Management

3 UNITS - (A)

LAW 16 ARCHIVED

Civil and Criminal Evidence

3 UNITS - (A)

LAW 17
Legal Writing
3 UNITS - (A)

Lecture 3 hours.

Prerequisite: Law 10 and English 101 with satisfactory grades or equivalent.

Students study advanced legal drafting and writing, including special research projects.

LAW 18
Marriage and Family Law
3 UNITS - (A)

Lecture 3 hours.

Prerequisite: Law 10 with satisfactory grades or equivalent.

This course presents fundamental common law and statutory concepts of family law with emphasis on California's Community Property Laws.

LAW 19
Real Property
3 UNITS - (A)

Lecture 3 hours.

Prerequisite: Law 10 with satisfactory grades or equivalent.

This course is an introduction to Real Property Law Practice. Topics include property rights, types of land ownership, agreement for sale, financing, conveyance, settlement procedures, recording and post-closing matters in residential and commercial real estate, and real estate leasing agreements. Additionally, ethical issues will be discussed.

LAW 33
Law and the Media
3 UNITS - (A)

Lecture 3 hours.

The student examines the federal, state, and local laws that most directly affect mass communication in the United States, focusing on: a basic understanding of the American legal system, its institutions, and some of its terminology; a broad understanding of First Amendment principles as they relate to mass communication; and a working knowledge of the laws that directly restrict or enhance information gathering and message dissemination in the mass media, and an understanding of the rationales behind those laws.

LAW 35
Immigration Law for Paralegals
3 UNITS - (A)

Lecture 3 hours.

Advisory: Law 10 and English 101 with satisfactory grades or equivalent.

Students learn the fundamental concepts of immigration law including grounds of exclusion, defenses to deportation, petitions and visa applications. Research and writing will be emphasized in the areas of amnesty, naturalization, citizenship, international law, criminal aspects of immigration, and various types of immigration applications.

LAW 37
Bankruptcy Law
3 UNITS - (A)

Lecture 3 hours.

Prerequisite: Law 10 with satisfactory grades or equivalent.

The main focus of this course will be on bankruptcy law and procedure. It will cover commencement of a case, preparing of schedules, operating and liquidating procedures, adversary matters and litigation in bankruptcy court, debtors' and creditors' rights and obligations, technical terminology, and practical hints for paralegals. Forms utilized in bankruptcy court will be stressed as well as proceedings under Chapter 7, Chapter 13, and to a lesser extent, Chapter 11. Also proceedings under Chapters 9 and 12 will be reviewed. Additionally, the rights of creditors will be explored. This includes secured transactions, consensual and non-consensual liens, UCC transactions, and the unique position of real estate.

LAW 38
Criminal Law
3 UNITS - (A)

Lecture 3 hours.

This course will provide students with an overview of the substantive and procedural rights of the accused. The student will study the nature, purpose, and principles of criminal law by following the process of the criminal justice system from arrest through appeal. Further, by developing knowledge of the elements of specific crimes, students will be able to assist

an attorney in preparing various legal documents in a criminal case. Special topics of interest such as plea-bargaining, youthful offender adjudication, extradition and wiretapping will be studied in detail.

LAW 43 ARCHIVED
 Elder Law
 3 UNITS - (A)

LAW 51
Legal Research for Paralegals
3 UNITS - (A)

Lecture 3 hours.

Prerequisite: Law 10 with satisfactory grades or equivalent.

Students will learn to use traditional and electronically accessed legal research. Students will perform traditional law library legal research and computer-assisted research. Students are taught to locate and use both primary, secondary and CALR legal research sources to solve legal problems, including federal and state cases, digests, statutes, regulations, treatises, encyclopedias, law reviews, citators and practice works.

LEARNING SKILLS

Registration takes place in the Learning Skills Center during the first fourteen weeks of the semester. Students will be placed at the appropriate language arts and/or mathematics level based on a diagnostic assessment in the following course offerings.

All Learning Skills courses are offered on a Credit/No Credit basis.

LEARNING SKILLS 1
Reading Comprehension
3 UNITS - (RPT 3) NDC

Laboratory 9 hours.

Individualized reading instruction for English as a Native Language (ENL) and English as a Second Language (ESL) students from beginning to advanced college level. Students will progress from reading sentences and paragraphs to short selections and excerpts from novels. Strategies are employed to help students with comprehension skills and vocabulary development. Depending upon the diagnostic assessment, students will be placed in an appropriate reading program. Students may enroll through the twelfth week of the semester. This course is open to all students. Grades are on a credit/no-credit basis.

LEARNING SKILLS 2
English Fundamentals
3 UNITS - (RPT 3)

Laboratory 9 hours.

This course is a review of beginning to advanced grammar. It is designed to cover the basic structure of the sentence, parts of speech, phrases, clauses, and agreement; using verbs, pronouns, and modifiers correctly; punctuation, clear reference, a glossary of usage, and capital letters. Depending upon the diagnostic assessment, students will be placed in an appropriate grammar program. Students may enroll through the twelfth week of the semester. This course is open to all students. Grades are on a credit/no-credit basis.

**LEARNING SKILLS 3
VOCABULARY DEVELOPMENT
5 UNITS - NDC**

Laboratory 15 hours.

Learning Skills 3A, 3B, and 3C are small group conversation classes designed to provide ESL students with class activities that will expand their comprehension and use of spoken English. Through the use of role-playing, practice dialogues, and impromptu speaking exercises, students are given the opportunity to improve their oral communication skills in a small group setting. Learning Skills 3D is an individualized, self-paced vocabulary program designed on various levels of difficulty. This course focuses on continued vocabulary growth and development, as well as provides students with helpful strategies for understanding complex vocabulary words. Learning Skills 3E-Occupational Vocabulary-is a specially designed course for students enrolled in the Child Development or Nutrition curricula. A placement test will be given to all students. Students may enroll through the fourteenth week of the semester.

**LEARNING SKILLS 4
The Mechanics of Spelling
1 UNIT - (RPT 3) NDC**

Laboratory 3 hours.

LS4 is an intensive spelling course designed for non-spellers. Emphasis is placed upon the use of a phonics, focusing on additive doubling, ie or ei, finding silent e, pronunciation aids, tricky endings, words often confused, plurals, capitals, apostrophes, and basic principles. Depending upon the diagnostic assessment, students will be placed in an appropriate program. Students may enroll through the twelfth week of the semester. This course is open to all students. Grades are on a credit/no-credit basis.

LEARNING SKILLS 6 ARCHIVED
Academic Study Skills
3 UNITS - NDC

**LEARNING SKILLS 7
Basic Composition
3 UNITS - (RPT 3)**

Laboratory 9 hours.

This course offers beginning to advanced writing instruction. Learning Skills 7 focuses upon basic sentence structures, paragraph development and essay organization. Depending upon the diagnostic assessment, students will be placed in an appropriate writing program. Students may enroll through the twelfth week of the semester. This course is open to all students. Grades are on a credit/no-credit basis.

**LEARNING SKILLS 8
Résumé Preparation and Job Search Skills
1 UNITS - (RPT 3) NDC**

Laboratory 3 hours.

This course teaches how to write a resume and cover letter. In addition, job search techniques and job interview skills are explored. Depending upon the diagnostic assessment, students will be placed in an appropriate program. Students may enroll through the twelfth week of the semester. This course is open to all students. Grades are on a credit/no-credit basis.

**LEARNING SKILLS 9
The Metric System
1 UNIT - NDC**

Laboratory 3 hours.

This course will introduce students to the concepts of the metric system such as length, perimeter, and area. Depending

upon the diagnostic assessment, students will be placed in an appropriate metric system program. Students may enroll through the twelfth week of semester. This course is open to all students. Grades are on a credit/no-credit basis.

**LEARNING SKILLS 10
Mathematics Fundamentals
3 UNITS - (RPT 3) NDC**

Laboratory 9 hours.

Individualized review of basic mathematics skills involving whole number properties, order of operations, exponents, prime numbers, fractions, decimals, percents, ratio and proportion, simple geometry, statistical graph analysis, and signed numbers. Depending upon the diagnostic assessment, students will be placed in an appropriate program. Students may enroll through the twelfth week of the semester. This course is open to all students. Grades are on a credit/no-credit basis.

**LEARNING SKILLS 11
Elementary Algebra
5 UNITS - (RPT 3) NDC**

Laboratory 15 hours.

Individualized review of basic algebra skills including the language of algebra: equations and inequalities, polynomials, factoring; rational expressions; graphing and inequalities; linear equations; exponents and radicals; quadratic equations. Depending upon the diagnostic assessment, students will be placed in an appropriate program. Students may enroll through the twelfth week of the semester. This course is open to all students. Grades are on a credit/no-credit basis.

**LEARNING SKILLS 15
Overcoming Math Anxiety
3 UNITS - (RPT 3) NDC**

Laboratory 9 hours.

This course is designed to reduce math anxiety and build self-confidence so that math concepts will be comprehensible. This course is open to all students and offered in a small group setting. Depending upon the diagnostic assessment, students will be placed in an appropriate program: LS15A-basic Mathematics, LS 15B-Elementary Algebra, and LS 15C-Intermediate Algebra. Students may enroll through the twelfth week of the semester. This course is open to all students. Grades are on a credit/no-credit basis.

**LEARNING SKILLS 17
Individualized Intermediate
3 UNITS - (RPT 3) NDC**

Laboratory 15 hours.

The student receives individualized instruction in intermediate algebra with topics including order of operations, absolute value, linear equations in one, two, and three variables, quadratic equations and inequalities, graphing equations and inequalities, polynomials, rational and radical expressions including complex numbers, conic sections, exponential and logarithmic functions, sequences, series, and binomial expansion. Depending upon the diagnostic assessment, students are placed in an appropriate intermediate algebra program. Students may enroll through the twelfth week of the semester. This course is open to all students. Grades are awarded on a credit/no-credit basis. (RPT 3)

LEARNING SKILLS 20**Effective Note Taking****1 UNIT - NDC***Laboratory 3 hours.*

LS 20 teaches the elements of effective note taking skills. Depending upon the diagnostic assessment, students will be placed in an appropriate note taking program. Students may enroll through the twelfth week of the semester. This course is open to all students. Grades are on a credit/no-credit basis.

LEARNING SKILLS 24**Theory & Practice of Tutoring****3 UNITS - NDC***Laboratory 9 hours.*

This course is designed to provide theory and practice in tutoring sessions. Also, tutor training will be provided in each tutors discipline. Students may enroll through the twelfth week of the semester. This course is open to all students. Grades are on a credit/no-credit basis.

LEARNING SKILLS 26 ARCHIVED

Basic Skills

0 UNITS - NDC

LEARNING SKILLS 27 ARCHIVED

Beginning Vocational English as a Second Language (VESL):

The World of Work

0 UNITS - NDC

LEARNING SKILLS 28 ARCHIVED

Career ways Vocational English as a
Second Language (VESL)

0 UNITS - NDC

LEARNING SKILLS 40**Introduction to Learning****Disabilities****1 UNIT - NDC***Laboratory 3 hours.*

This course will explore the nature of learning disabilities, and the laws, accommodations, and services available for academic improvement. Through assessment, students will discover personal learning strengths and weakness to develop a plan for academic success. Eligibility for support services will be determined.

**LEARNING SKILLS 41
STUDY STRATEGIES FOR THE
LEARNING DISABLED****3 UNITS - (RPT 2) NDC***Lecture 2 hours. Laboratory 2 hours.*

This study skills class is specifically designed for students with learning disabilities who need multi-sensory techniques and strategies for coping with the demands of the college's academic curriculum. Enrollment is intended for students with current functional limitations that impede or prevent the student from benefiting from their academic classes without this foundation and support.

LEARNING SKILLS 43**Adaptive Word Processing Operations****1 UNIT - (RPT 3) NDC***Laboratory 3 hours.**Offered on a Credit/No-Credit basis only.*

This course is specifically designed for students with verified disabilities who require training with adaptive computer modifications and/or assistive technology using keyboarding, word processing, database management and other appropriate applications. Enrolling is intended for students with current functional limitations that require individually-paced training.

LEARNING SKILLS 49**Introduction to Computer Assisted Instruction
Application****0.5 UNITS - (RPT 3)***Laboratory 1 hour.*

Introduction to Computer Assisted Instruction Application is designed to introduce all students to the computer as a tool for learning by using hands-on computer interactive programs. Depending upon the diagnostic assessment, students will be placed in an appropriate program. Students may enroll through the twelfth week of the semester. This course is open to all students. Grades are on a credit/no-credit basis.

LEARNING SKILLS 50**Introduction to CAI****Applications Language Arts****0.5 UNITS - (RPT 3)***Laboratory 1 hour.*

Introduction to Computer Assisted Instruction in the Language Arts is designed to introduce students to CAI Programs in the Language Arts by using hands-on interactive instructional applications programs. Depending upon the diagnostic assessment, students may enroll through the twelfth week of the semester. This course is open to all students. Grades are on a credit/ no-credit basis.

LEARNING SKILLS 52**Test Preparation for the General Education
Development (GED) Literature and Arts****1 UNIT - (RPT 3) NDC***Advisory: English 20 or LS 1A, 1B, & 1C - Reading.**Lecture 1 hour. Laboratory 4 hours.*

This course is designed to prepare students to pass the General Educational Development (GED): Literature and the Arts test. It will include critical thinking skills – reading comprehension skills, interpret graphs, analysis in literature and the arts, tone and style/prose fiction, interpret poetry, interpret drama, interpret plays, interpret non-fiction and commentaries. Depending upon the diagnostic assessment, students will be placed in appropriate program. Students may enroll through the twelfth week of semester. This course is open to all students. Grades are on a credit/no-credit basis.

LEARNING SKILLS 53**Test Preparation for the General Education
Development (GED): Writing Skills****1 UNIT - (RPT 3) NDC***Advisory: English 20, LS 1A, 1B, 1C-Basic Composition or LS 2A, 2B, 2C, English Fundamental.**Lecture 1 hour. Laboratory 4 hours.*

This course is designed to prepare students to pass the General Education Development Test (GED): Writing Skills Test. It will include basics gram- mar and usage skills, sentence structure, capitalization, punctuation, spelling, and the essay. Depending upon the diagnostic assessment, students will be placed in an appropriate program. Students may enroll through the twelfth week of the semester. This course is open to all students. Grades are on a credit/no-credit basis.

LEARNING SKILLS 54
Test Preparation for the General Education
Development (GED): Science Test
1 UNIT - (RPT 3) NDC

Advisory: English 20 or Learning Skills 1A, 1B, 1C - Reading.
Lecture 1 hour. Laboratory 4 hours.

This course is designed to prepare students to pass the General Education Development (GED): Science Test. It will include biology, earth science, astronomy, geology, meteorology, chemistry, and physics. Depending upon the diagnostic assessment, students will be placed in an appropriate program. Students may enroll through the twelfth week of the semester. This course is open to all students. Grades are on a credit/no-credit basis.

LEARNING SKILLS 55
Test Preparation for the General Education
Development (GED): Mathematics
1 UNIT - (RPT 3) NDC

Advisory: Math 105 or Learning Skills 10A, 10B, & 10C.
Lecture 1 hour. Laboratory 4 hours.

This course is designed to prepare students to pass the GED: Math Test. Concepts covered include basic arithmetic, metrics, algebra, geometry, statistics, and probability.

LEARNING SKILLS 56
Test Preparation for the General Education
Development (GED): Social Studies
1 UNIT - (RPT 3) NDC

Advisory: English 20 or Learning Skills 1A, 1B, & 1C - Reading.
Lecture 1 hour. Laboratory 4 hours.

This course is designed to prepare students to pass the GED: Social Studies Test. It will include thirteen English Colonies, the Revolutionary War, inflation and its effects, various branches of government, time zones, anthropology, sociology, and psychology.

LEARNING SKILLS 185
Directed Study – Learning Skills
1 UNIT – (RPT 2)

Laboratory 1 hour.

This course allows learning skills students to pursue directed studies in reading, writing, mathematics and/or study skills on a contract basis under the supervision of Learning Skills Instructor. Consultation with the instructor on a weekly basis, plus independent work is required. A maximum of 3 units in Directed Study may be taken for credit. Depending upon the diagnostic assessment, students will be placed in an appropriate program. Students may enroll through the twelfth week of the semester. Grades are on a credit/ no-credit basis.

LEARNING SKILLS 285
Directed Study – Learning Skills
2 UNITS – (RPT 2)

Laboratory 2 hours.

This course allows learning skills students to pursue directed studies in reading, writing, mathematics and/or study skills on a contract basis under the supervision of Learning Skills Instructor. Consultation with the instructor on a weekly basis, plus independent work is required. A maximum of 3 units in Directed Study may be taken for credit. Depending upon the diagnostic assessment, students will be placed in an appropriate program. Students may enroll through the twelfth week of the semester. Grades are on a credit/ no-credit basis.

LEARNING SKILLS 385
Directed Study – Learning Skills
3 UNITS

Laboratory 3 hours.

This course allows learning skills students to pursue directed studies in reading, writing, mathematics and/or study skills on a contract basis under the supervision of Learning Skills Instructor. Consultation with the instructor on a weekly basis, plus independent work is required. A maximum of 3 units in Directed Study may be taken for credit. Depending upon the diagnostic assessment, students will be placed in an appropriate program. Students may enroll through the twelfth week of the semester. Grades are on a credit/ no-credit basis.

LEARNING SKILLS 485
Internet Research
1 UNIT – (RPT 2)

Laboratory 2 hours.

The Internet Research course teaches students how to use search engines; basic and advanced searches with Boolean operators; how to locate, store, and retrieve materials in various content fields; how to critically evaluate these sources; and how to use cite electronic resources. Depending upon the diagnostic assessment, students will be placed in an appropriate program. Students may enroll through the twelfth week of the semester. Grades are on a credit/no-credit basis.

LIBERAL ARTS

(TRANSFER MAJOR-See a Counselor for Information Interdisciplinary Program)

LIBRARY SCIENCE

The Library department is designed to help students succeed in their college classes. The courses give students confidence in doing research using standard library resources as well as the Internet.

LIBRARY SCIENCE 101
Library Research Methods
1 UNIT – (UC:CSU)

Laboratory 3 hours.

Advisory: CAOT 1

The student learns basic research skills. This is a self-paced course in the use of the Library, its print and selected on-line resources and the rudiments of research.

LIBRARY SCIENCE 102
Internet Research Methods
1 UNIT – (UC:CSU)

Recommended: Knowledge of Windows; Basic keyboarding skills.

Locate and evaluate information resources on the Internet. Learn principles of information access, search strategies, evaluation criteria and processes. Issues regarding intellectual property, censorship, and online publishing will be covered

MANAGEMENT

MANAGEMENT 2 Organization and Management Theory 3 UNITS - (CSU)

Lecture 3 hours.

Advisory: Business I or equivalent.

A study of the process of management, the establishment and achievement of objectives, decision making, organization, planning, control, and managerial authority.

MANAGEMENT 6 Public Relations 3 UNITS - (RPT 1) (CSU)

Lecture 3 hours.

Advisory: Eligibility for English 28 and 67 or equivalent.

Students learn instructions on the role of public relations as integral part of an organization's overall promotion strategy.

MANAGEMENT 13 Small Business Entrepreneurship I 3 UNITS - (CSU)

Lecture 3 hours.

Designed to teach the student how to organize and operate a small business.

MANAGEMENT 31 Human Relations for Employees 3 UNITS - (CSU)

Lecture 3 hours.

Advisory: English 28 and 67 or equivalent.

Helps the student to recognize and develop those traits necessary for good relations with fellow workers, supervisors, subordinates, customers, and other business associates.

MANAGEMENT 33 Personnel Management 3 UNITS - (CSU)

Lecture 3 hours.

Advisory: English 28 and 67 or equivalent.

This course covers the essentials of human resource management. Topics include recruitment, selection, training, appraisals, compensations, benefits, labor relations and collective bargaining.

MARKETING

MARKETING 1 Principles of Selling 3 UNITS - (CSU)

Lecture 3 hours.

Advisory: English 28 and 67 or equivalent.

The student learns about selling careers, role of personality in selling, how to use product knowledge, prospecting, how to start the sale, demonstrate the product, handle sales resistance, and close the sale.

MARKETING 11 Fundamentals of Advertising 3 UNITS - (CSU)

Lecture 3 hours

Advisory: English 28 and 67 or equivalent. Open to all students.

Students have an opportunity to explore the planning process, the strategies and the techniques used by corporations and small businesses to stimulate sales.

MARKETING 13

Marketing 1 UNIT - (A)

Laboratory 3 hours.

Advisory: English 28 and 67; Marketing 11.

Students receive instructions on how to formulate and evaluate an advertising plan.

MARKETING 21 Principles of Marketing 3 UNITS - (CSU)

Lecture 3 hours.

Advisory: English 28 and 67 or equivalent.

The student explores types of markets and their characteristics, planning the products, selection of dealers and distributors, promotion of the products, international marketing.

MARKETING 24 Marketing Problems 3 UNITS

Lecture 3 hours.

Advisories: Marketing 21 or 31 or 13.

This course allows students, with the help and guidance of the instructor, to work on a problem of their own interest in the field of marketing.

MARKETING 31 Retail Merchandising 3 UNITS - (CSU)

Lecture 3 hours.

The student receives a working knowledge of the principles and procedures in retailing, including a study of store location, store layout, store organization, buying, pricing, stock planning, and retail sales promotion.

MATHEMATICS

Placement Information

High school courses are not accepted as equivalent to college courses. Every new incoming student will be required to take the math assessment unless he/she has satisfied the prerequisite by a college level course or a comparable assessment process from another college (must not be based on high school transcripts).

Those students placing above Math 125 please note: If the placement information given to you does not fit your circumstances, see Math Department for more detailed evaluation.

UC maximum limit: Refer to www.assist.org

MATHEMATICS 90 Quantitative Evaluation 0.5 UNITS

Lecture 0.5 hour.

Students learn reasoning, data analysis, and quantitative problem solving.

MATHEMATICS 100 Mathematics Workshop 1 UNIT - NDC

Laboratory 3 hours.

Co-requisite: MATH 105 or 111 or 113 or 114 or 115 or 124.

This course is designed to supplement and enhance learning experience by providing tutorial and self-help assistance, using tutorial assistance, calculators, computers, programmed texts, and other learning aids.

MATHEMATICS 105
Arithmetic for College Students
3 UNITS - NDC

Lecture 3 hours.

Open to all students.

This course reviews the fundamentals of arithmetic that are essential to success in many college courses.

MATHEMATICS 112
Pre-Algebra
3 UNITS - NDC

Lecture 3 hours.

Prerequisite: Mathematics 105 with a satisfactory grade or equivalent.

This course bridges the gap between Arithmetic and Algebra. In addition to a brief review of Arithmetic, topics include signed numbers, laws of exponents, polynomial operations, mathematical sentences, and an introduction to graphs in Cartesian coordinates.

MATHEMATICS 113
Elementary Algebra A
3 UNITS - (A)

Lecture 3 hours.

Prerequisite: Mathematics 112 with a satisfactory grade or equivalent.

Mathematics 113 and 114 together are equivalent to Mathematics 115 (see course description for Mathematics 115). Credit for Elementary Algebra can only be earned once, either through Mathematics 115, or through the Mathematics 113 and 114 sequence. Simultaneous enrollment in Math 113 and 114 is not permitted.

MATHEMATICS 114
Elementary Algebra B
3 UNITS - (A)

Lecture 3 hours

Prerequisite: Mathematics 113 with a satisfactory grade or equivalent.

Mathematics 113 and 114 together are equivalent to Mathematics 115 (see course description for Mathematics 115). Credit for Elementary Algebra can only be earned once, either through Mathematics 115, or through the Mathematics 113 and 114 sequence. Simultaneous enrollment in Math 113 and 114 is not permitted.

MATHEMATICS 115
Elementary Algebra
5 UNITS - (A)

Lecture 5 hours.

Prerequisite: Mathematics 112 with a satisfactory grade or equivalent.

This course is for those who have had no algebra or whose preparation in algebra is deficient. Topics include variables, polynomials, equations, factoring, systems of linear equations, graphs, inequalities and quadratic equations.

MATHEMATICS 117 **ARCHIVED**
Basic Elementary Algebra I
5 UNITS

MATHEMATICS 120 ARCHIVED

Plane Geometry

5 UNITS - (A)

MATHEMATICS 121
Essentials of Geometry
3 UNITS - (A)

Lecture 3 hours.

Prerequisite: Mathematics 115 with a satisfactory grade or equivalent.

This course covers the definitions, axioms and theorems of geometry relating to angles, lines, circles and polygons. Basic constructions are introduced. The meaning and techniques of logical proofs are heavily emphasized.

MATHEMATICS 124
Intermediate Algebra
5 UNITS - (A)

Lecture 4 hours. Laboratory 2 hours.

Prerequisite: Mathematics 115 with satisfactory grade or equivalent.

The student learns the laws of exponents, equations in one variable (linear, quadratic, and some of higher degree), systems of linear and non-linear equations, graphical representations, exponential and logarithmic functions, complex numbers, and binomial theorem. Some students are unable to assimilate Intermediate Algebra in a one semester and need two. This course will provide the student with the extra needed time.

Credit for Intermediate Algebra can only be earned once, either through Mathematics 125, or through the Mathematics 124A and 124B sequence. Simultaneous enrollment in Math 124A and 124B is not permitted.

MATHEMATICS 125
Intermediate Algebra
5 UNITS - (A)

Lecture 5 hours.

Prerequisite: Mathematics 115 with a satisfactory grade or equivalent.

Note: A maximum of 8 units may be earned by any combination of Mathematics 125, 240, and 245.

Students study the laws of exponents, equations in one variable (linear, quadratic, and some of higher degree), systems of linear and non-linear equations, graphical representations, exponential and logarithmic functions, complex numbers, and binomial theorem.

MATHEMATICS 135
Using The Computer for Mathematics
1 UNIT - (CSU)

Lecture 0.5 hour. Laboratory 1 hour.

Prerequisite: Mathematics 125 with a satisfactory grade or equivalent.

Math 135 is an introduction to a computer algebra system, which is useful for problem-solving in science and mathematics. A particular system will be taught. Students will learn to simplify expressions, solve equations, and graph.

MATHEMATICS 202
Mathematics Workshop
1 UNIT - (CSU)

Laboratory 3 hours.

Co-requisite: One of the following MATH 215, 216, 225, 226, 230, 235, 236, 237, 240, 245, 260, 261, 262, 263, 270, or 275

This course is designed to supplement and enhance learning in mathematics by providing tutorial and self-help assistance, calculators, computers, programmed text, and other learning aids for baccalaureate level mathematics courses. Simultaneous enrollment in Mathematics 100 and Mathematics 202 is not permitted.

MATHEMATICS 215
Principles of Mathematics I
3 UNITS - (UC:CSU)

Lecture 3 hours.

Prerequisite: Mathematics 125 with a satisfactory grade or equivalent.

This course is the first of two in a sequence designed for prospective elementary school teachers. Topics include sets and relations, numbering systems, and elementary number theory. The main emphasis, however, will be understanding the structure of systems of whole numbers, integers, and rational numbers.

MATHEMATICS 216
Principles of Mathematics II
3 UNITS - (UC:CSU)

Lecture 3 hours.

Prerequisite: Mathematics 215 with a satisfactory grade or equivalent.

This course is the second of two in a sequence for prospective elementary school teachers. Topics include decimal and real numbers, rational numbers, abstract mathematical systems, geometry and the metric system.

MATHEMATICS 225 ARCHIVED

Introductory Statistics

3 UNITS - (UC:CSU)

MATHEMATICS 226
Elementary Statistics Problem Solving
1 UNIT - (CSU)

Lecture 1 hour.

Prerequisite: Mathematics 125 with a satisfactory grade or equivalent.

Co-requisite: Mathematics 225 or equivalent to be taken simultaneously or completed previously.

Problem solving techniques related to probability, sampling, measures of central tendency and dispersion, various distributions, hypotheses testing, correlation and regression are covered as time allows.

MATHEMATICS 227
Statistics
4 UNITS - (UC:CSU)

Lecture 4 hours.

Prerequisite: Mathematics 125 with a satisfactory grade or equivalent.

This course is an introduction to probability, descriptive and inferential statistics including measures of central tendency and dispersion, sampling, and estimation. Hypothesis testing, analysis of variance, test of independence, linear correlation and regression analysis also are covered.

MATHEMATICS 230
Mathematics for Liberal Arts Students
3 UNITS - (UC:CSU)

Lecture 3 hours.

Prerequisite: Mathematics 125 with a satisfactory grade or equivalent.

This course is intended for liberal arts majors. Topics include sets and counting, probability, linear systems, linear programming, statistics and mathematics of finance with applications for liberal arts majors, and logic.

NOTE: This course will satisfy the high school Mathematics requirement for admission to the UC.

MATHEMATICS 235 ARCHIVED

Finite Mathematics

5 UNITS - (UC:CSU)

MATHEMATICS 236
Calculus for Business and Social Sciences
5 UNITS - (UC:CSU)

Lecture 5 hours.

Prerequisite: Mathematics 125 with a satisfactory grade or equivalent.

Calculus: limits, derivatives, optimization, antiderivatives, and definite integrals and their applications in Business, Economics, and Social Sciences. (This course contains some topics of Precalculus: Analysis of polynomial, rational, exponential and logarithmic functions, including their graphs.)

MATHEMATICS 237
Advanced Calculus for Business and Social Sciences
3 UNITS - (UC:CSU)

Lecture 3 hours.

Prerequisite: Mathematics 236 with a satisfactory grade or equivalent.

Students learn advanced calculus topics with emphasis on business and social science applications. Topics include definite integrals, probability, techniques of integration, improper integrals, numerical integration, elementary differential equations, functions of several variables, partial derivatives, chain rule, total differentials, optimization of functions of several variables without and with constraints, method of Lagrange multipliers, double integrals.

NOTE: This course is not offered every semester. See Class Schedule.

MATHEMATICS 240
Trigonometry
3 UNITS - (CSU)

Lecture 3 hours.

Prerequisite: Mathematics 125 and Mathematics 121 with satisfactory grades or equivalent.

A maximum of 8 units of credit may be earned by any combination of Mathematics 125, 240 and 245.

The student applies analytical trigonometry to solve right and oblique triangles. Topics include inverse trigonometric functions and trigonometric equations.

MATHEMATICS 245
College Algebra
3 UNITS - (UC:CSU)

Lecture 3 hours.

Prerequisite: Mathematics 125 with a satisfactory grade or equivalent.

Topics include theory of equations, polynomial and rational functions and their graphs, systems of equations, matrices, determinants, permutations, combinations, probability, sequences and series, binomial theorem, mathematical induction.

MATHEMATICS 260**Precalculus****5 UNITS - (UC:CSU)**

Lecture 5 hours.

Prerequisite: Mathematics 240 with a satisfactory grade or equivalent.

This course prepares students for calculus. Properties of polynomial, rational, algebraic, trigonometric, inverse trigonometric, exponential and logarithmic identities and equations, trigonometric form of complex numbers and DeMoivre's Theorem, conic sections with translation and rotation of axes, nonlinear system of equations and inequalities, vector algebra with dot and cross products, polar coordinates and graphs of polar functions, partial fractions and mathematical induction.

MATHEMATICS 261**Calculus I****5 UNITS - (UC:CSU)**

Lecture 5 hours.

Prerequisite: Mathematics 260 with a satisfactory grade or equivalent.

Includes functions and their graphs, limits, continuity, derivatives of functions of one variable, Mean Value Theorem, integrals, the Fundamental Theorem of Calculus, differentiation and integration.

MATHEMATICS 262**Calculus II****5 UNITS - (UC:CSU)**

Lecture 5 hours.

Prerequisite: Mathematics 261 with a satisfactory grade or equivalent.

Students learn the differentiation of transcendental functions, techniques of integration, sequences, infinite series, and curves in polar coordinates.

MATHEMATICS 263**Calculus III****5 UNITS - (UC:CSU)**

Lecture 5 hours.

Prerequisite: Mathematics 262 with a satisfactory grade or equivalent.

Topics includes: vector calculus, and parametric equations, surfaces, partial differentiation, gradient, maxima and minima for functions of several variables, multiple integrals, surface integrals, line integrals, Green's Theorem, Divergence Theorem, and Stokes' Theorem.

MATHEMATICS 270**Linear Algebra****3 UNITS - (UC:CSU)**

Lecture 3 hours.

Prerequisite: Mathematics 261 with a satisfactory grade or equivalent.

Advisory: Simultaneous enrollment in Mathematics 262. Students study vector spaces, linear transformation, matrices, matrix algebra, and solutions of systems of equations.

MATHEMATICS 272**Methods of Discrete Mathematics****5 UNITS - (UC:CSU)**

Lecture 5 hours.

Prerequisite: Mathematics 262 with a satisfactory grade or equivalent.

This course stresses mathematical reasoning and the different ways problems are solved. Interwoven in this course are: mathematical reasoning (logic and mathematical proofs), algorithm (use of pseudocode), combinatorial analysis (ability to count), and discrete structures and their basic applications.

MATHEMATICS 275**Ordinary Differential Equations****3 UNITS - (UC:CSU)**

Lecture 3 hours.

Prerequisite: Mathematics 262 with a satisfactory grade or equivalent.

This course examines and applies techniques for solution of ordinary differential equations including first order equations, linear equations of higher order and linear systems of equations. Methods of solution include undetermined coefficients, differential operators, variation of parameters, series solutions, Laplace Transforms, reduction to first order system and numerical methods such as Euler's, Runge-Kutta and multi-step.

METEOROLOGY**METEOROLOGY 3****(Same as Geography 3)****Introduction To Weather And Climate****3 UNITS - (UC:CSU)**

Lecture 3 hours

Advisory: English 28 and 67 or equivalent.

Students learn about Earth-Sun relationships, atmospheric composition and structure, energy transfer, temperature, pressure and winds, humidity, clouds and precipitation, stability, storms and severe weather, forecasting, and climate in order to understand weather patterns on local, regional, and global scales. This course also includes a treatment of timely environmental topics such as global warming, ozone hole, El Nino, and air pollution. Same as Geography 3.

MICROBIOLOGY

UC Limit: Microbiology 1 and 20 combined: maximum credit allowed, one course.

MICROBIOLOGY 1**Introductory Microbiology****5 UNITS - (UC:CSU)**

Lecture 3 hours. Laboratory 6 hours.

Prerequisite: Chemistry 60, Biology 3, with a satisfactory grade of better or equivalent.

Advisory: Eligibility for English 28 and 67/31 or equivalent.

In the course are bacterial physiology, cytology, genetics, growth and reproduction, and the effects of physical and chemical agents on the bacterial cell. Applied fields covered are food, water, milk, air, soil and industrial microbiology. The immune response, diseases and bacteriologic techniques are stressed.

MICROBIOLOGY 20**General Microbiology****4 UNITS - (UC:CSU)**

Lecture 2 hours. Laboratory 6 hours.

Advisory: English 21 or equivalent.

This is a general microbiology course stressing diseases produced by micro-organisms and including an introduction to bacterial classification, cytology, physiology, growth, reproduction, sterilization, disinfect ion and the applied fields of bacteriology. Bacteriological techniques are emphasized in the laboratory.

MICROBIOLOGY 40
Microbiology Laboratory
Preparations
1 UNIT - (RPT 2) (CSU)
Laboratory 3 hours.

This course emphasizes the preparation of media and reagents normally used in a bacteriological laboratory. Use and care of laboratory equipment and supplies are included.

MUSIC

COURSE DESCRIPTIONS

AUDITIONS TO MEET THE PREREQUISITE

Students enrolling in music classes with a performance level prerequisite who have not taken the prerequisite may audition as directed by the instructor at the first meeting of the class to confirm a performance level equal to that of the prerequisite.

AUDITIONS FOR MUSIC ENSEMBLE

Students enrolling in Music Ensemble classes where the description indicates a need for an audition will audition as directed by the instructor at the first class meeting.

NOTE: Not every class is offered each semester. Refer to the current class schedule for current class offerings.

PREREQUISITES: Specified prerequisites must be completed with a satisfactory grade or equivalent.

Courses that are part of a sequenced transfer curriculum in music are repeatable up to three times. Students may repeat Music 180, 184, 250, 251, 311, 312, 313, 314, 341, 351, 361, 381, 382, 383, 384, 403, 414, 433, 453, 501, 511, 521, 531, 561, 604, 614, 624, 634, 654, 664, 705, 711, 725, 731, 751, 765, 771, 775 and 781 up to three times if they are declared music majors; have completed the admission, assessment and orientation portions of the college's Matriculation Program; have an approved Student Education Plan; and have spoken with the Music Department Chair.

MUSIC 101
Fundamentals of Music
3 UNITS - (UC:CSU)
Lecture 3 hours.

(For the non Music major.) A study of the fundamentals of music including notation, major and minor key signatures and scales, intervals, time signatures and rhythms, and triads. Some sight reading and ear training is included. Satisfies Humanities requirement.

MUSIC 111
Music Appreciation I
3 UNITS - (UC:CSU)
Lecture 3 hours.

Required of all Music majors. Open to all students.

The student learns about masterpieces of music from the Middle Ages to the present day with an emphasis on perceptive listening. Fulfills humanities requirements for graduation.

MUSIC 111H ARCHIVED
 Music Appreciation I Honors
 3 UNITS - (UC:CSU)

MUSIC 120
Music Technology Practice Lab
0.5 UNITS - (RPT3)

Laboratory 1 hour.

Co-requisite: Either Music 161, 241, 242, 243, 244, 261, 281, 282, 291, 292, 293, or 294.

This course allows students currently enrolled in any of the co-requisite music technology classes to use the lab equipment and materials to enhance applicable skills necessary for success.

MUSIC 121
Music History and Literature I
3 UNITS - (UC:CSU)

Lecture 3 hours.

Advisories: Music 111 and Music 202.

The student studies music history and literature from earliest times to 1750, including music of the ancient Greeks, early Christians, Middle Ages, Renaissance and Baroque periods, through the music of Bach and Handel.

MUSIC 122
Music History and Literature II
3 UNITS - (UC:CSU)

Lecture 3 hours.

Advisory: Music 111 and Music 202.

This course is a survey of music history and music literature from 1750 to the present time, including music of the Pre-Classic, Classic, and Romantic periods, as well as Contemporary 20th Century music.

MUSIC 130 ARCHIVED
Music for Early Childhood Education
3 UNITS - (CSU)

MUSIC 133 ARCHIVED
 Introduction to Asian Music
 3 UNITS - (UC:CSU)

MUSIC 135
African-American Music
3 UNITS - (UC:CSU)

Lecture 3 hours.

A study of African and African American music and their influences on folk, spirituals, gospels, concert music, opera, ballet, blues and jazz underscoring styles, characteristics, origin and contributions by African-American artists. (Credit allowed for only one of Music 135 and African-American Studies 60.)

MUSIC 137
Music as a Business
3 UNITS - (A)

Lecture 3 hours.

The student learns the skills and knowledge necessary for success in the many careers available in the music industry. Covers the roles of personal managers, agents and attorneys; the process of producing, publishing and copyrighting songs; and record production and marketing.

MUSIC 140
Advanced Practice Lab-Music Technology
0.5 UNITS

Laboratory 1 hour.

Prerequisite: Music 120 or equivalent.

Co-requisite: Either Music 161, 241, 242, 243, 244, 261, 281, 282, 291, 292, 293, or 294

The student uses departmental computer labs to further enhance applicable skills necessary for success in the co-requisite course. For advanced students who have completed Music 120 four times.

MUSIC 141 ARCHIVED

Jazz Appreciation

3 UNITS - (UC:CSU)

MUSIC 146 ARCHIVED

Music for Elementary School Teachers

3 UNITS - (CSU)

MUSIC 147 ARCHIVED

Multicultural Music Materials for Early Childhood Education

3 UNITS - (CSU)

MUSIC 150 ARCHIVED

Practice Lab - Early Childhood Music

0.5 UNITS - (RPT3)

MUSIC 152
Current Musical Events
1 UNIT - (RPT 3) (CSU)

Laboratory 2 hours.

Live musical performances of a wide variety of styles, including guest artists, chamber groups, students, faculty, departmental organizations, and lectures and demonstrations.

MUSIC 161
Introduction to Electronic Music
3 UNITS - (CSU)

Lecture 2 hours. Laboratory 2 hours.

The student learns electro-acoustic, MIDI and computer assisted music techniques for both the MAC and PC platforms. Emphasis is in computer-assisted sequencing, digital and MIDI recording, mixing, sound reinforcement and CD production.

MUSIC 180
Applied Music Laboratory
1.5 UNITS - (RPT 3) (A)

Laboratory 5 hours.

Co-requisite: Either Music 181, 182, 183 or 184.

The student uses departmental labs to further enhance applicable skills necessary for success in the co-requisite applied music course.

MUSIC 181
Applied Music I
1 UNITS - (UC:CSU)

Laboratory 1 hour.

Co-requisite: Music 180.

Individual instruction in voice or a musical instrument for transfer-oriented music majors as determined by the Music Department. (Confirmation of enrollment subject to audition.)

MUSIC 182
Applied Music II
1 UNITS - (UC:CSU)

Laboratory 1 hour.

Prerequisite: Music 181 with a satisfactory grade or equivalent.

Co-requisite: Music 180.

The student receives second level individual instruction and master classes in voice or a musical instrument. For transfer-oriented music majors as determined by the Music Department. (Confirmation of enrollment subject to audition.)

MUSIC 183
Applied Music III
1 UNITS - (UC:CSU)

Laboratory 1 hour.

Prerequisite: Music 182 with a satisfactory grade or equivalent.

Co-requisite: Music 180.

The student receives third level individual instruction and master classes in voice or a musical instrument. For transfer-oriented music majors as determined by the Music Department. (Confirmation of enrollment subject to audition.)

MUSIC 184
Applied Music IV
1 UNITS - (UC:CSU)

Laboratory 1 hour.

Prerequisite: Music 183 with a satisfactory grade or equivalent.

Co-requisite: Music 180.

The student receives fourth level individual instruction and master classes in voice or a musical instrument. For transfer-oriented music majors as determined by the Music Department. (Confirmation of enrollment subject to audition.)

MUSIC 185 DIRECTED STUDY - 1 UNIT (CSU) (RPT 2)

Laboratory 1 hour.

Vocal and instrumental students pursue directed study on a contract basis under the direction of a supervising instructor. A maximum of 3 units in Directed Study may be taken for credit.

MUSIC 200
Introduction to Music Theory
4 UNITS - (UC:CSU)

Lecture 5 hours.

Co-requisite: Music 300

The student learns the basic elements of music, notation, music reading, sight singing and ear training. Functions as the introductory course for the Music major. Students taking this class should also enroll in Music 300.

MUSIC 201
Harmony I
3 UNITS - (UC:CSU)

Lecture 3 hours.

Prerequisite: Music 200 with a satisfactory grade or equivalent.

Co-requisite: Music 211 and Music 301

The student studies diatonic harmony including primary and secondary triads, the dominant seventh chord and their inversions. Also includes harmonizing figured and unfigured bass, simple melodies and the writing of original phrases. Students taking this class should also enroll in Music 211 and Music 301.

MUSIC 202
Harmony II
3 UNITS - (UC:CSU)

Lecture 3 hours.

Prerequisite: Music 201 with a satisfactory grade or equivalent.

The student studies more advanced diatonic and chromatic harmony including seventh chords, modally borrowed chords, sequences, secondary dominants and secondary diminished sevenths, simple modulations and the writing of short original compositions. Students enrolling in this class should also enroll in Music 212 and Music 302.

MUSIC 203
Harmony III
3 UNITS - (UC:CSU)

Prerequisite: Music 202 with a satisfactory grade or equivalent.

The student writes and analyzes advanced chromatic harmony. Students demonstrate skill required by harmonizing figured and unfigured bass melodies and writing short original compositions.

MUSIC 211
Musicianship I
2 UNITS - (UC:CSU)

Lecture 1 hour. Laboratory 2 hours.

Prerequisite: Music 200 with a satisfactory grade or equivalent.

Co-requisite: Music 201 and Music 301.

The student reads and plays simple diatonic melodies, two part play-and-sing drills, and simple melodic, harmonic, and rhythmic dictation.

MUSIC 212
Musicianship II
2 UNITS - (UC:CSU)

Lecture 1 hour. Laboratory 2 hours.

Prerequisite: Music 211 with a satisfactory grade or equivalent.

Co-requisite: Music 202 and Music 302

The student reads and plays intermediate level tonal and modal melodies, melodic, harmonic, and rhythmic dictation. Sight singing and ear training are stressed.

MUSIC 213
MUSICIANSHIP III
2 UNITS - (UC:CSU)

Lecture 1 hour. Laboratory 2 hours.

Prerequisite: Music 212 with a satisfactory grade or equivalent.

Co-requisite: Music 203 and 303

The student reads and plays advanced chromatic melodies, harmonies, and rhythms using sight singing, ear training, and dictation.

MUSIC 220
Music Theory and Listening Lab
0.5 UNITS - (RPT 3)

Laboratory 1 hour.

Co-requisite: Music 200, 201, 202, 203, 211, 212, 213, 221, 223, 230, 231, 232, 300, 301, 302, or 303.

This course allows students currently enrolled in any of the co-requisite music theory classes to use the lab equipment and materials to enhance applicable skills necessary for success.

MUSIC 221
Counterpoint I
3 UNITS - (UC:CSU)

Lecture 3 hours.

Prerequisite: Music 202 with a satisfactory grade or equivalent.

The student studies 18th-century contrapuntal techniques in two, three and four voices, including species counterpoint, invertible counterpoint, motive development and canon and resulting in analysis and composition of two-part inventions, binary dance forms and three and four-part fugue expositions.

MUSIC 222
Counterpoint II
3 UNITS - (UC:CSU)

Lecture 3 hours.

The student continues the study of 18th-century contrapuntal techniques including analysis and composition of three and four-voice fugues, chorale preludes, and contrapuntal variations.

MUSIC 223
Twentieth Century Compositional Techniques
3 UNITS - (UC:CSU)

Lecture 3 hours.

Prerequisite: Music 202 with a satisfactory grade or equivalent.

The student learns melodic, harmonic and rhythmic techniques of the Twentieth Century, resulting in the writing of original compositions.

MUSIC 230 ARCHIVED
Jazz and Commercial Harmony
3 UNITS - (CSU)

MUSIC 231
Orchestration and Arranging I
3 UNITS - (UC:CSU)

Lecture 3 hours.

Prerequisite: Music 202 with a satisfactory grade or equivalent.

Advisory: Music 241.

The student studies instrumentation and beginning orchestration, including writing for various instrumental groups.

MUSIC 232
Orchestration and Arranging II
3 UNITS - (UC:CSU)

Lecture 3 hours.

Prerequisite: Music 231 with a satisfactory grade or equivalent.

This course offers training in advanced orchestration and arranging. Covers advanced writing for various instrumental groups of the symphony orchestra and jazz band. One Romantic era or 20th Century orchestration and one advanced jazz band arrangement will be completed.

MUSIC 240
Advanced Practice Lab-Music THEORY AND LISTENING
0.5 UNITS- (RPT 3)

Laboratory 1 hour.

Prerequisite: Music 220 or equivalent.

Co-requisite: Music 200, 201, 202, 203, 211, 212, 213, 300, 301, 302, or 303.

The student uses departmental labs to further enhance applicable skills necessary for success in the co-requisite course. For advanced students who have completed Music 220 four times.

MUSIC 241
Music Notation and Copying I
1 UNIT - (CSU)

Lecture 1 hour.

Instruction and practical experience in the techniques and materials required for music preparation to create both handwritten and computer generated scores. This course does not deal with music composition, but only with how to copy existing music in a professional manner.

MUSIC 242
Music Notation and Copying II
1 UNIT - (CSU)

Lecture 1 hour.

Prerequisite: Music 241 with a satisfactory grade or equivalent.

Continued instruction and practical experience in the techniques and materials required for music preparation to create both handwritten and computer generated scores.

MUSIC 243
Music Notation and Copying III
1 UNIT - (CSU)

Lecture 1 hour.

Prerequisite: Music 242 with a satisfactory grade or equivalent.

Continued instruction and practical experience in the techniques and materials required for music preparation to create both handwritten and computer generated scores.

MUSIC 244
Music Notation and Copying IV
1 UNIT - (CSU)

Lecture 1 hour.

Prerequisite: Music 243 with a satisfactory grade or equivalent.

Continued instruction and practical experience in the techniques and materials required for music preparation to create both handwritten and computer generated scores.

MUSIC 250
Music Performance Workshop
1 UNIT - (RPT 3) (CSU)

Laboratory 3 hours.

The student prepares, rehearses and performs selected musical works. Illustration and discussion of various concepts of musical performance are emphasized. (Confirmation of enrollment is subject to audition).

MUSIC 251
Jazz Improvisation Workshop
1 UNIT - (RPT 3) (UC:CSU)

Laboratory 3 hours.

Prerequisite: Music 202 with a satisfactory grade or equivalent.

The student improvises and performs the standard repertoire in a jazz combo setting. For intermediate to advanced jazz instrumentalists only.

(Confirmation of enrollment is subject to audition.)

MUSIC 252 ARCHIVED

Jazz Structure
 3 UNITS - (UC:CSU)

MUSIC 261
Electronic Music Workshop
3 UNITS - (RPT 2) (CSU)

Lecture 2 hours. Laboratory 2 hours.

Prerequisite: Music 161 and Music 101 with a satisfactory grade or equivalent.

The student learns advanced electro-acoustic, MIDI event and audio editing, digital audio data management and synchronization.

MUSIC 271
Songwriter's Workshop
3 UNITS - (CSU)

Lecture 3 hours.

Students learn the conventions of songwriting including lyrics, melody the relationship of lyrics and music, harmony, and song structure. Students analyze a wide variety of songs and apply the conventions of songwriting in the composition and performance of original songs.

MUSIC 281
COMMERCIAL MUSIC TECHNIQUES I
3 UNITS - (CSU)

Lecture 2 hours. Laboratory 2 hours.

Prerequisite: Music 161 and Music 201 with a satisfactory grade or equivalent.

This is the first in a sequence of courses offering opportunity to develop the techniques of music for commercial applications. Skills in the preparation of music for compact disc production, multimedia applications, audio production techniques, songwriting and stage performance will be emphasized.

MUSIC 282
Commercial Music Techniques II
3 UNITS - (CSU)

Lecture 2 hours. Laboratory 2 hours.

Prerequisite: Music 281 with a satisfactory grade or equivalent.

The student continues developing techniques of music for commercial applications. Advanced skills in the preparation of music for compact disc and DVD production, multimedia applications, audio production techniques, songwriting, score realization, stage performance and talent promotion will be emphasized.

MUSIC 285 ARCHIVED

Directed Studies - Music

MUSIC 291
MIDI Instrument Instruction I
2 UNITS - (CSU)

Lecture 1 hour. Laboratory 2 hours.

Prerequisite: Music 161 with a satisfactory grade or equivalent.

Advisory: Music 261.

The student develops functional skills to utilize synthesizers, digital keyboards, sequencers, digital audio interface, MIDI controllers, computers and other MIDI equipment.

MUSIC 292
MIDI Instrument Instruction II
2 UNITS - (CSU)

Lecture 1 hour. Laboratory 2 hours.

Prerequisite: Music 291 with a satisfactory grade or equivalent.

The student continues to develop functional skills to utilize MIDI instruments. Emphasis is on advanced MIDI instrument techniques and applications in creative music technology using both MAC and PC computers.

MUSIC 293
MIDI Instrument Instruction III
2 UNITS - (CSU)

Lecture 1 hour. Laboratory 2 hours.

Prerequisite: Music 292 with a satisfactory grade or equivalent.

The student continues to develop functional skill to utilize MIDI instruments. Emphasis is on advanced techniques in MIDI data, channel-voice messages, MIDI automation and non-registered parameters.

MUSIC 294
MIDI Instrument Instruction IV
2 UNITS - (CSU)

Lecture 1 hour. Laboratory 2 hours.

Prerequisite: Music 293 with a satisfactory grade or equivalent.

The student continues to develop functional skills to utilize MIDI instruments. Emphasis is on advanced techniques in MIDI synchronization with digital audio files and their use.

MUSIC 299
Music Honors
1 UNIT - (RPT 3) (UC:CSU)
Laboratory 3 hours.

Serious music students pursue concentrated study under the direct supervision of an instructor in selected areas through a series of projects designed to increase knowledge of musical aspects pertinent to the student's interests and talents.

MUSIC 300
Introduction to Keyboard Harmony
1 UNIT - (UC:CSU)

Lecture 1 hour.
Co-requisite: Music 200.

The student learns music theory as applied to the piano. Correlated with Music 200. Students are required to furnish their own headphones.

MUSIC 301
Keyboard Harmony I
1 UNIT - (UC:CSU)

Laboratory 2 hours.
Prerequisite: Music 300 with a satisfactory grade or equivalent.
Co-requisite: Music 201.

The student studies diatonic harmony as applied to the piano. Correlated with Music 201.

MUSIC 302
Keyboard Harmony II
1 UNIT - (UC:CSU)

Laboratory 2 hours.
Prerequisite: Music 301 with a satisfactory grade or equivalent.
Co-requisite: Music 202.

The student studies diatonic and simple chromatic harmony applied to the piano. Correlated with Music 202 and 212.

MUSIC 303
Keyboard Harmony III
1 UNIT - (UC:CSU)

Laboratory 2 hours.
Prerequisite: Music 302 with a satisfactory grade or equivalent.
Co-requisite: Music 203.

The student studies advanced chromatic harmony applied to the piano. Correlated with Music 203 and 213.

MUSIC 311
Piano I
1 UNIT - (UC:CSU)

Laboratory 2 hours.
Open to all students.

The student receives instruction in basic piano skills with an emphasis on learning to read music, play finger-patterns, scales, chords, and beginning pieces. Students are required to furnish their own headphones.

MUSIC 312
Piano II
1 UNIT - (UC:CSU)

Laboratory 2 hours.
Prerequisite: Music 311 with a satisfactory grade or equivalent.

The student receives continued instruction in basic piano skills emphasizing note reading, simpler major and minor scales in quarter and eighth note patterns, triads, repertoire and memorization. (If prerequisite is not met, enrollment is subject to audition.)

MUSIC 313
Piano III
1 UNIT - (UC:CSU)

Laboratory 2 hours.
Prerequisite: Music 312 with a satisfactory grade or equivalent.

The student receives continued instruction in developing piano skills with increasing emphasis on note reading, major and minor scale techniques, cadences, triads, repertoire from major historical periods, and memorization. (If prerequisite is not met, enrollment is subject to audition.)

MUSIC 314
Piano IV
1 UNIT - (UC:CSU)

Laboratory 2 hours.
Prerequisite: Music 313 with a satisfactory grade or equivalent.

The student receives instruction in piano skills emphasizing major and minor scales; major and minor arpeggios; repertoire from the Baroque, Classical, Romantic, and 20th Century; and memorization. (If prerequisite is not met, enrollment is subject to audition.)

MUSIC 320
Organ Practice Lab
0.5 UNITS - (RPT 3)

Laboratory 1 hour.
Co-requisite: Either Music 381, 382, 383, or 384.

This course allows students currently enrolled in any of the co-requisite organ classes to use the lab equipment and materials to enhance applicable skills necessary for success.

MUSIC 340
ADVANCED PRACTICE LAB-ORGAN
0.5 UNITS (RPT 3)

Laboratory 1 hour.
Prerequisite: Music 320 or equivalent.
Co-requisite: Either Music 381, 382, 383, or 384.

The student uses departmental organ practice rooms to further enhance applicable skills necessary for success in the co-requisite course. For advanced students who have completed Music 320 four times.

MUSIC 341
Intermediate Piano
2 UNITS - (RPT 3) (UC:CSU)

Lecture 1 hour. Laboratory 2 hours.
Prerequisite: Music 314 with a satisfactory grade or equivalent.

The student studies and performs concert piano literature from the Baroque, Classical, Romantic and Twentieth Century periods. Includes public performance. (If prerequisite is not met, enrollment is subject to audition.)

MUSIC 351
Piano Ensemble
1 UNIT - (RPT 3) (UC:CSU)

Laboratory 2 hours.
 The student reads, studies and performs standard piano ensemble repertoire with special emphasis on performance in recital. (Confirmation of enrollment subject to audition.)

MUSIC 361
Commercial Piano Techniques Workshop
2 UNITS - (RPT 3) (CSU)

Lecture 1 hour. Laboratory 2 hours.
Prerequisite: Music 201 and 313 with a satisfactory grade or equivalent.

The student learns chords and chord progressions used in jazz and popular music styles as applied to the keyboard. Students are required to provide their own headphones. (If prerequisites are not met, enrollment is subject to audition.)

MUSIC 381 ARCHIVED
Elementary Organ I
1 UNIT - (UC:CSU)

MUSIC 382
Elementary Organ II
1 UNIT - (UC:CSU)

MUSIC 383
ELEMENTARY ORGAN III
1 UNIT - (UC:CSU)

MUSIC 384
ELEMENTARY ORGAN IV
1 UNIT - (UC:CSU)

MUSIC 385 ARCHIVED
 Directed Studies - Music

MUSIC 391 ARCHIVED
 Harpsichord I
 1 UNIT - (UC:CSU)

MUSIC 392 ARCHIVED
 Harpsichord II
 1 UNIT - (UC:CSU)

MUSIC 400
Voice Fundamentals
1 UNIT - (UC:CSU)
Laboratory 2 hours.

This course concentrates on general, basic fundamentals of singing, using vocal exercises and simple songs. Emphasis is placed on developing an understanding of the singing voice, the body as a musical instrument, and the vocal potential of each student.

MUSIC 401
Classical Voice I
1 UNIT - (UC:CSU)
Laboratory 2 hours.

Prerequisite: Music 400 with a satisfactory grade or equivalent.

The student concentrates on general basic fundamentals of singing using vocal exercises and simple arias and art songs in Italian. Italian pronunciation and vocal style will be studied. (If prerequisite is not met, enrollment is subject to audition.)

MUSIC 402
Classical Voice II
1 UNIT - (UC:CSU)
Laboratory 2 hours.

Prerequisite: Music 401 with a satisfactory grade or equivalent.

The student learns the basic fundamentals of singing using vocal exercises, simple arias and art songs in German. German pronunciation and vocal style are studied. (If prerequisite is not met, enrollment is subject to audition.)

MUSIC 403
Classical Voice III
1 UNIT - (UC:CSU)
Laboratory 2 hours.

Prerequisite: Music 402 with a satisfactory grade or equivalent.

The student learns the basic fundamentals of singing using vocal exercises, simple arias and art songs in French. French pronunciation and vocal style are studied. (If prerequisite is not met, enrollment is subject to audition.)

MUSIC 420 ARCHIVED
 Music Voice Practice Lab
 0.50 UNITS - (RPT 3)

MUSIC 431
Commercial Voice I
1 UNIT - (CSU)

Laboratory 2 hours.

Prerequisite: Music 400 with a satisfactory grade or equivalent.

The student concentrates on the basic fundamentals of singing using vocal exercises and songs selected from the commercial song literature. Course includes coaching sessions with class accompanist. (If prerequisite is not met, enrollment is subject to audition.)

MUSIC 432
Commercial Voice II
1 UNIT - (CSU)

Laboratory 2 hours.

Prerequisite: Music 431 with a satisfactory grade or equivalent.

The student concentrates on the singing voice using more difficult vocal exercises and songs from the many areas of commercial vocal music. Stylistic interpretation and performance practices are emphasized. Coaching sessions with class accompanist are included. (If prerequisite is not met, enrollment is subject to audition.)

MUSIC 433
Commercial Voice III
1 UNIT - (CSU)

Laboratory 2 hours.

Prerequisite: Music 432 with a satisfactory grade or equivalent.

The more advanced singer concentrates on the study through performance of the stylistic interpretations and performances practices of the many areas of commercial vocal music. Course includes coaching sessions with class accompanist. (If prerequisite is not met, enrollment is subject to audition.)

MUSIC 450 ARCHIVED
 Advanced Practice Lab
 0.5 UNITS - (RPT 3)

MUSIC 453
Musical Theater Repertoire For Singers
1 UNIT - (RPT3) (UC:CSU)

Lecture 1 hour. Laboratory 2 hours.

Prerequisite: Either Music 401 or 431 with a satisfactory grade or equivalent.

The student concentrates on general basic fundamentals of vocal techniques as utilized in musical theater. Additional instruction will include basic body movement, acting techniques and musical theater song literature interpretation. (If prerequisite is not met, enrollment is subject to audition. Bring the music of a prepared song to the first class meeting.)

MUSIC 501
College Choir
1 UNIT - (RPT 3) (UC:CSU)

Laboratory 3 hours.

The student studies and performs selected choral literature for mixed voices. Emphasis is on increased skill in music reading, development of basic voice and ensemble techniques, and improving musicianship.

MUSIC 511 ARCHIVED
 Collegiate Choir
 0.5 UNIT - (RPT 3) (UC:CSU)

MUSIC 520 ARCHIVED
Music Piano Practice Lab
0.5 UNITS - (RPT 3)

MUSIC 521 ARCHIVED
Concert Choir
0.5 UNIT - (RPT 3) (UC:CSU)

MUSIC 531 ARCHIVED
Philharmonic Choir
1 UNIT - (RPT 3) (UC:CSU)

MUSIC 540 ARCHIVED
Advanced Practice Lab – Piano
0.5 UNITS - (RPT 3)

MUSIC 561
Chamber Chorale
1 UNIT - (RPT 3) (UC:CSU)
Laboratory 3 hours.

The student analyzes, rehearses and performs choral music suited to a small group of singers, with and without accompaniment. Emphasis is on increased skill in reading music and sight singing, score interpretation, vocal technique, diction, and preparation for public performances. (Confirmation of enrollment subject to audition.)

MUSIC 601
Brass Instrument Instruction I
2 UNITS - (UC:CSU)
Lecture 1 hour. Laboratory 2 hours.

The student receives basic instruction on the brass instruments, including trumpet, French horn, trombone and tuba. Some instruments available to loan to enrolled students. Open to all students.

MUSIC 602
Brass Instrument Instruction II
2 UNITS - (UC:CSU)
Lecture 1 hour. Laboratory 2 hours.
Prerequisite: Music 601 with a satisfactory grade or equivalent.
The student continues brass instrument instruction with emphasis on the development of embouchure, range, endurance and music reading skills. Some instruments available to loan enrolled students. (If prerequisite is not met, enrollment is subject to audition.)

MUSIC 603
Brass Instrument Instruction III
2 UNITS - (UC:CSU)
Lecture 1 hour. Laboratory 2 hours.
Prerequisite: Music 602 with a satisfactory grade or equivalent.
The student continues brass instrument instruction with increased emphasis in all areas covered. Primary emphasis is on interpretation of more complex rhythmic notation and performance skills. Some instruments available to loan to enrolled students. (If prerequisite is not met, enrollment is subject to audition.)

MUSIC 604
Brass Instrument Instruction IV
2 UNITS - (UC:CSU)
Lecture 1 hour. Laboratory 2 hours.
Prerequisite: Music 603 with a satisfactory grade or equivalent.
The student continued brass instrument instruction with

increased emphasis in all areas covered. Primary emphasis is on interpretation of solo and small ensemble literature. Some instruments available to loan to enrolled students. (If prerequisite is not met, enrollment is subject to audition.)

MUSIC 611
String Instrument Instruction I
2 UNITS - (UC:CSU)
Lecture 1 hour. Laboratory 2 hours.

The student receives basic instruction on the string instruments, either violin, viola, cello or bass. Some instruments available to loan to enrolled students. Open to all students.

MUSIC 612
String Instrument Instruction II
2 UNITS - (UC:CSU)
Lecture 1 hour. Laboratory 2 hours.
Prerequisite: Music 611 with a satisfactory grade or equivalent.

The student learns more advanced string instrument techniques with increased emphasis in all areas covered. Primary emphasis is on development of bow and fingering techniques and music reading skills. Some instruments available to loan to enrolled students. (If prerequisite is not met, enrollment is subject to audition.)

MUSIC 613
String Instrument Instruction III
2 UNITS - (UC:CSU)
Lecture 1 hour. Laboratory 2 hours.
Prerequisite: Music 612 with a satisfactory grade or equivalent.

The student learns more advanced string instrument techniques with increased emphasis in all areas covered. Primary emphasis is on development of bow and fingering technique in third position and music reading skills. Some instruments available to loan to enrolled students. (If prerequisite is not met, enrollment is subject to audition.)

MUSIC 614
String Instrument Instruction IV
2 UNITS - (UC:CSU)
Lecture 1 hour. Laboratory 2 hours.
Prerequisite: Music 613 with a satisfactory grade or equivalent.

The student learns more advanced string instrument techniques with increased emphasis in all areas covered. Primary emphasis is on interpretation of advanced solo and small ensemble literature. Some instruments available to loan to enrolled students. (If prerequisite is not met, enrollment is subject to audition.)

MUSIC 620
Instrumental Practice Lab
0.5 UNITS - (RPT 3)
Laboratory 1 hour.
Co-requisite: Either Music 101, 130, 146, 147, 181, 182, 183, 184, 185, 250, 251, 299, 311, 312, 311, 312, 313, 314, 341, 351, 361, 400, 401, 402, 403, 431, 432, 433, 453, 501, 561, 601, 602, 603, 604, 611, 612, 613, 614, 621, 622, 623, 624, 650, 651, 652, 653, 654, 670, 705, 711, 725, 751, 771 or 781.
This course allows students currently enrolled in any of the co-requisite instrumental classes to use the lab equipment and materials to enhance applicable skills necessary for success.

MUSIC 621
Woodwind Instrument Instruction I
2 UNITS - (UC:CSU)

Lecture 1 hour. Laboratory 2 hours.

The student learns basic woodwind instrument techniques. Includes flute, oboe, clarinet, bassoon and saxophone. Some instruments available to loan to enrolled students. Open to all students.

MUSIC 622
Woodwind Instrument Instruction II
2 UNITS - (UC:CSU)

Lecture 1 hour. Laboratory 2 hours.

Prerequisite: Music 621 with a satisfactory grade or equivalent.

The student learns more advanced woodwind instrument techniques with increased emphasis in all areas covered. Primary emphasis is on embouchure development, range, endurance and music reading skills. Some instruments available to loan to enrolled students. (If prerequisite is not met, enrollment is subject to audition.)

MUSIC 623
Woodwind Instrument
Instruction III
2 UNITS - (UC:CSU)

Lecture 1 hour. Laboratory 2 hours.

Prerequisite: Music 622 with a satisfactory grade or equivalent.

The student learns more advanced woodwind instrument techniques with increased emphasis in all areas covered. Primary emphasis is on interpretation of more complex rhythmic notation and performance skills. Some instruments available to loan to enrolled students. (If prerequisite is not met, enrollment is subject to audition.)

MUSIC 624
Woodwind Instrument
Instruction IV
2 UNITS - (UC:CSU)

Lecture 1 hour. Laboratory 2 hours.

Prerequisite: Music 623 with a satisfactory grade or equivalent.

The student learns more advanced woodwind instrument techniques with increased emphasis in all areas covered. Primary emphasis is on interpretation of advanced solo and small ensemble literature. Some instruments available to loan to enrolled students. (If prerequisite is not met, enrollment is subject to audition.)

MUSIC 631
Percussion Instrument
Instruction I
2 UNITS - (UC:CSU)

Lecture 1 hour. Laboratory 2 hours.

The student learns basic rhythms, rudiments, beginning notation and meters as applied to the snare drum and related percussion instruments.

MUSIC 632
Percussion Instrument Instruction II
2 UNITS - (UC:CSU)

Lecture 1 hour. Laboratory 2 hours.

Prerequisite: Music 631 with a satisfactory grade or equivalent.

The student continues with basic rhythms, rudiments, beginning notation and meters as applied to the snare drum and related percussion instruments. (If prerequisite is not met, enrollment is subject to audition.)

MUSIC 633
Percussion Instrument Instruction III
2 UNITS - (UC:CSU)

Lecture 1 hour. Laboratory 2 hours.

Prerequisite: Music 632 with a satisfactory grade or equivalent.

The student receives intermediate instruction on percussion instruments and develop greater skill in the reading of percussion notation and in the playing of drum set. (If prerequisite is not met, enrollment is subject to audition.)

MUSIC 634
Percussion Instrument Instruction IV
2 UNITS - (UC:CSU)

Lecture 1 hour. Laboratory 2 hours.

Prerequisite: Music 633 with a satisfactory grade or equivalent.

The advanced student develops greater skill in the reading of percussion notation and in the playing of drum set as it relates to contemporary funk styles. (If prerequisite is not met, enrollment is subject to audition.)

MUSIC 640
Advanced Practice lab - Instrumental
0.5 UNITS - (RPT 3)

Laboratory 1 hour.

Prerequisite: Music 620 or equivalent.

Co-requisite: Either Music 101, 130, 146, 147, 181, 182, 183, 184, 185, 250, 251, 299, 311, 312, 311, 312, 313, 314, 341, 351, 361, 400, 401, 402, 403, 431, 432, 433, 453, 501, 561, 601, 602, 603, 604, 611, 612, 613, 614, 621, 622, 623, 624, 650, 651, 652, 653, 654, 670, 705, 711, 725, 751, 771 or 781.

The student uses departmental practice rooms to further enhance applicable skills necessary for success in the co-requisite course. For advanced students who have completed Music 620 four times.

MUSIC 650
Beginning Guitar
2 UNITS - (UC:CSU)

Lecture 1 hour. Laboratory 2 hours.

(Student must provide own guitar.)

The student learns basic positioning of body and hands, music notation and reading, finger picking and chord accompaniment. Designed for students with no previous musical training. Student must provide own guitar.

MUSIC 651
Classical Guitar I
2 UNITS - (UC:CSU)

Lecture 1 hour. Laboratory 2 hours.

Prerequisite: Music 650 with a satisfactory grade or equivalent.

(Student must provide own guitar.)

The student reinforces fundamental music reading, right and left hand playing techniques and performance of elementary solo guitar compositions. For students who wish to continue beyond the beginning level. Student must provide own guitar. (If prerequisite is not met, enrollment is subject to audition.)

MUSIC 652
Classical Guitar II
2 UNITS - (UC:CSU)

Lecture 1 hour. Laboratory 2 hours.

Prerequisite: Music 651 with a satisfactory grade or equivalent.

(Student must provide own guitar.)

The student performs intermediate level exercises and solos. For students who want to progress further into more technically demanding compositions. Student must provide own guitar. (If prerequisite is not met, enrollment is subject to audition.)

MUSIC 653
Classical Guitar III
2 UNITS - (UC:CSU)

Lecture 1 hour. Laboratory 2 hours.

Prerequisite: Music 652 with a satisfactory grade or equivalent.
 (Student must provide own guitar.)

The student performs compositions of greater harmonic and technical complexity. For intermediate to advanced students who wish to probe deeper into analysis and performance practices of the classical guitarist. Student must provide own guitar. (If prerequisite is not met, enrollment is subject to audition.)

MUSIC 654
Classical Guitar IV
2 UNITS - (UC:CSU)

Lecture 1 hour. Laboratory 2 hours.

Prerequisite: Music 653 with a satisfactory grade or equivalent.
 (Student must provide own guitar.)

The student analyzes, prepares and performs advanced compositions for classical guitar, incorporating the full range of classical guitar techniques. Musicianship and aesthetics of music are considered in depth. Ensembles of various sizes prepare and perform music from all eras.

MUSIC 670
Fingerboard Harmony
2 UNITS - (CSU)

Lecture 1 hour. Laboratory 2 hours.

Prerequisite: Music 651 with a satisfactory grade or equivalent.
 (Student must provide own guitar.)

The student furthers their understanding of chord construction and progressions of the guitar. (If prerequisite is not met, enrollment is subject to audition.)

MUSIC 705
Chamber Music
1 UNIT - (RPT 3) (UC:CSU)

Laboratory 3 hours.

The student reads, studies and performs standard chamber music repertoire with special emphasis on preparing for recital. (Confirmation of enrollment subject to audition.)

MUSIC 711
Rehearsal Orchestra
1 UNIT - (RPT 3) (UC:CSU)

Laboratory 3 hours.

The orchestra player of intermediate ability who wishes to become more proficient on a secondary orchestra instrument performs intermediate orchestral music with an emphasis on the development of competence and ensemble skill. (Confirmation of enrollment subject to audition.)

MUSIC 720 ARCHIVED
 Music Ensemble Practice Lab
 0.5 UNITS - (RPT 3)

MUSIC 725
Community Orchestra
1 UNIT - (RPT 3) (UC:CSU)

Laboratory 3 hours.

The student reads, studies and performs standard orchestral repertoire with special emphasis on performance of major orchestral works. Practical experience may also be offered to capable student conductors, soloists, composers and arrangers. (Confirmation of enrollment subject to audition.)

MUSIC 731 ARCHIVED
 Rehearsal Band
 0.5 UNIT - (RPT 3) (UC:CSU)

MUSIC 740 ARCHIVED
 Advanced Practice Lab – Music Ensemble
 0.5 UNITS - (RPT 3)

MUSIC 751
Wind Ensemble
1 UNIT - (RPT 3) (UC:CSU)

Laboratory 3 hours.

The student studies standard band literature with the intent to develop technical and artistic abilities through experiences with a wide range of band literature. Public performances are presented. (Confirmation of enrollment subject to audition.)

MUSIC 765
Percussion Ensemble
1 UNIT - (RPT 3) (UC:CSU)

Laboratory 3 hours.

The student studies and performs standard percussion ensemble literature in the symphonic and commercial fields emphasizing proper execution of musical styles, phrasing, balance and blending techniques, intonation, rehearsal and performance techniques. (Confirmation of enrollment subject to audition.)

MUSIC 771
Guitar Ensemble
1 UNIT - (RPT 3) (UC:CSU)

Laboratory 3 hours.

The student studies and performs standard guitar ensemble literature with emphasis on intonation, rhythmic togetherness, balance, style, and the requirements of effective ensemble playing. (Enrollment in class subject to audition.)

MUSIC 775 ARCHIVED
 Jazz Ensemble
 0.5 UNIT - (RPT 3) (UC:CSU)

MUSIC 781
Studio Jazz Band
1 UNIT - (RPT 3) (UC:CSU)

Laboratory 4 hours.

The student receives training and experience in the various aspects of technique and interpretation as applied to jazz band performance. Includes public performance and recording experience. For intermediate to advanced players.

MUSIC 820
Percussion Practice Lab
0.5 UNITS - (RPT 3)

Laboratory 1 hour.

Co-requisite: Either Music 631, 632, 633, 634 or 765.

This course allows students currently enrolled in any of the co-requisite percussion classes to use the lab equipment and materials to enhance applicable skills necessary for success.

MUSIC 840
Advanced Practice Lab – Percussion
0.5 UNITS - (RPT 3)

Laboratory 1 hour.

Prerequisite: Music 820 or equivalent.

Co-requisite: Either Music 631, 632, 633, 634 or 765.

The student uses departmental percussion practice rooms to further enhance applicable skills necessary for success in the co-requisite course. For advanced students who have completed Music 820 four times.

NURSING, REGISTERED

NURSING, REGISTERED 103

Nursing Pharmacology 1 UNIT – (CSU)

Lecture 1 hour.

Prerequisite: Admission to Nursing program.

Co-requisite: Nursing, Registered 104.

First semester nursing students acquire introductory knowledge about the most frequently prescribed medications, their side effects, and possible interactions that are used in health care setting today.

NURSING, REGISTERED 104

Nursing Foundations 4 UNITS – (CSU)

Lecture 2 hours. Laboratory 6 hours.

Prerequisite: Math 115, English 101, Sociology 1, Speech 101, Psych 1, 41, Physiology 1, Anatomy 1 and Microbiology 20.

Students acquire introductory knowledge about theoretical concepts and fundamental skills in nursing that are required for safe patient care. Students also learn and apply the Roy Adaptation Model nursing process as the conceptual framework for practice. Then students develop enhanced critical thinking and psychomotor skills during the clinical component.

NURSING, REGISTERED 105

Beginning Medical-Surgical Nursing 5 UNITS – (CSU)

Lecture 2.5 hours. Laboratory 7.5 hours.

Prerequisite: Nursing, Registered 104 with a satisfactory grade.

Students acquire enhanced knowledge about the Roy Adaptation Model nursing process and implement this as the framework for nursing care. Students also develop introductory knowledge and understanding of common medical-surgical health problems. Additionally, students apply theoretical concepts and nursing skills in a clinical setting.

NURSING, REGISTERED 106

Nursing Care of the Childbearing Family 4 UNITS – (CSU)

Lecture 2 hours. Laboratory 6 hours.

Prerequisite: Nursing, Registered 105 with a satisfactory grade.

Utilizing the Roy Adaptation model and the nursing process, the students in Nursing Care of the Childbearing Family focus on nursing care of culturally diverse families experiencing reproductive health, childbearing, and breast and reproductive cancers. The students apply concepts that include disease process, medical treatments, nursing responsibilities, and interventions, cultural, ethical, and legal issues to the childbearing family.

NURSING, REGISTERED 107

Nursing Care of the Pediatric Client 4 UNITS – (CSU)

Lecture 2 hours. Laboratory 6 hours.

Prerequisite: Nursing, Registered 105 with a satisfactory grade.

Utilizing the Roy Adaptation Model and the nursing process, students will focus on the nursing care of children of various ages and their families. The student applies concepts that include disease process, medical treatments, nursing responsibilities, and interventions, cultural, ethical, and legal issues to the pediatric population.

NURSING, REGISTERED 108

Nursing Care of the Client with Psychosocial Needs 4 UNITS – (CSU)

Lecture 2 hours. Laboratory 6 hours.

Prerequisite: Nursing, Registered 107 with a satisfactory grade and approved second year status in RN program.

The student receives correlated theoretical knowledge and clinical experience in the care of the psychiatric patient in the acute care facility. Emphasis will be on the holistic care of clients with mental health problems, cognitive disorders, and/or difficulties in coping with problems of daily living.

NURSING, REGISTERED 109

Intermediate Medial-Surgical Nursing 5 UNITS – (CSU)

Lecture 2.5 hours. Laboratory 7.5 hours.

Prerequisite: Nursing, Registered 106 and Nursing, Registered 107 with a satisfactory grade and approved second year status in RN program.

The student will apply theoretical concepts and clinical skills to address the needs of the adult and older adult client with increasingly complex medical- surgical health problems. Students will focus on the bio-psycho-social impact of illness across the life span and nursing interventions to promote client adaptation. Students will participate in concurrent clinical experience.

NURSING, REGISTERED 110

Advanced Medical-Surgical Nursing 5 UNITS - (CSU)

Lecture 2.5 hours. Laboratory 7.5 hours.

Prerequisite: Nursing, Registered 108 and Nursing, Registered 109 with a satisfactory grade.

In this advanced nursing course, students understand and apply advanced theoretical and clinical concepts in the care of medical-surgical patients with complex problems. Student acquires translational knowledge about complex concepts that include ECG monitoring, beginning ventilatory management, hemodynamic monitoring, care of the client with multisystem failure, and nursing care in emergency situations. Students will apply theoretical knowledge across all specialty care settings.

NURSING, REGISTERED 111
Nursing Leadership and Management
4 UNITS - (CSU)

Lecture 2 hours. Laboratory 6 hours.

Prerequisite: Nursing, Registered 110 with a satisfactory grade.

Students explore, and apply the legal, ethical and current issues and trends that affect the Registered Nurse today within the context of the Roles of Practice. Students will complete a 108 clinical preceptor ship in an acute care setting.

NURSING, REGISTERED 115
Nursing Skills Competency I
1 UNIT - (CSU)

Laboratory 3 hours.

Co-requisite: Nursing, Registered 104.

Students practice procedures and skills learned in concurrent Fundamentals and Beginning Medical-Surgical Nursing theory and clinical courses

NURSING, REGISTERED 116
Nursing Skills Competency II
1 UNIT - (CSU)

Laboratory 3 hours.

Prerequisite: Nursing, Registered 105 with a satisfactory grade.

The student participates in this weekly 3 hour adjunct, laboratory course to practice procedures and skills learned in concurrent Fundamentals and Beginning Medical-Surgical Nursing theory and clinical courses.

NURSING, REGISTERED 117
Nursing Skills Competency III
1 UNIT - (CSU)

Laboratory 3 hours.

Prerequisite: Nursing, Registered 107 with a satisfactory grade and approved second year status in RN program.

Third semester nursing students practice and enhance both mental health and medical-surgical nursing skills.

NURSING 329
Role Transition LVN to RN
(When Available)
2 UNITS

Lecture 2 hours.

This course is offered in two modules: NURSING 329 A AND B.

The Licensed Vocational Nurse will develop necessary skills to make a successful transition to the role of RN student to pursue an RN license. The student will develop and implement skills sets that include role transition, learning styles, dosage calculations, heart, lung and bowel assessment. Styles, dose calculations, heart, lung and bowel assessment.

RN RESIDENCY IN PEDIATRICS
NURSING, REGISTERED 150
Expanded Practice and Principles for Pediatric
Nursing I
9 UNITS

Lecture 6 hours. Laboratory 9 hours.

Prerequisite: Nursing, Registered 111 with a satisfactory a satisfactory grade.

The student will participate in competency assessment in the progression from novice graduate to Registered Nurse in the Pediatric Nursing specialty.

NURSING, REGISTERED 151
Role Development in Pediatric Nursing
8 UNITS

Lecture 3 hours. Laboratory 15 hours.

Prerequisite: Nursing, Registered 150 with a satisfactory grade.

The student will progress in role development, under preceptor guidance, from novice toward increased clinical competency in the Pediatric Nurse Residency Program.

NURSING, REGISTERED 152
Expanded Practice and Principles for Pediatric
Nursing II
7 UNITS

Lecture 3 hours. Laboratory 12 hours.

Prerequisite: Nursing, Registered 151 with a satisfactory grade.

The student will progress toward leadership and independent practice as a specialty Pediatric Nurse.

CNA NURSING NURSING 100
Certified Nurse Assistant ARCHIVED
6 UNITS - (A)

HOME HEALTH AID NURSING 101
Home Health Aids
2 UNITS - NDC

Prerequisite: Nursing 100 with a satisfactory grade.

This course provides instruction in: 1) Introduction to aide and Agency Role; 2) Interpretation of medical and social needs of people being served; 3) Personal care services; 4) Nutrition; 5) Cleaning and care tasks in home.

OCEANOGRAPHY

OCEANOGRAPHY 1
Introduction To Oceanography
3 UNITS - (UC:CSU)

Lecture 3 hours

Advisory: English 28 and 67 or equivalent.

The student receives a general introduction to the origin of the universe, plate tectonics, ocean basins, water, beaches, tides, and the overall uses and abuses of the ocean by human beings.

PARALEGAL (SEE LAW)

PERSONAL DEVELOPMENT

EDUCATION 101 ARCHIVED
Learning Strategies for College Success Laboratory
1 UNIT – (CSU)

PERSONAL DEVELOPMENT 20 Post Secondary Education: The Scope of Career Planning 3 UNIT – (CSU)

Advisory: Eligibility for ENGLISH 28 and 67 or equivalent

This course is designed to assist students with self-exploration, career transitions, career-life planning and employment readiness skills in order to achieve success in a diverse society. Critical thinking skills will be utilized through a systematic approach to career development by examining values, interests, skills, life roles, personality type, personal self-management, decision-making and goal-setting throughout the life span.

PERSONAL DEVELOPMENT 40 College Success Seminar 3 UNIT – (UC:CSU)

Advisory: Eligibility for English 28 and 67 or equivalent

This course will explore issues related to higher education that impact student success. Topics will include an overview of academic success skills, value and purpose of higher education. Los Angeles City College and Los Angeles Community College District policies and procedures, ethics and responsibility, diversity in higher education, educational strategies and planning, interpersonal communication, career development, health issues, and self-assessment techniques. Skills, value and purpose of higher education. Los Angeles City College and Los Angeles Community College District policies and procedures, ethics and responsibility, diversity in higher education, educational strategies and planning, interpersonal communication, career development, health issues, and self-assessment techniques.

PERSONAL DEVELOPMENT 41 Introduction to Higher Education 1 UNIT – (CSU)

This course introduces the Master Plan for Higher Education in California, as well as higher education systems in other states. Included will be discussions of general educational policies, requirements for transfer and the Associate of Arts degree, differences among various higher education systems, specifically in California. Students will develop a plan in order to accomplish their future educational goals.

PERSONAL DEVELOPMENT 101 ARCHIVED
Learning Strategies for College Success
2 UNITS – (CSU)

PHILOSOPHY

PREREQUISITES: Specified prerequisites must be completed with a satisfactory grade or equivalent for Philosophy 1H and Philosophy 5.
All classes fulfill the Humanities requirement for the Associate in Arts degree except Philosophy 6, 7, 8 and 9, which fulfill the Language and Rationality requirement.

PHILOSOPHY 1 Introduction to Philosophy I 3 UNITS – (UC:CSU)

Lecture 3 hours.

This introductory course is open to all students. The following questions will be discussed: Does life have meaning? Does God exist? Do we have free will? Can we trust our senses?

PHILOSOPHY 1H ARCHIVED
Introduction to Philosophy 1H
3 UNITS – (UC:CSU)

PHILOSOPHY 2 Society And Values 3 UNITS – (UC:CSU)

Lecture 3 hours.

The class focuses upon various theories of human nature and the implications of such theories for social, political and moral issues. The views of thinkers such as Plato, Marx, Freud, and Sartre are studied.

PHILOSOPHY 5 Critical Thinking and Composition 3 UNITS – (UC:CSU)

Lecture 3 hours.

Prerequisite: ENGLISH 101 with a satisfactory grade or better or equivalent.

This class develops critical thinking skills necessary for evaluating and formulating argumentative/persuasive essays. Instruction in writing is a central focus of this course.

PHILOSOPHY 6 Logic in Practice 3 UNITS – (UC:CSU)

Lecture 3 hours.

This course in critical thinking is intended to develop understanding of logical principles and their application to everyday life in such areas as advertising, news reports, editorials, etc.

PHILOSOPHY 7 ARCHIVED
Inductive Logic
3 UNITS – (UC:CSU)

PHILOSOPHY 8 Deductive Logic 3 UNITS – (UC:CSU)

Lecture 3 hours.

This introductory logic class, which is open to all students, is designed to develop the student's ability to think critically and to reason correctly. Attention will be given to both formal and informal logic.

PHILOSOPHY 9**Symbolic Logic I****3 UNITS – (UC:CSU)***Lecture 3 hours.*

The student learns to translate, analyze and evaluate arguments in modern symbolic logic by employing the principles and methods of propositional and predicate logic.

PHILOSOPHY 12**History of Greek Philosophy****3 UNITS – (UC:CSU)***Lecture 3 hours.*

The history of Greek philosophic thought is examined through the works of the Greek oral poets, the Pre Socratics, Socrates and the systems of Plato and Aristotle.

PHILOSOPHY 14**History of Modern European Philosophy****3 UNITS – (UC:CSU)***Lecture 3 hours.*

This class traces the development of the ideas which shape the modern mind. The individual's relationship to the state, to his fellow human beings and to the universe will be explored in the works of modern philosophers.

PHILOSOPHY 19 ARCHIVED

Contemporary Problems in Bio Ethics

3 UNITS – (UC:CSU)

PHILOSOPHY 20**Ethics****3 UNITS – (UC:CSU)***Lecture 3 hours.*

This class offers a study of both historical and contemporary ethical theories as well as a discussion and analysis of current moral issues.

PHILOSOPHY 30**Asian Philosophy****3 UNITS – (UC:CSU)***Lecture 3 hours.*

This course explores the major philosophies of India, China and Japan, including Hinduism, Buddhism, Confucianism, Taoism and Zen Buddhism. Consideration is given to the differences between Eastern and Western thought.

PHILOSOPHY 32**Philosophy of Religion (formerly Philosophy 27)****3 UNITS – (UC:CSU)***Lecture 3 hours.*

Offers an exposition, discussion and analysis of significant philosophical questions which have been directed at religious beliefs.

PHILOSOPHY 35**Judaism, Christianity and Islam****3 UNITS – (UC:CSU)***Lecture 3 hours.*

An examination of the philosophical and theological ideas of the three great shaping religious traditions of our culture.

PHILOSOPHY 40**Introduction To The Philosophy of Art****3 UNITS – (UC:CSU)***Lecture 3 hours.*

Various philosophical theories regarding the nature of art, “beauty”, and the aesthetic experience will be examined in this course.

PHILOSOPHY 41 ARCHIVED

Introduction to Philosophy And Literature

3 UNITS – (UC:CSU)

PHOTOGRAPHY**PHOTOGRAPHY 1****Elementary Photography****6 UNITS - (CSU)***Lecture 3 hours, Laboratory 9 hours.*

Prerequisite: Photography 10 with a satisfactory grade, or approval of Black and White portfolio of 10 to 15 prints, by instructor, which must be presented to the instructor during semester previous to semester of enrollment. All work in the portfolio, including processing, must be by the student.

Advisory: Photography 28.

The beginning course for Photography majors, with intensive training in all phases of professional techniques, emphasizing view camera operation, exposure and development control of film, printing for optimum technical and aesthetic values, basic lighting techniques, theory of photographic processes, and basic sensitometry. Estimated material cost is approximately \$225. Owning a professional quality light meter is recommended. Owning medium format or 4x5 camera equipment is not essential.

PHOTOGRAPHY 3**Basic Commercial Fields****6 UNITS - (A)***Lecture 3 hours, Laboratory 9 hours.**Prerequisite:* Photography 1 with a satisfactory grade.*Advisory:* Photography 28.

Students learn intermediate professional lighting techniques for commercial photography. Specialized assignments related to current professional commercial photography requirements and practices will be assigned. Intermediate concept, design, and specialization in lighting for commercial advertising are emphasized. Introduction to professional studio strobes and accessories and continued use of professional cameras – film and digital – will be used for assignments.

PHOTOGRAPHY 6**Advanced Commercial Photography****3 UNITS – (RPT 1) (CSU)***Lecture 2 hours. Laboratory 3 hours.**Prerequisite:* Photography 3 with a satisfactory grade.*Advisory:* Photography 33 or equivalent

Students learn advanced professional lighting techniques for commercial photography. Specialized assignments related to current professional commercial photography methods and business practices will be assigned. Concept and design, and specialization in lighting for commercial advertising is emphasized. Applied professional photographic techniques, and projects will culminate in a working portfolio. Continued study in the use of professional film, digital cameras and software, strobes and accessories - in studio and on location will be emphasized.

PHOTOGRAPHY 7
Exploring Digital Photography
3 UNITS

Advisory: English 28 and 67/31 or equivalent

An introductory course in the uses and applications of professional digital SLR cameras. Camera controls, elements of composition, and photographing with natural light will be stressed. Professional digital cameras may be provided by the department for student usage. Students may use their own cameras to supplement assignments. Owning a digital camera is not a requirement but is highly recommended.

PHOTOGRAPHY 10
Beginning Photography
3 UNITS - (UC: CSU)

Lecture 2 hours, Laboratory 3 hours.

Advisory: Concurrent enrollment in Photography 28 and English 28 and 67 or equivalent.

Basic principles of photography from the mechanical creation of the image with camera and film to enlarging the photograph for display, while applying the guidelines of composition, communication and self-expression. 35 mm single lens camera required. Automatic cameras are OK, but they must have manual shutter speed and lens opening capability. An approximate supply cost is \$125. You must attend the first lecture meeting, or be replaced by students wishing to add. The first scheduled class is the first lecture meeting. Do not attend the first lab meeting. Labs will meet only after announced in lecture class.

PHOTOGRAPHY 15
Fundamentals of Portraiture
3 UNITS - (CSU)

Lecture 2 hours. Laboratory 3 hours.

Prerequisite: Photography 1 with a satisfactory grade.
Advisory: Concurrent enrollment in Photography 28.

This course offers a study of modern photographic lightings in portraiture, using professional cameras and lighting equipment. Photographic films, exposure factors, developing techniques, and print display are presented. Lightings for groups, environmental portraiture and posing techniques are studied as well.

PHOTOGRAPHY 17
Introduction to Color Photography
3 UNITS - (CSU)

Lecture 2 hours. Laboratory 3 hours.

Prerequisite: Photography 10 with a satisfactory grade.
Advisory: Photography 28 and English 28 and 67 or equivalent.

This is a course in traditional color printing from color negatives. There is an emphasis on color correction and color theory. Natural light and available light and their characteristics are studied in order to better understand perception and the individual's interpretation of color as seen and photographed. Students must have access to a 35mm manual camera. Estimated cost of materials is approximately \$130.

PHOTOGRAPHY 20
Beginning Photojournalism
4 UNITS - (CSU)

Lecture 2 hours. Laboratory 6 hours..

Prerequisite: Photography 7

Advisory: Photography 28

Students learn photography for publications, including magazines, wire services, print and online newspapers and campus publications. The primary emphasis is on digital photography and its use in the journalism and publication worlds. Students practice using cameras and computers, correctly applying the techniques of instruction to photo journalistic methods and visual news gathering.

PHOTOGRAPHY 22
Creative Photo-Vision
3 UNITS - (RPT 2) (A)

Lecture 2 hours. Laboratory 3 hours.

Prerequisite: Photography 1 with a satisfactory grade.

Advisory: Photography 28.

Designed as a workshop in sensitive seeing, this course offers photography students some of the avenues of self-expression through nontraditional photographic techniques including non-silver processes, collage, hand-coloring, serial imagery and other alternative processes.

PHOTOGRAPHY 28
Laboratory Processes
1 UNIT - (RPT 3) (A)

Laboratory 3 hours.

Advisory: English 28 and 67 or equivalent.

This course is designed for the photography student who wishes to increase laboratory skills, relative to concurrent photography classes, through extended contact with equipment and faculty. Students will not be permitted to use any of the photo lab facilities if they drop or are excluded from the main photo lecture section.

PHOTOGRAPHY 33
Advanced Laboratory Processes
1 UNIT - (RPT 3) (A)

Laboratory 3 hours.

Prerequisite: Photography 28 with a satisfactory grade.

Co-requisite: Photography 3 or 6 or 15 or 22.

Students, while concurrently enrolled in an advanced primary lecture class, demonstrate the ability to follow directions and advanced technical recommendations of their photography instructors while working in the photography laboratory including black and white, color, and digital facilities. Students must adhere to safety procedures and guidelines of the laboratory setting.

PHOTOGRAPHY 34
History of Photography
3 UNITS - (UC:CSU)

Lecture 3 hours.

Advisory: English 28 and 67 or equivalent

Students recognize and identify the major historical developments of in photography including major technological inventions and advancements, styles and movements, and important photographers from 1826 through 1960. Special attention is paid to the impact of the photographic image and how it has shaped modern art and culture worldwide.

PHOTOGRAPHY 46
Photographic Digital Imaging {Adobe Photoshop}
3 UNITS - (A)

Lecture 2 hours. Laboratory 3 hours.

Students learn introductory digital imaging which will incorporate the use of computers and photographic digital software to alter, enhance, and create new images that can be output to print and digital media. The basic operations, functions, and applications of Adobe Photoshop will be covered. Detailed instruction and specialized assignments integrate digital image manipulation, compositing/collaging, editing and other practical tools.

PHOTOGRAPHY 49**Advanced Photographic Digital Imaging****6 UNITS - (CSU)**

Lecture 3 hours. Laboratory 9 hours.

Prerequisite: Photography 46 with a satisfactory grade.

(see "Health Advisory" under Certificate Programs)

Students learn advanced digital imaging/Photoshop techniques which will incorporate the use of computers and photographic digital software to alter, enhance, and create new images that can be output to print and digital media. Detailed instruction in the application of Adobe Photoshop will be covered. Development of concept and design, and the use of photographic images are emphasized. Creation of specialized projects will integrate digital image manipulation, compositing/collaging, retouching, editing and other specialized Photoshop techniques.

PHOTOGRAPHY 50**Specialty Fields****3 UNITS - (RPT 3) (A)**

Laboratory 9 hours.

Prerequisite: Photography 1 or 207 with a satisfactory grade or instructor's approval of advanced level portfolio.

The advanced student contracts with the instructor to produce an independent study photography project that is the basis of a free-lance, photo journalistic, commercial or fine art photographic portfolio. The student designs a portfolio based on individual concepts and goals under the guidance of the instructor.

PHOTOGRAPHY 107**Intermediate Digital Photography****3.00 UNITS**

Lecture 2 hours. Laboratory 3 hours.

PREREQUISITE: Photo 7 and Photo 46.

An in-depth course in the workflow of professional digital photography. RAW capture, processing, color management, archiving, transferring files, and printing will be stressed. Students will also explore studio lighting using tungsten lights and will develop a portfolio demonstrating technical and aesthetic proficiency. A limited number of professional digital cameras may be provided by the department for student usage. Owning a digital SLR camera is not a requirement but is highly recommended.

PHOTOGRAPHY 207**Advanced Digital Photography****3.00 UNITS**

Lecture 2 hours. Laboratory 3 hours.

PREREQUISITE: Photo 107.

Advisory: Photography 28

An advanced course in the technical and practical aspects of professional digital photography. Topics will include: advanced RAW processing, advanced archiving, advanced digital SLR techniques, electronic flash for the studio and on location, as well as digital tech training including Phase One software and the medium format digital back. Additionally, students will learn self-promotion techniques, practice professionalism in the photographic industry, and create a working portfolio.

PHYSICAL EDUCATION

With the exception of contact sports, all activity and theory classes are open to both men and women. Individual courses are open to both men and women. Individual courses, Physical Education 96 through 480, may be repeated for credit. UC limit: Physical Education 96 399, any or all of these courses combined: maximum credit allowed, 4 units; 401-480, any or all of these courses combined: maximum Credit allowed, 4 units; 503-516, any or all of these courses combined: maximum credit allowed 4 units; 710-711; 713-720, any or all of these courses combined: maximum credit allowed 8 units. Physical Education 185, 285, 385: depending on course content apply appropriate.

Independent Study Limit.

Advisory: English 28 and 67/31 or its equivalent or concurrent enrollment in Learning Skills 1, 7, and Speech Communication 113 for all Transfer Theory courses.

PHYSICAL EDUCATION 101-142**Water Activities - Swimming****1 UNIT - (RPT 3) (UC:CSU)**

Activity 2 hours.

Beginning, intermediate and advanced levels offered for all swim courses.

PHYSICAL EDUCATION 101**Water Activities - Non-Swimmer****1 UNIT - (RPT 3) (UC:CSU)**

Laboratory 2 hours.

Beginning, intermediate, and advanced level offered for all swim classes.

PHYSICAL EDUCATION 102**Water Activities - Swimming Skills****1 UNIT - (RPT 3) (UC:CSU)**

Laboratory 2 hours.

Students learn swimming skills. Skills for each stroke include kicking, arm stroke, proper breathing techniques, body position, and rhythm of stroke. The student will also learn water safety skills.



PHYSICAL EDUCATION 110**Lap Swimming For Fitness****1 UNIT - (RPT 3) (UC:CSU)***Laboratory 2 hours.**Prerequisite: Physical Education 102*

For experienced swimmers who want to improve their speed, strength, and endurance. Students should be able to swim 50 yards without stopping in deep water using the freestyle stroke and rotary breathing. Class sessions consist of instructor directed, organized swimming workouts. At the first pool session, an assessment of swimming ability will be conducted to ensure minimum skills for participation.

PHYSICAL EDUCATION 122**Water Activities - Aqua Exercise****1 UNIT - (RPT 3) (UC:CSU)***Laboratory 2 hours.*

Instruction includes progressive skills attainment. Beginning, intermediate, and advanced level offered.

**PHYSICAL EDUCATION 128
ROCK CLIMBING FOR FITNESS****1 UNIT - (RPT 3) (UC:CSU)***Laboratory 2 hours.*

This course was designed to provide exercise and fitness training for the beginning student who wants to learn more about equipment needs, new climbing areas, restrictions, and techniques for safe climbing. This class is created to accommodate first time climbers as well as those with some indoor rock climbing experience. The class is designed to be fun and challenging with the main emphasis on movement and self-esteem building. Students will develop muscular strength and endurance and improve their cardiovascular system.

PHYSICAL EDUCATION 170**Walking for Fitness****1 UNIT - (RPT 3) (UC:CSU)***Laboratory 2 hours.*

This course focuses on achieving cardiovascular fitness and a healthy lifestyle through walking. Course topics include posture, gait, walking styles, strength and flexibility, proper clothing, nutrition and nutritional aides, creating a walking program and fitness assessments.

PHYSICAL EDUCATION 185*see end of this section***PHYSICAL EDUCATION 203-299****Individual and Dual Activities****1 UNIT - (RPT 3) (UC:CSU)***Activity 2 hours.*

In each sport or activity special attention is paid to techniques, strategy, etiquette, terminology, history, and rules.

PHYSICAL EDUCATION 203**Badminton Skills****1 UNIT - (RPT 3) (UC:CSU)***Laboratory 2 hours.*

Students develop the fundamental skills of badminton including basic strokes, rules of the game, singles, doubles and strategy.

PHYSICAL EDUCATION 212**Tennis Skills****1 UNIT - (RPT 3) (UC:CSU)***Laboratory 2 hours.***PHYSICAL EDUCATION 216 ARCHIVED****Paddle Tennis Skills****1 UNIT - (RPT 3) (UC:CSU)****PHYSICAL EDUCATION 219****Table Tennis Skills****1 UNIT - (RPT 3) (UC:CSU)***Laboratory 2 hours.***PHYSICAL EDUCATION 225****Individual & Dual Activities - Yoga Skills****1 UNIT - (RPT 3) (UC:CSU)***Laboratory 2 hours.***PHYSICAL EDUCATION 228****Individual and Dual Activities Body Conditioning****1 UNIT - (RPT 3) (UC:CSU)***Laboratory 2 hours.*

In each sport or activity, special attention is paid to techniques, strategy, etiquette, terminology, history, and rules. Individual courses may be taken four times.

PHYSICAL EDUCATION 229**Individual and Dual Activities: Body Dynamics****1 UNIT - (RPT 3) (UC:CSU)***Laboratory 2 hours.*

In each sport or activity, special attention is paid to techniques, strategy, etiquette, terminology, history, and rules. Individual courses may be taken four times.

PHYSICAL EDUCATION 230**Weight Training****1 UNIT - (RPT 3) (UC:CSU)***Lecture .5 hour. Laboratory 1.5 hours.*

Students develop flexibility, muscular strength, muscular endurance, and cardiovascular endurance. Students learn the proper techniques to utilize in their personal fitness later in life, to achieve a healthier lifestyle.

PHYSICAL EDUCATION 238**Self-Defense Skills****1 UNIT - (RPT 3) (UC:CSU)***Lecture 1 hour. Laboratory 1 hour.*

In each sport or activity, special attention is paid to techniques, strategy, etiquette, terminology, history, and rules. Individual courses may be taken four times.

PHYSICAL EDUCATION 241**Judo Skills****1 UNIT - (RPT 3) (UC:CSU)***Lecture .5 hour. Laboratory 1.5 hours.*

In each sport or activity, special attention is paid to techniques, strategy, etiquette, terminology, history, and rules. Individual courses may be taken four times.

PHYSICAL EDUCATION 247 ARCHIVED**Gymnastics Skills****1 UNIT - (RPT 3) (UC:CSU)****PHYSICAL EDUCATION 259****Golf Skills****1 UNIT - (RPT 3) (UC:CSU)***Laboratory 3 hours.*

Students learn the fundamental techniques and skills, rules, terminology and etiquette of golf.

PHYSICAL EDUCATION 262**Track and Field Skills****1 UNIT - (RPT 3) (UC:CSU)***Laboratory 2 hours.*

Sports activity paying special attention to techniques, strategy, etiquette, history and rules. Individual courses may be taken four times.

PHYSICAL EDUCATION 299
Stress Management Techniques Through
Movement and Dance

1 UNIT - (RPT 3) (UC:CSU)

Laboratory 2 hours.

This course helps us identify our stressors and introduces techniques such as breathing, yoga, relaxation exercises, movement, and dance as a means of coping with the stress in our lives.

PHYSICAL EDUCATION 300-399
Team Sports

1 UNIT - (RPT 3) (UC:CSU)

Activity 2 hours.

In each sport or activity, special attention is paid to techniques, strategy, etiquette, terminology, history, and rules.

PHYSICAL EDUCATION 301
Baseball Skills

1 UNIT - (RPT 3) (UC:CSU)

Laboratory 2 hours.

PHYSICAL EDUCATION 304
Basketball Skills

1 UNIT - (RPT 3) (UC:CSU)

Laboratory 2 hours.

Instruction and practice in the fundamental skills of basketball and in offensive and defensive game strategies. Co-educational participation in drills and competition.

PHYSICAL EDUCATION 313
Team Sports - Soccer Skills

1 UNIT - (RPT 3) (UC:CSU)

Laboratory 2 hours.

PHYSICAL EDUCATION 322
Volleyball Skills

1 UNIT - (RPT 3) (UC:CSU)

Laboratory 2 hours.

Students learn volleyball skills and techniques. Skills learned are passing, setting, serving, hitting and blocking. The students also learn strategy used for games and rules of the sport.

PHYSICAL EDUCATION 328
Softball Skills

1 UNIT - (RPT 3) (UC:CSU)

Laboratory 2 hours.

PHYSICAL EDUCATION 401 ARCHIVED

International Folk Dance Skills

1 UNIT - (RPT 3) (UC:CSU)

Laboratory 2 hours.

PHYSICAL EDUCATION 446 ARCHIVED

Tap Dance

1 UNIT - (RPT 3) (UC:CSU)

PHYSICAL EDUCATION 459 ARCHIVED

Flamenco and Spanish Dancing

1 UNIT - (RPT 3) (UC:CSU)

PHYSICAL EDUCATION 468 ARCHIVED

Jazz Dance Combinations

1 UNIT - (RPT 3) (UC:CSU)

PHYSICAL EDUCATION 469 ARCHIVED

Conditioning for Dance

1 UNIT - (RPT 3) (UC:CSU)

PHYSICAL EDUCATION 500-599
Intercollegiate Athletics Sports

2 UNITS - (RPT 1) (UC:CSU)

Activity 10 hours or more in the sports in season for the following courses.

PHYSICAL EDUCATION 500
Basketball Theory

3 UNITS - (RPT 1) - (CSU)

Lecture 3 hours.

Basketball theory and application consisting of individual and team drills coupled with strategy and tactics of offensive and defensive play are presented.

PHYSICAL EDUCATION 502
Intercollegiate Sports – Badminton

2 UNITS - (RPT 1) (UC:CSU)

Laboratory 10 hours.

PHYSICAL EDUCATION 503
Baseball

2 UNITS - (RPT 1) (UC:CSU)

Laboratory 10 hours.

PHYSICAL EDUCATION 504
Basketball

2 UNITS - (RPT 1) (UC:CSU)

Lecture 2 hours. Laboratory 8 hours.

Prerequisite: Tryouts.

Advanced basketball designed for people who will participate in intercollegiate basketball. Includes numerous field trips, film study and skill development.

PHYSICAL EDUCATION 506
Intercollegiate Sports – Cross Country

2 UNITS - (RPT 1) (UC:CSU)

Laboratory 10.50 hours.

This course offers advanced instruction in the fundamental skills and techniques of cross country running for the practical application in intercollegiate competition.

PHYSICAL EDUCATION 509
Intercollegiate Sports-Golf

2 UNITS - (RPT 1) (UC:CSU)

Lecture 1 hour. Laboratory 9 hours.

This course offers advanced instruction in the fundamental skills and techniques of golf and an opportunity for practical application in intercollegiate competition.

PHYSICAL EDUCATION 511 ARCHIVED

Soccer

2 UNITS - (RPT 1) (UC:CSU)

Prerequisite: Tryouts.

PHYSICAL EDUCATION 514
Intercollegiate Sports-Tennis

2 UNITS - (RPT 3) (UC:CSU)

Lecture 1 hour. Laboratory 9 hours.

Students with intermediate and advanced tennis skills need and opportunity to participate in higher levels of singles and doubles competition.

PHYSICAL EDUCATION 515
Track and Field

2 UNITS - (RPT 3) (UC:CSU)

Laboratory 10 hours.

This course offers men and women students with advanced track and field skills and opportunity to participate in intercollegiate track and field.

PHYSICAL EDUCATION 516**Volleyball****2 UNITS - (RPT 1) (UC:CSU)***Laboratory 10 hours.*

Students with intermediate and advanced volleyball skills are given the opportunity to compete at the intercollegiate level.

PHYSICAL EDUCATION 552**Athletic Pre-season Conditioning****1 UNIT - (RPT 3) (UC:CSU)***Laboratory 3 hours.*

Students learn and practice conditioning exercises in preparation for intercollegiate competition in basketball, badminton, and/or volleyball.

PHYSICAL EDUCATION 630-810**Fitness****0.5-2 UNITS - (RPT VARIES) (UC:CSU)***Activity hours vary.***PHYSICAL EDUCATION 630****Aerobic Super Circuit****LABORATORY****1 UNIT - (RPT 3) (UC:CSU)***Laboratory 2 hours.*

Using fundamentals of exercise physiology, each student will assess his/her level of physical fitness, develop a fitness profile, and design and implement a personalized exercise program.

PHYSICAL EDUCATION 635**Circuit Training****0.5 UNIT - (RPT 3) (UC:CSU)***Laboratory 1 hour.*

This type of training focuses on building cardiovascular endurance and total body strength. Students perform various kinds of cardiovascular and strength exercises, in timed intervals. Different types of equipment are used such as stationary bicycles, weight machines, hand weights, and stretch bands.

PHYSICAL EDUCATION 637 ARCHIVED

Spin Cycling Aerobic

0.5 UNIT - (RPT 3) (UC:CSU)

PHYSICAL EDUCATION 639**Hatha Yoga****1 UNIT - (RPT 3) (UC:CSU)***Laboratory 10 hours.**Advisory: Physical Education 225 Yoga Skills.*

This class provides a more in-depth exposure and experience with Hatha Yoga. Special attention is paid to Hatha Yoga styles, terminology, history, and developing personal skill level. Individual course may be taken four times.

PHYSICAL EDUCATION 640**Beginning Lifelong Fitness****Laboratory****1 UNIT - (RPT 3) (UC:CSU)***Laboratory 3 hours.*

Students develop flexibility, muscular strength, muscular endurance, cardiovascular endurance, and body composition. Students learn how to achieve a healthy lifestyle and proper fitness balance.

PHYSICAL EDUCATION 641 ARCHIVED

Introduction to Laboratory Techniques in Adapted Physical Education

2 UNITS - (RPT 3) (UC:CSU)

PHYSICAL EDUCATION 642**Adapted Fitness****1 UNIT - (RPT 3)***Laboratory 3 hours.*

Course is designed to meet the needs of students with disabilities who require restricted or modified activities. Individualized exercise programs will be performed by students with instruction covering the basic elements of physical fitness and training principles.

PHYSICAL EDUCATION 643 ARCHIVED

Adapted Strength Training

1 Unit - (UC:CSU)

PHYSICAL EDUCATION 644 ARCHIVED

Adapted Swimming and Hydroexercise

1 UNIT - (RPT 3)

PHYSICAL EDUCATION 645 ARCHIVED

Adapted Aerobics

1 UNIT - (RPT 3)

PHYSICAL EDUCATION 646 ARCHIVED

Adapted Cardiovascular Fitness

1 Unit - (RPT 3) (UC:CSU)

PHYSICAL EDUCATION 647 ARCHIVED

Adapted Aqua Aerobics

1 Unit - (RPT 3) (UC:CSU)

PHYSICAL EDUCATION 648 ARCHIVED

Adapted Exercise for Back Disorders

1 Unit - (RPT 3) (UC:CSU)

PHYSICAL EDUCATION 649 ARCHIVED

Adapted Sports and Games

1 Unit - (RPT 3) (UC:CSU)

PHYSICAL EDUCATION 712**Introduction to Physical Education****3 UNITS - (RPT 3) (UC:CSU)***Lecture 3 hours.*

A study of the physical, mental, emotional, and social effects or organized physical education programs. Special emphasis is placed on the history, philosophy, professional qualifications, career opportunities, and current trends and curriculum development.

PHYSICAL EDUCATION 713 ARCHIVED**Introduction to Coaching Athletics****3 UNITS - (RPT 3) (UC:CSU)****PHYSICAL EDUCATION 714 ARCHIVED****Coaching Team Sports****3 UNITS - (RPT 3) (UC:CSU)****PHYSICAL EDUCATION 715 ARCHIVED****Coaching Individual Sports****3 UNITS - (UC:CSU)**

PHYSICAL EDUCATION 716 ARCHIVED
Games & Rhythms/Elementary School I
3 UNITS - (CSU)

PHYSICAL EDUCATION 720 ARCHIVED
Theory and Practice of Olympic Sport Judo
3 UNITS - (RPT 3) (UC:CSU)

PHYSICAL EDUCATION THEORY CLASSES

Physical Education Major

These classes do not meet credit for Physical Education activity. Required for Physical Education and Recreation majors and minors.

PHYSICAL EDUCATION 810 ARCHIVED

PE Folk Dance

2 UNITS - (UC:CSU)

Lecture 1 hour. Laboratory 2 hours.

This course offers an in depth study of folk dance, its history, characteristics, and music for students interested in teaching.

PHYSICAL EDUCATION 185

Directed Study — 1 UNIT (CSU)

PHYSICAL EDUCATION 285

Directed Study — 2 UNITS (CSU)

PHYSICAL EDUCATION 385

Directed Study — 3 UNITS (CSU)

Conference 1 hour per unit.

Physical Education students pursue on their own an in-depth study of a subject of special interest in the field of physical education. Guidance and consultation with the instructor on a weekly basis, plus independent work is required. Refer to the "Directed Study" section of this catalog for additional information.

Credit Limit: A maximum of 3 units in Directed Study may be taken for credit.

PHYSICAL SCIENCE

UC Limit: no credit allowed if taken after a college course in Astronomy, Chemistry, Geology or Physics.

PHYSICAL SCIENCE 1

Physical Science

3 UNITS - (UC:CSU)

Lecture 3 hours.

Advisory: English 28 and 67 or equivalent or concurrent enrollment.

Open to all students.

An integrated course for non-science majors developing fundamental concepts of Physics and Chemistry. Topics include principles of motion and energy (Physics) and structure and properties of matter (Chemistry).

PHYSICAL SCIENCE 13

Energy and Power

3 UNITS - (UC:CSU)

Lecture 3 hours.

Prerequisites: Math 115 or Math Placement Test score

The student learns about the environmental impact of current energy sources, their longevity, and strategies for a sustainable future. Important concepts related to energy

such as work, heat, power, conversion and efficiency are covered and applied to important systems that produce or consume energy. National and global consumption patterns and the consequences of reliance on dwindling fossil fuels are considered. This course is important for those interested in understanding green technology or sustainable policy making.

PHYSICAL SCIENCE 14

Physical Science Laboratory

1 UNIT - (UC:CSU)

Laboratory 3 hours.

Co-requisite: Physical Science 1. Advisory: English 21

This course provides the liberal arts student with laboratory experience which supplements the instruction given in Physical Science. Taken with or after Physical Science 1, it completes the transfer and graduation requirement for a Natural Science course with laboratory.

PHYSICS

PHYSICS 6

General Physics I

4 UNITS - (UC:CSU)

Lecture 3 hours. Laboratory 3 hours.

Advisory: English 28 and 67.

This course is designed for majors in Health and Life Sciences, Architecture, and all those needing a one year course in college physics requiring trigonometry but not calculus (see also Physics 21). The principal topics are mechanics, heat and sound.

PHYSICS 7

General Physics II

4 UNITS - (UC:CSU)

Lecture 3 hours. Laboratory 3 hours.

Prerequisite: Physics 6 with a satisfactory grade or equivalent.

Advisory: 28

This course is designed for majors in Health and Life Sciences, Architecture, and all those needing a one-year course in college physics requiring trigonometry but not calculus. This course examines the later developments of physics leading through electricity and magnetism to optics, relativity and quantum theory, atomic and nuclear physics.

PHYSICS 11

Introductory Physics

4 UNITS - (UC:CSU)

Lecture 3 hours. Laboratory 3 hours.

Prerequisite: Mathematics 115 with a satisfactory grade or equivalent. Advisory: English 28 and 67 and Mathematics 121.

Credit allowed for only one of Physics 11 or 12.

This general introductory course with laboratory serves as the prerequisite for Physics 101, 6, 21, and for the health career programs. It is aimed at developing physical intuition, problem solving techniques and laboratory procedures. It is not open to students who have had a college course in physics. Those needing only one semester of laboratory science should consider enrolling in Physics 12..

PHYSICS 12
Physics Fundamentals
3 UNITS - (UC:CSU)

Lecture 3 hours.

Open to all students.

Advisory: English 28 and 67 or equivalent. Credit allowed for only one of Physics 12 and 11.

A survey of the major insights of physics. No mathematical preparation is needed. If a student wishes to transfer this as a lab science course, the student must also complete Physics 14.

PHYSICS 14
Physics 14 Laboratory
1 UNIT - (UC:CSU)

Laboratory 3 hours.

Co-requisite: Physics 12. Advisory: English 21

This introductory laboratory course in general physics provides the liberal arts student with laboratory experience which supplements the instruction given in Physics 12. Taken with or after Physics 12, it completes the units requirement for a Natural Science course with laboratory.

PHYSICS 21
General Physics I with Calculus
4 UNITS - (UC:CSU)

Lecture 3 hours. Laboratory 3 hours.

Prerequisite: Physics 11 with a satisfactory. Co-requisite: Mathematics 261.

Advisory: English 21 or equivalent.

Physics 21 is the first of a two-semester, calculus-based, sequence of general physics courses. (Physics 22 completes the sequence.) This sequence is recommended and designed for Pre-medical students, Life Science students and other students that require a two-semester, calculus based, sequence of physics courses. Topics covered in Physics 21 include mechanics, waves and fluids, with an emphasis on applications to the life sciences.

PHYSICS 22
General Physics II with Calculus
4 UNITS - (UC:CSU)

Prerequisites: Physics 21 with a satisfactory grade or equivalent. Co-requisite: Mathematics 262.

Lecture 3 hours. Laboratory 3 hours.

Physics 22 is the second of a two-semester, calculus-based, sequence of general physics courses. This sequence is recommended and designed for Pre-medical students, Life Science students and other students that require a two-semester, calculus based, sequence of physics courses. Topics covered in Physics 22 include thermodynamics, electricity and magnetism, optics, and atomic and nuclear physics. There will be an emphasis on applications to the life sciences.

PHYSICS 101
Physics for Engineers and Scientists I
5 UNITS - (UC:CSU)

Lecture 3 hours. Laboratory 6 hours.

Prerequisite: Physics 11 with a satisfactory grade or high school physics. Co-requisite: Mathematics 261 or appropriate score on Math Placement test.

Considers the fundamental principles and applications of Newton's Laws in classical mechanics, including motion in one and two dimensions, gravitation, rotation, energy, momentum, periodic motion, and fluid mechanics at the beginning calculus level of mathematical sophistication. The laboratory includes both quantitative and qualitative experiments that permit students to verify, illustrate, and deduce various laws of physics.

PHYSICS 102
Physics for Engineers and Scientists II
5 UNITS - (UC:CSU)

Lecture 3 hours. Laboratory 6 hours.

Prerequisite: Physics 101 with a satisfactory grade or equivalent.

Co-requisite: Concurrent enrollment in Mathematics 262, unless taken previously.

Physics 102 continues the study of physics begun in PHYSICS 101. In PHYSICS 102 students learn the topics of introductory thermodynamics (temperature, heat, heat engines, entropy and other topics), and electricity and magnetism (electric forces, electric fields, potential, magnetism, magnetic forces and fields, capacitance, resistance, inductance, DC and AC circuits and other topics). The laboratory includes both quantitative and qualitative experiments which permit students to verify, illustrate and deduce the laws of physics related to the topics discussed.

PHYSICS 103
Physics for Engineers and Scientists III
5 UNITS - (UC:CSU)

Lecture 3 hours. Laboratory 6 hours.

Prerequisite: Physics 102 with a satisfactory grade or equivalent.

Co-requisite: Concurrent enrollment in Mathematics 263, unless taken previously.

Physics 103 concludes the introductory sequence begun in PHYSICS 101 and 102. In PHYSICS 103 students learn the topics of mechanical waves, electromagnetic waves, light and optics, relativity, introductory quantum mechanics, atomic and nuclear physics. Topics in molecular and condensed matter as well as particle physics may also be included. The laboratory includes both quantitative and qualitative experiments which enable students to verify, illustrate, and deduce some of the laws of physics that apply to the topics covered.

PHYSICS 185 DIRECTED STUDY —
1 UNIT (CSU)

PHYSICS 285 DIRECTED STUDY —
2 UNITS (CSU)

PHYSICS 385 DIRECTED STUDY —
3 UNITS (CSU)

Prerequisite: Signature of Instructor and Science and Mathematics classes appropriate to the research to be undertaken.

Lecture 1 hour per unit.

Allow students to pursue Directed Study on a contract basis under the direction of a supervising instructor. Refer to the "Directed Study" section of this catalog for additional information.

Credit Limit: A maximum of 3 units in Directed Study may be taken for credit.

ARCHIVED

PHYSICS 1 Mechanics of Solids - 4 UNITS (UC:CSU)

PHYSICS 2 Mechanics Of Flies, Heat, and Sound - 4 UNITS (UC:CSU)

PHYSICS 3 Electricity and Magnetism - 4 UNITS (UC:CSU)

PHYSICS 4 Optics and Modern Physics - 4 UNITS (UC:CSU)

PHYSIOLOGY

PHYSIOLOGY 1 Introduction to Human Physiology 4 UNITS - (UC:CSU)

Lecture 3 hours. Laboratory 3 hours.

Prerequisite: Anatomy 1 with a satisfactory grade or equivalent.

Advisory: English 21 or equivalent.

Presents general principles of physiology with special emphasis upon the human body.

POLITICAL SCIENCE

POLITICAL SCIENCE 1 The Government of the United States 3 UNITS - (UC:CSU)

Lecture 3 hours.

Note: Meets Associate in Arts degree requirements in U. S. History. U.S. Constitution, California State and local government.

Students study the U.S. Constitution and the major principles, institutions and policies of the American Federal system. Meets Associate in Arts degree requirements in U. S. History and U.S. Constitution.

POLITICAL SCIENCE 2 Modern World Governments 3 UNITS - (UC:CSU)

Lecture 3 hours.

Advisory: English 28 and 67 or equivalent.

Modern World Governments is a comparative study of the constitutional institutions and political problems of selected governments abroad.

POLITICAL SCIENCE 7 Contemporary World Affairs 3 UNITS - (UC:CSU)

Lecture 3 hours.

Advisory: Political Science 1 or equivalent.

Students learn the major aspects and important issues of international relations and global politics, including but not limited to the study of war and conflict, international organizations and actors, and development and globalization.

PSYCHOLOGY

PSYCHOLOGY 1 General Psychology I 3 UNITS - (UC:CSU)

Lecture 3 hours.

Students learn the psychological principles behind behaviors such as learning, motivation, intelligence, feelings and emotions, personality, abnormal behavior and methods of adjustment. Different psychological perspectives such as psychoanalysis, neuroscience, cognitive, behaviorism and humanism will be emphasized.

PSYCHOLOGY 2 General Psychology II 3 UNITS - (UC:CSU)

Lecture 3 hours.

This course explains psychological behavior on the basis of events taking place in the brain, nervous systems and endocrine glands. The biological events which underlie these systems are explained and identified with regard to their effect on moods, sexuality, motivation, sleep, perception, and learning.

PSYCHOLOGY 3 Personality and Social Development 3 UNITS - (CSU)

Lecture 3 hours.

Prerequisite: Psychology 1 with a satisfactory grade or equivalent.

This course focuses on self awareness and personality development. Topics considered include love, work, loneliness, death and loss, intimate relationships, sex roles and sexuality, and values in life.

PSYCHOLOGY 13 Social Psychology 3 UNITS - (UC:CSU)

Lecture 3 hours.

Prerequisite: Psychology 1 with a satisfactory grade or equivalent.

A study of how we are influenced by our society in the areas of persuasion, propaganda and brain washing, obedience and conformity, aggression and prejudice, sexism and interpersonal relationships.

PSYCHOLOGY 14 Abnormal Psychology 3 UNITS - (UC:CSU)

Lecture 3 hours.

Prerequisite: Psychology 1 with a satisfactory grade or equivalent.

An overview of abnormal behavior from the perspective of contemporary medical, psychosocial, and socio-cultural approaches. Abnormal disorders are described, and their major causes and treatment are reviewed.

PSYCHOLOGY 18 ARCHIVED Psychology of Women's and Men's Changing Roles 3 UNITS - (UC:CSU)

PSYCHOLOGY 24 ARCHIVED Scholastic and Personal Development 3 UNITS - NDC

PSYCHOLOGY 27 Online and Software Resources for Human Services 1 UNIT

Lecture 1 hour.

This course provides Human Services majors with a basic introduction to pertinent computer resources currently being utilized by human services professionals. Hands-on training will allow students to become familiar with software and online resources commonly being used.

PSYCHOLOGY 38 ARCHIVED Forensic Psychology 2 UNITS

PSYCHOLOGY 41
Life Span Psychology: From
Infancy to Old Age
3 UNITS - (UC:CSU)

Lecture 3 hours.

Prerequisite: Psychology 1 with a satisfactory grade.

This course familiarizes the student with physical, cognitive and social growth and change affecting individuals during their many life stages. Periods examined include prenatal, infancy, childhood, adolescence, and old age.

PSYCHOLOGY 43
Principles of Group Dynamics I
3 UNITS - (CSU)

Lecture 3 hours.

This is an introduction to the dynamics of group interactions with an emphasis upon the individual's first hand experience as the group studies itself. Students are evaluated on a credit/no credit basis.

PSYCHOLOGY 44
Principles of Group Dynamics II
3 UNITS - (CSU)

Lecture 3 hours.

Prerequisite: Psychology 43 with a satisfactory grade or equivalent.

This course covers the role of group processes in changing behavior, as well as the principle modes of counseling and therapy. Also covered are the principles of verbal and nonverbal communication, modes of learning, key concepts that enhance learning and significant communication.

PSYCHOLOGY 45
Issues in Human Service Careers
3 UNITS - (CSU)

Lecture 3 hours.

Prerequisite: Psychology 44 and Psychology 81 with satisfactory grades or equivalent.

This is a course in how to survive in the real world of work in Human Services. It will integrate the psychological theory learned in previous classes with practice. The course covers specialized areas of psychology such as crisis intervention, psychopharmacology, counseling ethics, and interviewing. Included are techniques for agency survival such as job interviewing, report writing and resource referral.

PSYCHOLOGY 52
Psychological Aspects of Human Sexuality
3 UNITS - (UC:CSU)

Lecture 3 hours.

This course explores psychological aspects of human sexuality. It emphasizes the effect of sexual development and functioning, on self concept and sexual identity. Topics included are: history of sexuality; myths and fallacies; physiology of sexuality; sexually transmitted diseases; paraphilias and sexual orientation.

PSYCHOLOGY 60
Stress Management
3 UNITS - (CSU)

Lecture 3 hours.

This course examines methods of identifying and managing environmental, organizational, social and internal stress in an effort to promote more effective coping on the part of the individual in occupational, interpersonal and everyday life situations.

PSYCHOLOGY 63
Alcohol/Drug Studies:
Prevention and Education
3 UNITS - (CSU)

Lecture 3 hours.

This course introduces students to prevention and education of alcohol, drug problems and HIV/AIDS among various populations. The techniques of prevention and education in the community, family, school, worksite, and healthcare facilities will be emphasized.

PSYCHOLOGY 64
Introduction to Alcohol and Drug Abuse and
Physiological Effects
3 UNITS - (CSU)

Lecture 3 hours.

This course is an introduction to the: physiology and psychopharmacology of drugs and alcohol, theories of addiction, historical overview of treatment, drug classification, social policy and drug abuse, and the issues of relapse, rehabilitation and recovery.

PSYCHOLOGY 65
Chemical Dependency, Intervention, Treatment
and Recovery
3 UNITS - (CSU)

Lecture 3 hours.

This course introduces the student to the processes of treatment and recovery of alcohol and drug abuse among various populations. An overview of the causes, treatment, models, and recovery, relapse, rehabilitation, and aftercare is emphasized.

PSYCHOLOGY 66
Introduction to Critical Thinking
3 UNITS - (CSU)

Lecture 3 hours.

Advisory: Eligibility for English 28 and 67.

Students apply the theories and research evidence in cognitive psychology to enhance the ability to effectively solve problems, make decisions and think creatively. Practice with a variety of problems and simulations take place to ensure these critical thinking skills.

PSYCHOLOGY 67
Counseling Techniques for Chemically Addicted
3 UNITS - (CSU)

Lecture 3 hours.

This course will focus on the environment of chemical dependency counseling and the issues of the paraprofessional in alcohol and drug abuse treatment facilities. Case management in a multi-discipline team will be emphasized. All aspects of modern treatment techniques will be covered in class.

PSYCHOLOGY 68
Biopsychology of Chemical
Dependency: Drugs, behavior, and health
3 UNITS - (CSU)

Lecture 3 hours.

This course offers comprehensive instruction on the pharmacological and behavioral effects of all major categories of both legal and illegal psychoactive substances, including an overview of contemporary and historical drug regulation and abuse, and a detailed review of the nervous system.

PSYCHOLOGY 72 ARCHIVED
 Introduction to Psychology Journal Research
 3 UNITS - (CSU)

PSYCHOLOGY 81**Field Work I
3 UNITS – (RPT 1) (CSU)**

*Co-requisite: Psychology 1 and Psychology 43.
Lecture 1 hour. Laboratory 5 hours.*

This course is designed to orient the student to the field of Human Services. The primary emphasis is on observations of the application of interpersonal relationship skills in community settings. This class is intended for students new to Human Services fieldwork. Basic counseling and communication skills will be taught.

PSYCHOLOGY 82**Field Work II
3 UNITS - (CSU)**

Lecture 1 hour. Laboratory 6 hours.

Prerequisite: Psychology 81 with a satisfactory grade or equivalent.

Students build on the skills they learned in Field Work I by participating, under supervision, at various facilities in the community that offer Human Services.

PSYCHOLOGY 83**FIELD WORK III
3 UNITS - (CSU)**

Lecture 1 hour. Laboratory 6 hours.

Prerequisite: Psychology 82 with a satisfactory grade or equivalent.

Students learn more specialized skills in Human Services. This class is intended for the advanced student of the generalist option of Human Services.

PSYCHOLOGY 84**FIELDWORK I – DRUG/ALCOHOL
3 UNITS**

Lecture 1.5 hours. Laboratory 5.5 hours.

Co-requisite: Psychology 1 and Psychology 43.

This course is designed to orient the student to the field of Human Services, Drug/Alcohol Studies. The primary emphasis is on the observations of the application of interpersonal relationship skills in drug/alcohol treatment and community settings. This class is intended for students new to Human Services field work. Basic counseling and communication skills will be taught.

PSYCHOLOGY 85**FIELD WORK II: DRUG/ALCOHOL
3 UNITS - (CSU)**

Lecture 1.5 hours. Laboratory 6 hours.

Prerequisite: Psychology 84 with a satisfactory grade or equivalent.

The student receives more specialized participation in Human Services, Drug/Alcohol Studies. The primary emphasis is on the observations of the application of interpersonal relationship skills in drug/alcohol treatment and community settings. This class is intended for students with some experience of the Human Services field work. Basic counseling and communication skills will be taught.

PSYCHOLOGY 86**FIELD WORK III: DRUG/ALCOHOL
3 UNITS - (CSU)**

Lecture 1.5 hours. Laboratory 5.5 hours.

Prerequisite: Psychology 85 with a satisfactory grade or equivalent.

This course is designed to orient the student to the field of Human Services, Drug/Alcohol Studies. The primary emphasis is on the observations of the application of interpersonal relationship skills in drug/alcohol treatment and community settings. This class is intended for students new to Human Services field work. Basic counseling and communication skills will be taught.

PSYCHOLOGY 185**DIRECTED STUDY — 1 UNIT (CSU)****PSYCHOLOGY 285 ARCHIVED****DIRECTED STUDY — 2 UNITS (CSU)****PSYCHOLOGY 385****DIRECTED STUDY — 3 UNITS (CSU)**

Prerequisite: Psychology 1 with a satisfactory grade plus one additional course in Psychology and signature of instructor.

Lecture 1 hour per unit.

Allows students to pursue Directed Study on a contract basis under the direction of a supervising instructor. Refer to the “Directed Study” section of this catalog for additional information.

Credit Limit: A maximum of 3 units in Directed Study may be taken for credit.

**RADIOLOGIC
TECHNOLOGY**

NOTE: Not every class is offered each semester. Refer to the current class schedule for current class offerings.

PREREQUISITES: Specified prerequisites must be completed with a satisfactory grade or equivalent.

RADIOLOGIC TECHNOLOGY 100**Introduction to Radiologic
Technology****1 UNIT - (A)**

Lecture 1 hour.

(Open to all students) An introduction course for students interested in a career in Radiologic Technology. The role of the Radiographer and career advancement are emphasized. Students interested in taking advanced classes in Radiologic Technology must successfully complete RT 100 and RT 101. Clinical education centers will be visited.

RADIOLOGIC TECHNOLOGY 101**Medical Terminology for Radiologic Technology****1 UNIT - (A)**

Lecture 1 hour.

Advisory: English 28 and 67.

Open to all students.

This course is designed to introduce the student to the medical terminology used in the field of Radiologic Technology.

RADIOLOGIC TECHNOLOGY 102**Image Recording and Film Processing****3 UNITS - (A)**

Lecture 2 hours. Laboratory 3 hours.

Prerequisite: Completion of English 28, RT 100 and RT 101.

Advisories: Math 115 and English 67.

Students gain the knowledge to understand x-ray production, and film processing. Students are also introduced to radiation protection. Laboratory experience is included.

RADIOLOGIC TECHNOLOGY 103**Radiographic Anatomy and
Positioning - Skeletal System****4 UNITS - (A)**

Lecture 3 hours. Laboratory 2 hours.

Prerequisite: Radiologic Technology 102 with a satisfactory grade. Admission to the Radiologic Technology Program.

Students learn radiographic anatomy, positioning and selected pathology of the musculoskeletal system. Laboratory experience is included.

RADIOLOGIC TECHNOLOGY 104
Radiographic Anatomy and Positioning - Cranium and Visceral Organs
4 UNITS - (A)

Lecture 3 hours. Laboratory 2 hours.
 Prerequisite: Radiologic Technology 101 and 103 with a satisfactory grade.

Students learn radiographic anatomy, positioning and selected pathology of the visceral organs and cranium. Laboratory experience is included.

RADIOLOGIC TECHNOLOGY 105
Fundamentals of X-ray Physics
3 UNITS - (A)

Lecture 3 hours.
 Prerequisite: Radiologic Technology 100, 101, and 102.
 Students learn the basic physical principles of x-ray generation. Emphasis is placed on the electrical circuitry of radiographic equipment. Interactions between x-ray radiation and matter is explained and students learn the principles that govern radiographic technique and quality.

RADIOLOGIC TECHNOLOGY 106
Digital Radiography
3 UNITS - (A)

Lecture 3 hours.
 Prerequisite: Radiologic Technology 105 and 110 with satisfactory grade.

Students learn the factors that affect radiographic exposure. Laboratory experience is provided. Computer applications in diagnostic medical imaging are also introduced.

RADIOLOGIC TECHNOLOGY 107
Patient Care and Management
3 UNITS - (A)

Lecture 3 hours.
 Prerequisite: Radiologic Technology 100, 101, and 102.
 Admission to the Radiologic Technology Program.

Students learn the principles of patient care management for radiographers. Routine and emergency care procedures are discussed. The role of the radiographer in patient education will also be explained. Laboratory experience is included.

RADIOLOGIC TECHNOLOGY 110
Radiographic Mathematics
2 UNITS - (A)

Laboratory 2 hours.
 Prerequisite: Radiologic Technology 100, 101, and 102 with satisfactory grade.

Students learn the principles of mathematics encountered in Radiologic Technology. This course complements Radiologic Technology 105 and 106.

RADIOLOGIC TECHNOLOGY 140
Radiation Protection and Biology
3 UNITS - (A)

Lecture 3 hours.
 Prerequisite: Radiologic Technology 102 and 107 with satisfactory grade.

Students learn potential hazards associated with the use of and the protective measures necessary to reduce radiation exposure to patients and personnel. Students are taught techniques to prepare for the State and national certificate examinations.

RADIOLOGIC TECHNOLOGY 160
Introduction to Clinical Education
4 UNITS - (A)

Lecture 4 hours.
 Prerequisite: Radiologic Technology 101 and 103 with a satisfactory grade or equivalent.

Students begin the clinical education phase of the program. The student is assigned 16 hours per week in a clinical education center.

RADIOLOGIC TECHNOLOGY 180
Clinical Education in Radiologic Technology
12 UNITS - (RPT 2) (A)

Lecture 12 hours.
 Prerequisite: Radiologic Technology 103, 104, 105, 106, 107, 140, 160. Enrolled in the Radiologic Technology program.

Students perform all duties of a radiographer under the direction of a clinical education instructor. Students are dismissed from the clinical site to return to the campus to attend regular classes in late afternoons and evenings. Students are evaluated on a credit/no credit basis.

RADIOLOGIC TECHNOLOGY 243
Principles and Practices of Fluoroscopy
3 UNITS

Lecture 2 hours. Laboratory 2 hours.
 Prerequisite: Radiologic Technology 106 & 140.

Students differentiate the factors influencing patient fluoroscopic radiation dose. Students also learn how to identify fluoroscopic and anallary equipment. Students are introduced to assembling the components of closed circuit television systems and they conduct the flourescopic examination by applying the regulatory provisions and radiation safety procedures.

REAL ESTATE

REAL ESTATE REAL ESTATE 1
Real Estate Principles
3 UNITS - (CSU)

Lecture 3 hours.
 Open to all students.
 Advisory: English 28 and 67 or equivalent.

This course is required for the California Real Estate examination. A beginning course in real estate fundamentals and principles, including real estate economics, terminology and definitions, real estate law, building and construction, real estate investment, and vocational opportunities in real estate. A practical study of the principles, economic aspects, and laws of real estate, including the information needed to obtain a real estate sales/ brokers license and/or for better management of personal real estate investments. Topics include legal descriptions and estates, encumbrances, agencies, contracts, financing, appraisal, escrow and title, leases, urban economics, taxation, and vocational careers.

REAL ESTATE 3
Real Estate Practice
3 UNITS - (CSU)

Lecture 3 hours

Open to all students.

Advisory: English 28 and 67 or equivalent.

Problems of establishing and conducting a real estate business, including establishing the office, securing listing and prospects, showing properties and closing sales, ethics and professional relationships, rentals and leases, appraising, the California Real Estate Act. Preparation of documents used in real estate transactions, property transfers, and exchanges is included.

REAL ESTATE 5
Legal Aspects of Real Estate I
3 UNITS - (CSU)

Lecture 3 hours.

Open to all students.

Advisory: English 28 and 67 or equivalent.

Legal background for those who plan to take the state examination which is required in order to obtain a broker license (meets optional requirements for sales license), including principles of property ownership and management in their business aspects, with special reference to law of California as it applies to community property, deeds, trust deeds, mortgages, leases, brokerage, mechanic's liens, homesteads, wills, and estates.

REAL ESTATE 6
Legal Aspects of Real Estate II
3 UNITS - (CSU)

Lecture 3 hours.

Students learn advanced issues solving real estate legal matters, including an advanced and in depth study of agency and sub-agency law, civil rights and fair housing laws in real estate practice, and real estate escrow and title insurance laws. The introductory study of wills, trusts, and probate administration as they apply to real estate broker's practice is studied

REAL ESTATE 7
Real Estate Finance I
3 UNITS - (CSU)

Lecture 3 hours

Open to all students.

Advisory: English 28 and 67 or equivalent.

A study of the forms and sources of financing real property, including purchase, construction, refinance, and other creative permanent financing approaches. Also included is an assessment of the procedures for obtaining government-sponsored financing through FHA, DVA, and Cal-Vet. The various loan sources currently being used in the market place will be evaluated including banks, savings and loans, insurance companies, mortgage brokers/bankers, pensions, credit unions, and private parties.

REAL ESTATE 9
Real Estate Appraisal I
3 UNITS - (CSU)

Lecture 3 hours.

Open to all students.

Advisory: English 28 and 67 or equivalent.

The purposes of appraisals, the appraisal process, and the different approaches of valuation. The methods and techniques used to determine the value of various types of properties; The market comparison and cost approaches are emphasized, plus an introduction to investment property valuation by the income approach.

REAL ESTATE 11
Escrow Principles
3 UNITS - (CSU)

Lecture 3 hours.

Advisory: English 28 and 67 or equivalent.

The principles used in handling escrows involving real estate transactions and the transfer of land titles. The basic methods and techniques of escrow holders, as well as and introduction to the types of instruments and forms used by escrow holders from escrow opening through post-closing activities, will be covered. Title insurance, tax issues, prorations, vesting, securing of loans, recording of documents and settlement procedures will be examined. Students will be instructed in the completion of common forms utilized in a basic transaction.

REAL ESTATE 14
Property Management
3 UNITS - (CSU)

Lecture 3 hours.

Open to all students.

Advisory: English 28 and 67 or equivalent.

Intended for individuals planning to become operators or owners of income-producing properties. Topics covered include nature and types of property management, leases and contracts, rent scheduling, selling of space and techniques of renting, tenant selection and supervision, relations with owners and budgets, purchasing and accounts, reporting, ethics, and legal and professional relationships.

REAL ESTATE 18
Real Estate Investments I
3 UNITS - (CSU)

Lecture 3 hours.

Advisory: English 28 and 67 or equivalent.

A study of real estate investment with respect to identifying and understanding the language, basic procedures, financing, and facts essential to ownership, conveyance, environment problems, business organization involvement, and evaluation with other investments. A comparison and assessment of commercial, industrial, and residential projects, including location, feasibility studies, zoning restrictions, financing options, sale and leaseback, and preferential tax benefits.

REAL ESTATE 21
Real Estate Economics
3 UNITS - (CSU)

Lecture 3 hours.

Open to all students.

Advisory: English 28 and 67 or equivalent.

This course covers the fundamentals of economic trends and factors which affect the real estate market. Topics covered include: urban structural relationships, real estate market analysis, supply and demand, economic forecasting, land use theory and problems of sub-division. Also studied is the government's role in the economy and its influence upon the real estate market including the federal reserve system taxation and land use controls including zoning, planning and fair housing legislation.

REAL ESTATE 60
Real Estate Mathematics
3 UNITS - (CSU)

Lecture 3 hours.

Advisory: English 28 and 67 or equivalent.

This course consists of typical real estate mathematics problems which are most common in actual practice, as well as those necessary for other real estate courses and for those found in the California Real Estate Licensing examinations.

RUSSIAN

RUSSIAN 1 Elementary Russian I 5 UNITS – (UC:CSU)

Lecture 5 hours. Laboratory 1 hour.
Advisory: English 28 and 67.

The fundamentals of pronunciation and grammar, practical vocabulary, useful phrases; basic facts on the geography, customs and culture of Russia.

RUSSIAN 2 Elementary Russian II 5 UNITS – (UC:CSU)

Lecture 5 hours. Laboratory 1 hour.
Prerequisite: Russian 1 with a satisfactory grade or equivalent.
Completes elementary Russian I. Emphasis on reading and spoken language.

RUSSIAN 3 Intermediate Russian I 5 UNITS – (UC:CSU)

Lecture 5 hours. Laboratory 1 hour.
Prerequisite: Russian 2 with a satisfactory grade or equivalent.
A review of grammar, additional training in oral and written composition, and reading of more advanced literature.

RUSSIAN 4 Intermediate Russian II 5 UNITS – (UC:CSU)

Lecture 5 hours. Laboratory 1 hour.
Prerequisite: Russian 3 with a satisfactory grade or equivalent.
This course continues the review of grammar and vocabulary build-up. It continues to introduce students to Russian life through the reading of selected Russian authors.

RUSSIAN 8 Conversational Russian 2 UNITS – (UC:CSU) (RPT 3)

Lecture 2 hours.
Prerequisites: Russian 2 with a satisfactory grade or equivalent.
Student develops and practices conversational skills in Russian pertaining to mundane situations and topics a person may encounter when traveling or living among a Russian-speaking community.
UC maximum credit: 4 units

RUSSIAN 10 Russian Civilization 3 UNITS – (UC:CSU)

Lecture 3 hours.
Advisory: English 28 and 67.
Students learn various aspects of Russian Civilization, including historical, social and cultural developments from the early stages to the present, and Russia's contribution to the world.

RUSSIAN 12 Russian Civilization II 3 UNITS – (UC:CSU)

Lecture 3 hours.
Advisory: English 28 and 67.
The students focus on new historical, social and cultural changes that shaped the face of Russia in the 20th – 21st century, and their impact on the world.

RUSSIAN 21 ARCHIVED
Fundamentals of Russian I
3 UNITS – (UC:CSU)
Lecture 3 hours.
Advisory: English 28 and 67.

RUSSIAN 22 ARCHIVED
Fundamentals of Russian II
3 UNITS – (UC:CSU)
Lecture 3 hours.

SOCIOLOGY

SOCIOLOGY 1 Introduction to Sociology 3 UNITS - (UC:CSU)

Lecture 3 hours.
Advisory: English 28 and 67 or equivalent.

This course is designed to acquaint students with the major principles of sociology as they are applied to contemporary social issues. With the use of several theoretical perspectives it examines social structures within American society and other cultures from macro and micro perspectives. There are extensive references to contemporary research findings on social structure, group dynamics, social stratification, and social institutions.

SOCIOLOGY 2 American Social Problems 3 UNITS - (UC:CSU)

Lecture 3 hours.
Advisory: English 28 and 67 or equivalent.

Students apply sociological perspectives and concepts in analyzing contemporary social problems in the United States. Problems associated with drug abuse, poverty, racial, ethnic, and gender inequality, crime and violence, and the environment are some of the topics addressed.

SOCIOLOGY 11 Ethnic and Racial Minorities in the United States 3 UNITS - (UC:CSU)

Lecture 3 hours.
Advisory: English 28 and 67 or equivalent.

Examines global racial and ethnic relations with an emphasis on the United States. There will be extensive use of several theoretical perspectives and an analysis of historical records in explaining minority/majority relations, prejudice and discrimination, and the political and economic status of various racial and ethnic groups. There will be extensive references to contemporary research findings on majority/minority group relations.

SOCIOLOGY 12 Marriage and Family Life 3 UNITS – (UC:CSU)

Lecture 3 hours.
Advisory: ENGLISH 28 and 67.

Students learn to use theory and research to examine the family and other forms of intimate-partner relationships that exist within a diverse, multicultural society. The students analyze these structures and their functions along with historical changes, emerging variant patterns, and the influence of contemporary society on the family.

SPANISH

One year of high school study in Spanish corresponds to one college semester or one college semester equals one full year of high school study. Required courses: Spanish 1*, 2*, 3, 4 and 8*. These courses are required only for students who plan to teach Spanish.

SPANISH 1 Elementary Spanish I 5 UNITS - (UC: CSU)

*Lecture 5 hours. Laboratory 1 hour.
Advisory: English 28 and 67.*

Pronunciation and grammar, practical vocabulary, useful phrases; basic facts on the geography, customs and culture of the Spanish-speaking world.

UC accepts one of Spanish 1 or equivalent.

SPANISH 2 Elementary Spanish II 5 UNITS - (UC:CSU)

Lecture 5 hours. Laboratory 1 hour.

Prerequisite: Spanish 1 with a satisfactory grade or equivalent.

Completes elementary Spanish I with emphasis on reading and writing of elementary texts and emphasizes the spoken language.

SPANISH 3 Intermediate Spanish I 5 UNITS - (UC:CSU)

Lecture 5 hours.

Prerequisite: Spanish 2 with a satisfactory grade or equivalent.

A review of grammar and idiomatic construction. Also, an introduction to Spanish and Spanish American writers through readings of short stories, as well as a review of cultural aspects relative to the Spanish-speaking world.

SPANISH 4 Intermediate Spanish II 5 UNITS - (UC:CSU)

Lecture 5 hours.

Prerequisite: Spanish 3 with a satisfactory grade or equivalent.

Advisory: English 28 and 67

Review of grammar, composition and vocabulary building. The review of Spanish and Latin American authors and cultural aspects is continued.

SPANISH 5 Advanced Spanish I 5 UNITS - (UC: CSU)

Lecture 5 hours.

Prerequisite: Spanish 4 with a satisfactory grade or equivalent.

An overall examination of the arts and the concept of aesthetics in preparation for the study of literature. The focus is on the narrative (short story and novel) and poetry in Spanish and Latin American literary traditions. The course also examines the translation to film of some of the works studied. Discussions generated by lectures and readings provide oral practice in the target language. Written expression and review of grammatical structures, orthography and punctuation is done through essays on selected themes.

SPANISH 6 Advanced Spanish II 5 UNITS - (UC:CSU)

Lecture 5 hours.

Prerequisite: Spanish 5 with a satisfactory grade or equivalent.

The thrust of the course is a study of theater as a literary and performing art, and the essay as a non-fictional form of expression. Through lectures and readings, students will learn about the trajectory of the theater and the essay in Spanish and Latin-American literary traditions. Discussions generated by lectures and reading provide for oral practice in the target language. Written expression and review of grammatical structures, orthography and punctuation is done through essays on selected themes.

SPANISH 8 Conversational Spanish 2 UNITS - (RPT 3) (UC:CSU)

Lecture 2 hours.

Prerequisite: Spanish 2 with a satisfactory grade or equivalent.

Oral expression in Spanish is the main thrust of the course. The focus is on conversational skills revolving around everyday situations that a person may encounter when traveling or living in Spanish-speaking countries, or when interacting with Spanish-speaking people in the United States. UC limit: maximum credit allowed, 2 times (4 units).

SPANISH 9 Hispanic Civilization 3 UNITS - (UC:CSU)

Lecture 3 hours.

Advisory: English 28 and 67.

Geography, history, government and institutions of Spain; the life and customs of the people; the literature, music and art; and the contributions to civilization. Conducted in English.

SPANISH 10 Latin American Civilization 3 UNITS - (UC:CSU)

Lecture 3 hours.

Advisory: English 28 and 67.

The histories, cultures, and arts of Latin America are explored. Differences and similarities between the countries that comprise Latin America, noting forces that unify as well as divide, is the focus of the course. Students explore the relationship between Latin America and the United States throughout their histories.

SPANISH 11 Great Books of Spanish Literature 3 UNITS - (RPT 1) (UC:CSU)

Lecture 3 hours.

Advisory: English 28 and 67. Lecture 3 hours.

Students are introduced to selections from masterpieces of Spanish Literature. Conducted in Spanish.

SPANISH 14 Spanish for Public Service Personnel 3 UNITS - (CSU)

Lecture 3 hours.

Advisory: English 28 and 67.

This course is designed for public service employees such as police officers and fire fighters. It emphasizes practical usage of Spanish for personnel who serve the Spanish speaking community.

SPANISH 15
Great Books of Latin American Literature
3 UNITS - (UC: CSU)

Lecture 3 hours.

Advisory: English 28 and 67.

Selections from the great masterpieces of Latin American Literature. Conducted in Spanish.

SPANISH 21
Fundamentals of Spanish I
3 UNITS - (UC: CSU)

Lecture 3 hours. Laboratory 0.5 hour.

Advisories: English 28 and 67.

Introduces the fundamentals of the Spanish pronunciation and grammar structure. Offers practical material for simple conversation based on everyday experiences. Spanish 21 and Spanish 22 are together equivalent to Spanish 1.

SPANISH 22
Fundamentals of Spanish II
3 UNITS - (UC:CSU)

Lecture 3 hours. Laboratory 0.5 hour.

Advisories: English 28 and 67.

Continues the presentation of the fundamentals of Spanish pronunciation and grammar structure. Offers practical material for simple conversation based on everyday experiences. Spanish 21 and Spanish 22 together are equivalent to Spanish 1. Class assignments will require 0.5 hours TBA per week in the Foreign Language Laboratory- DH 319.

SPANISH 35
Spanish for Spanish Speakers I
5 UNITS - (UC:CSU)

Lecture 5 hours. Laboratory 1 hour.

Advisory: English 28 and 67.

(Equivalent to Spanish I)

The bilingual student practices written Spanish with an emphasis on the acquisition of a solid grammatical base, vocabulary enrichment, and spelling. Addresses all four skills in Spanish, but focuses on reading and writing. Includes readings on the geography, customs and culture of Spain and Latin America.

SPANISH 36
Spanish for Spanish Speakers II
5 UNITS - (UC:CSU)

Lecture 5 hours. Laboratory 1 hour.

Prerequisite: Spanish 35.

(Equivalent to Spanish 2)

A continuation of Spanish 35. Completes the study of grammar and continues the development of reading and writing skills. Further study of Spanish and Latin American culture and civilization. Conducted in Spanish.

SPANISH 123 ARCHIVED
Fundamentals of Elementary Spanish I
3 UNITS - (UC:CSU)

SPANISH 124 ARCHIVED
Fundamentals of Elementary Spanish II
3 UNITS - (UC:CSU)

SPEECH

SPEECH 60
Listening and Speaking Laboratory
1 UNIT

Co-requisite: Speech 71, or Speech 72, or Speech 73, or Speech 113.

This Speech course consists of 4 modules that provide laboratory practice among topics such as speech, articulation, rate and accuracy, speech phrasing, intonation, stressed syllables in words phrases, and phonemic contrast and length, pertaining to the effect on the speaker's intended meaning.

The modules are co-requisites for Speech 71, Speech 72, Speech 73, and Speech 113. The co-requisites are for persons who use English as a Second Language. Each co-requisite supplements usage of the most common words in English.

SPEECH 60A
Listening and Speaking Laboratory
0.25 UNITS

Lecture .50 hour.

Prerequisite: ESL 3C or Appropriate placement score.

Co-requisite: Speech 71.

A level four laboratory course for persons who use English as a Second Language who are currently enrolled in Speech 71. Supplements usage of the most common words in English, their pronunciation practice and their usage in a speech laboratory setting. Develops skill in pronunciation of basic spoken English.

SPEECH 60B
Listening and Speaking Laboratory
0.25 UNITS

Laboratory .5 hour.

Prerequisite: Speech 60A and Speech 71 or appropriate placement score Co-requisite: Speech 72.

A level five laboratory course for persons taking Speech 72 who use English as a Second Language. Supplements usage of the most common words in English, their pronunciation practice and their usage in a speech laboratory setting. Develops skill in pronunciation of basic spoken English.

SPEECH 60C
Listening and Speaking Laboratory
0.25 UNITS

Laboratory .5 hour.

Prerequisite: Speech 60B and Speech 72 or appropriate placement score.

Co-requisite: Speech 73

A level six laboratory course for persons taking Speech 73 who use English as a Second Language. Supplements usage of the most common words in English, their pronunciation practice and their usage in a speech laboratory setting. Develops skill in pronunciation, syllable stress and word stress and intonation of basic spoken English.

SPEECH 60D
Listening and Speaking
Laboratory
0.25 UNITS

Laboratory .5 hour. Prerequisite: Speech 73 and Speech 60C or appropriate placement score.
Co-requisite: Speech 113.

A level seven laboratory course for persons taking Speech 113 who will use English as a Second Language in their college transfer course. Supplements usage of the most common and major-related technical words in English, their pronunciation practice and their usage in a speech laboratory setting. Develops fluency in articulation, pronunciation and prosody (pitch, loudness, rate and rhythm) during structured speech and conversational situations.

SPEECH 61
Speech Clinic
1 UNIT - (RPT 3) NDC

Laboratory 3 hours.
Advisory: Speech Communication 113 with a satisfactory grade and English 28 and 67 or equivalent.

Students receive individualized training from instructors and are involved in computer-aided speech exercises, conversation groups, and speaking sessions with volunteer listeners. Students work on mastering Standard American English, improving receptive and expressive language skills, and achieving other speech communication objectives. As needed, therapeutic assistance is provided to students with articulation, fluency, language and voice disorders.

SPEECH 71
Speaking English as a Second Language I
3 UNITS - NDC

Lecture 3 hours.
Prerequisite: ESL 3A, 3B, and 3C. Appropriate placement score.
Co-requisite: Speech 60A

A level four course for persons who use English as a second language. Stresses the most common words in English, their pronunciation and usage. Develops skill in basic spoken English communication.

SPEECH 72
Speaking English as a Second Language II
3 UNITS - NDC

Lecture 3 hours.
Prerequisite: ESL 4A/4B and Speech 71 and 60A or appropriate placement score
Co-requisite: Speech 60B.

A Level Five course for persons who use English as a second language. Stresses expanding vocabulary utilizing the most common words in English, their pronunciation and their usage along with usage of idiomatic expression, figurative language, etc. Develops skills in listening and basic spoken English communication.

May not be taken concurrently with any speech class other than Speech 60B.

SPEECH 73
Speaking English as a Second Language III
3 UNITS - NDC

Lecture 3 hours.
Prerequisite: Speech 72 and 60B or appropriate placement score
Co-requisite: Speech 60C.

May not be taken concurrently with any speech class other than Speech 60C.

A level six intensive speech course for persons who use English as a Second Language who may have adequate reading and grammatical skills but need more help in articulation, pronunciation and oral composition.

TRANSFER COURSES

SPEECH 101
Oral Communication I
3 UNITS - (UC:CSU)

Lecture 3 hours.
Advisory: English 101 or 28, 67 or appropriate score on the College Placement

SPEECH 101 is a Public Speaking course which gives students techniques and practice in Informative and Persuasive extemporaneous public speaking performances utilizing effective outlining, structure and style.

SPEECH 102
Oral Communication II
3 UNITS - (UC:CSU)

Lecture 3 hours.
Prerequisite: Speech Communication 101 and English 101.
 Advanced instruction and practice in the art and skill of public speaking with particular focus on real-world speaking situations.

SPEECH 104
Argumentation 1
3 UNITS - (UC:CSU)

Lecture 3 hours.
Prerequisite: Speech Communication 101
Advisory: English 101.

A study of the theory and uses of argumentation and critical thinking, including research and use of evidence and reason. Application of critical thinking skills to construct and analyze oral and written arguments. Meets AA degree and transfer requirements in critical and analytic thinking.

SPEECH 106
Forensics
2 UNITS - (RPT 3) (CSU)

Lecture 1 hour. Laboratory 3 hours.
 Students develop the skills to research, prepare, and competitively deliver oral arguments in a debate or individual event at intercollegiate forensics tournaments.

SPEECH 111
Voice and Articulation
3 UNITS - (CSU)

Lecture 3 hours.
Advisory: English 28 and Speech Communication 113.
 Study and practice of methods of voice development, speech sound production, articulation, pronunciation and prosody.

SPEECH 113
English Speech as a Second Language IV
3 UNITS - (RPT 1) (CSU)

Lecture 3 hours.
Pre-requisite: Speech 73 Speech 60C or appropriate placement score. Co-requisite: Speech 60D.
 A level seven intensive speech course for persons who use English as a second language who may have adequate reading, grammatical and writing skills but need more help in specific areas of articulation, pronunciation and oral composition.

SPEECH 121
The Process of Interpersonal Communication
3 UNITS - (UC:CSU)

Lecture 3 hours.

Advisory: English 28 and Speech Communication 113 with a satisfactory grade.

Provides practice in informal speaking situations which take place when two to five people talk. Covers self concept, feedback, perception, verbal and non-verbal communication, and listening. Communication barriers and break-downs studied. Classroom experimentation and exercises provide understanding and awareness of the skills necessary for successful interpersonal communication.

SPEECH 122
Communication Across Cultures
3 UNITS (UC:CSU)

Lecture 3 hours.

Prerequisite: Speech 121 and English 101

Analysis of cultural influence on human communication acts. This class focuses on the processes and problems of intercultural communication in multi-cultural, multiethnic urban environments. Emphasis on gender, political, economic, and both nonverbal and verbal interpersonal forces.

SPEECH 130
Introduction to Oral Interpretation of Literature
3 UNITS - (UC:CSU)

Lecture 3 hours.

Advisory: English 28 and 67 or equivalent with a satisfactory grade.

Students use oral interpretation to express the printed word. Stresses techniques of discovering an author's meaning and expressing those meanings to an audience through reading aloud.

UC accepts only one of Speech Communication 130 or Theatre 210. Meets both AA Degree and CSU Transfer requirements in Humanities

SPEECH 162
Communication Disorders
3 UNITS (CSU)

Lecture 3 hours.

Prerequisites: Speech 111 and Speech 121

This course is designed for students interested in communication disorders such as stuttering, vocal pathologies, child language delays, autism and articulation disorders. The course outlines the development of speech and language including normal language acquisition. Focus on guidelines for determining normal and disordered speech and language development. This course also discusses career paths related to Speech-Language Pathology.

SPEECH 185 DIRECTED STUDY-
1 UNIT (CSU)

SPEECH 285 DIRECTED STUDY -
2 UNITS (CSU)

SPEECH 385 DIRECTED STUDY -
3 UNITS (CSU)

Allows students to pursue Directed Study on a contract basis under the direction of a supervising instructor.

Prerequisite: 2.5 grade point average and at least 6 units of transferable Speech Communication courses and approval of the project.

Refer to the "Directed Study" section of this catalog for additional information.

Credit Limit: A maximum of 3 units in Directed Study may be taken for credit

SUPERVISION

SUPERVISION 1
ELEMENTS OF SUPERVISION
3 UNITS - (CSU)

Lecture 3 hours.

Open to all students.

Prerequisites: English 28 and 67 or equivalent.

Students learn leadership capability for persons in supervisory positions in business, industry or government organizations

SUPERVISION 12
Written Communications for Supervisors
3 UNITS - (A)

Lecture 3 hours.

Advisory: English 28 and 67 or equivalent.

This course teaches the fundamentals of written communications, aimed at managers and supervisors. Includes principles of business letter writing, audience analysis, preparation of memos, reports and technical documentation

TELEVISION

TELEVISION 1
Introduction to Television
3 UNITS - (CSU)

Lecture 3 hours.

Open to all students.

A required basic course for all first semester Television majors. Recommended elective for Journalism, Theatre and Public Relations.

Students study what's on Television and why, including the history of Radio and Television Broadcasting. They also learn costs, ratings, the FCC rules, cable and pay Television.

TELEVISION 4
Camera Lighting and Sound for Television and Cinema
3 UNITS - (A)

Lecture 3 hours.

A required basic course for all first semester Television majors. Open to all students.

Students learn to operate basic camera, lighting and audio recording equipment for both video and film media in studio and on location.

TELEVISION 6
Studio and Remote Production
3 UNITS - (RPT 1) (A)

Lecture 1 hours. Laboratory 4 hours.

Prerequisite: Television 46 with a satisfactory grade or better.

Advisory: Cinema 2

Students light and shoot remote setups then edit those pieces for inclusion into a half hour live to tape production in the studio.

TELEVISION 7
Television Announcing I
3 UNITS - (RPT 1) (CSU)

Lecture 1 hour. Laboratory 4 hours.

Students create and write a number of stories as part of training in Television announcing for broadcast news, sports, weather, and commercials. They act as on-camera talent in the production of a half hour in-studio live-to-date production.

TELEVISION 9
Introduction to TV Equipment Procedures
3 UNITS - (CSU)

Lecture 3 hours. Advisory: Television 4

A required basic course for all first semester TV majors. Open to all students.

Students learn the principles and operation of a television control room and studio equipment leading to the production of their own live-switched one-minute commercial. Sound control, studio lighting, control room procedures, video camera operation, directing, script writing, storyboarding, and production design are emphasized.

TELEVISION 25
Television and Film Dramatic Writing
3 UNITS - (RPT 1) (CSU)

Lecture 3 hours.

Advisory: English 21

Open to all students.

Professional methods and techniques of television writing for drama or comedy on film and tape. Also deals with obtaining an agent and selling a script.

TELEVISION 46
Television Production
3 UNITS - (RPT 1) (CSU)

Lecture 2 hour. Laboratory 2 hours.

Prerequisite: Television 9 with a satisfactory grade.

Advisory: Television 4

Required of all Television majors.

Students write, produce, and direct a series of three live-switched productions beginning with a 30-second commercial followed by two longer and more complex television programs.

TELEVISION 48
Television Programming and Video Tape Production Workshop
3 UNITS - (RPT 1) (CSU)

Lecture 2 hours. Laboratory 2 hours.

Prerequisite: Television 46 with a satisfactory grade. Required of all Television majors.

Advanced work in pre-producing, directing, producing, writing, operating remote equipment, and special effects.

TELEVISION 49
TV Production Workshop
3 UNITS - (RPT 1) (A)

Lecture 2 hour. Laboratory 2 hours.

Prerequisites: Television 46 with a satisfactory grade.

Students train in the technical aspects of television production, including lighting, camera, videotape and character generator. No script writing or producing, this class is for studio technical crew only.

TELEVISION 55
Digital Video Production Workshop I
3 UNITS - (RPT 1) (A)

Lecture 1 hour. Laboratory 4 hours.

Prerequisite: Cinema 1, 2, and Television 4, 9.

Intermediate film and television students produce short video projects using digital video cameras and editing systems.

TELEVISION 60
Non-linear Editing With Final Cut Pro
3 UNITS - (RPT 1) (A)

Lecture 2 hours. Laboratory 2 hours.

Prerequisite: Television 55 with a satisfactory grade.

Advanced television students are introduced to Final Cut Pro non-linear software and are given lectures of film-to-video and other post production techniques. .

TELEVISION 185
Directed Study — 1 UNIT - (CSU)

TELEVISION 285
Directed Study — 2 UNITS - (CSU)

TELEVISION 385
Directed Study — 3 UNITS - (CSU)

Lecture 1 hour per unit.

Prerequisite: Television 46 with satisfactory grades or better.

Note: Courses limited to advanced LACC Television Students. Courses offered on a Credit/No Credit basis. Credit Limit: A maximum of 3 units in Directed Study may be taken for credit. Allows students to pursue directed study in Television on a contract basis under the direction of a supervising instructor. Refer to the “Directed Study” section of this catalog for additional information. .

TELEVISION 911
Cooperative Education — 1 UNIT - (RPT1)

Students receive credit for approved internships with an employer in the field of Motion Picture Production, under the direction of the Cooperative Education director. The worksite must be approved by The Department Chair.

THEATER

Note: that some courses offered may be offered every other semester, or less frequently. Students must receive a satisfactory grade in all Theater courses taken and have completed those courses within eight years to meet requirements.

NOTE: Not every class is offered each semester. Refer to the current class schedule for current class offerings.

PREREQUISITES: Specified prerequisites must be completed with a satisfactory grade or equivalent.

THEATER 100 **Introduction to the Theatre** **3 UNITS - (UC:CSU)**

Lecture 3 hours.

Advisory: English 101 or equivalent.

A survey study and analysis of the various elements that make up the institution called the Theatre. Subjects range from origins of primitive drama to contemporary structure and direction of our modern Theatre.

THEATER 105 **Drama Digest** **1 UNITS - (RPT 3) (CSU)**

Lecture 1 hour.

Enrollment required of Theater majors each semester of attendance.

The student's theatrical experience is enriched through the observation of regularly scheduled programs consisting of acting scenes and exercises from the various Theater classes. The basic program is augmented by the appearance of guest artists or theater groups.

THEATER 110 **History of the World Theatre** **3 UNITS - (UC:CSU)**

Lecture 3 hours.

Advisory: English 101 or equivalent.

A history study and exploration of Western theatre and its traditions from its primitive beginnings up to the present.

THEATER 200 **Introduction to Acting** **3 UNITS - (UC:CSU)**

Lecture 3 hours.

Through lecture, discussion, demonstration, and various participation exercises, the student is introduced to the art and craft of acting.

THEATER 205 **Actor's Orientation to Professional Theatre** **2 UNITS - (RPT 1) (CSU)**

Lecture 1 hour. Laboratory 2 hours.

Co-requisite: Theater 270.

The student learns about a career as a professional actor in the American entertainment industry including methodology and techniques for seeking and gaining employment in Theater, Film, Television, Commercials, and New Media, which includes all forms of electronic performance.

THEATER 210 **Introduction to Oral Interpretation of Dramatic Literature** **3 UNITS - (RPT 1) (UC:CSU)**

Lecture 3 hours.

Prerequisite: Theater 270 with a satisfactory grade.

A study of the techniques of oral interpretation including phrasing, inflection, work relish, verse scansion, tempo and rhythm – designed to develop the actor's interpretive skills.

THEATER 225 **Beginning Direction** **3 UNITS - (UC:CSU)**

Lecture 3 hours.

Prerequisite: Theater 270 with a satisfactory grade.

Beginning with play analysis from a director's point of view to creating a directorial vision, the course includes an introduction to the basic principles of stage directing and the fundamental working techniques for the realization of the values of a play on stage. Also covered is the development of an organizational methodology and study of the professional protocols for the direction of a one act play. This is done through lectures, reading assignments, class exercises and demonstrations and the preparation of a complete director's prompt book.

THEATER 232 **Play Production** **2 UNITS - (RPT 3) (UC:CSU)**

Laboratory 6 hours.

The student is given the opportunity to work intensely in one or more areas associated with production: acting, voice, movement, management, costuming or technical theatre. Students must be prepared to work irregular hours.

THEATER 235 **Play Production** **5 UNITS - (RPT 3) (UC:CSU)**

Laboratory 30 hours.

This course is generally offered in the summer session only. The student is given an opportunity to work intensely in one or more production areas: acting, management, costuming, or technical theatre. Students must be prepared to work irregular hours.

THEATER 240 **Voice and Articulation for the Theatre** **3 UNITS - (UC:CSU)**

Lecture 3 hours.

Note: Credit allowed for only one of Theater 240 or Speech Communication 111.

Developing of voice and speech skills, emphasizing clarity, precision, tone, dynamics and imaginative use of language. Individual goals will be set for performance and standards of improvement to help the student acquire the basics of good theatre speech.

THEATER 242 **Voice Development Workshop** **3 UNITS - (RPT 3) (CSU)**

Laboratory 6 hours.

Through various vocal and physical exercises, discussion, and demonstration the student actor gains skill in physical alignment, release of habitual tension in breathing and vocal musculature, development of rich resonance and clear articulation. (For Theatre Academy students only.)

THEATER 243**Dialects****2 UNITS - (RPT 1) (CSU)**

Lecture 1 hour. Laboratory 2 hours.

Prerequisite: Theater 240

Students learn how to speak in dialects through both the International Phonetic Alphabet and the observation of professional actors. Dialects include Upper Class British, Cockney, Australian, Scottish, and New York.

THEATER 262**Special Projects****2 UNITS - (RPT 3) (CSU)**

Laboratory 4 hours.

Prerequisite: Theater 270 with a satisfactory grade.

Advanced students are given the opportunity to plan, rehearse, stage and produce approved all student projects for presentation before an audience.

THEATER 269**Period Movement****2 UNITS - (CSU)**

Lecture 1 hour. Laboratory 2 hours.

Advisory: Theater 270 or equivalent.

A study is made of the acting styles and period movement from the Greek to Victorian periods of Western history. Class work includes video demonstrations, movement instruction, and individual coaching. Movement styles of each period are incorporated into each of the period scenes.

THEATER 270**Beginning Acting****3 UNITS - (UC:CSU)**

Lecture 2 hours. Laboratory 4 hours.

The students receive an introduction to the art and craft of acting. This class is the first level of the Theater Academy's Professional Training Program's acting option.

Students perform on stage using the physical body and voice to experience the process of the actor. Topics covered include: basic stage technique, movement values, relaxation, body awareness, physical limbering and alignment, pantomimic dramatization, play and scene study. Students receive an introductory appreciation of how an actor trains for a career in theater, film and television as they develop their own skills of physical, verbal and emotional communication.

THEATER 271**Intermediate Acting****2 UNITS - (UC:CSU)**

Lecture 1 hour. Laboratory 2 hours.

Prerequisite: Theater 200

Acting principles are expanded and applied in staged scenes. The emphasis is on comprehension, translation into meaningful dramatic action, and creation. The actor's self awareness is explored and developed before a classroom audience.

THEATER 272**Intermediate Applied Acting****3 UNITS - (UC:CSU)**

Lecture 2 hours. Laboratory 4 hours.

Requisite: Theater 270.

The acting principles applied to Theater 270 are expanded and applied in staged scenes. The emphasis is on comprehension, translation into meaningful dramatic action, and creation. The actor's self awareness is explored and developed before a class-room audience.

THEATER 273**Advanced Acting****2 UNITS - (RPT 1) (UC:CSU)**

Lecture 1 hour. Laboratory 2 hours.

Prerequisite: Theater 271 with a satisfactory grade.

Scenes are studied and presented with concentration on characterization, intensity of action, freedom of emotional release, and clarity of expression.

THEATER 274**Advanced Applied Acting****3 UNITS - (RPT 1) (UC:CSU)**

Lecture 2 hours. Laboratory 4 hours.

Prerequisite: Theater 272 with a satisfactory grade.

The student is engaged in greater in depth analysis of staged scenes. Emphasis is placed upon the rehearsal process and rehearsal techniques.

THEATER 275**Scene Study****2 UNITS - (RPT 3) (CSU)**

Lecture 1 hour. Laboratory 2 hours.

Prerequisite: Theater 270 with a satisfactory grade.

The student is engaged in greater in-depth analysis of staged scenes. Emphasis is placed upon the rehearsal process and techniques.

THEATER 276**Actor's Workshop****3 UNITS - (RPT 1) (CSU)**

Lecture 1 hour. Laboratory 5 hours.

Prerequisite: Theater 270.

The actor learns to analyze scenes and speeches, classical, modern, and contemporary, for the most effective interpretations and choices in creating roles for performance. Emphasis on research, characterization, playing actions/reactions, vocal development, emotional centering, discoveries, release, and control, and physical expressiveness.

THEATER 277**Character Analysis****3 UNITS - (RPT 1) (UC:CSU)**

Lecture 3 hours.

Prerequisite: Theater 270.

The course covers the analytical steps involved in the study of a play and the development of a character preparatory to rehearsals and performances.

THEATER 294**Rehearsals and Performances****2 UNITS - (RPT 3) (UC:CSU)**

Laboratory 12 hours.

Prerequisite: Theater 270 with a satisfactory grade.

Experience is given in the acting, directing, and producing of plays for public presentation. Students are required to furnish three glossy photographs — eight by ten inches in size.

THEATER 295**Rehearsals and Performances Lab****3 UNITS - (RPT 3)**

Laboratory 3 hours.

Co-requisite: Theater 274, 276 and 294.

This course allows students currently enrolled in Theater 274, 276, and 294 to use the lab equipment, production support, production venues, and productions to enhance applicable skill necessary for success.

THEATER 300
Introduction to Stagecraft
3 UNITS - (UC:CSU)

Lecture 3 hours.

Survey of the technical phases of play production; for scenery, properties, lighting, sound, costuming, and stage management and organization of stage activity.

THEATER 302
Introduction To Stage Management
3 UNITS - (UC:CSU)

Lecture 2 hours. Laboratory 2 hours.

Advisory: English 28 and 67 or equivalent.

Students learn the function of stage managers in professional theater productions.

THEATER 311
Theatrical Lighting
3 UNITS - (UC:CSU)

Lecture 2 hours. Laboratory 2 hours.

This course will create an understanding of the basic methods, physical techniques, and work ethics of the lighting designer/technician. The process will include training in the creative concepts of design, how to create a light plot as well as in the practical use and operation of the equipment used to execute the design. Specific attention will be paid to entertainment industry safety standards that will prepare the student for work in the industry.

THEATER 313
Scenic Painting for the Theatre
3 UNITS - (CSU)

Lecture 2 hours. Laboratory 2 hours.

This course will create an understanding of the basic methods, techniques, and work habits of the scenic artist. It will include training on equipment, utilization of materials, preparation of painting sequences, and application of processes as well as standard safety practices in the entertainment industry.

THEATER 314
Theatrical Sound Design: Fundamentals, Procedures and Operation
3 UNITS - (CSU)

Advisory: English 28 and 67 /31 or equivalent.

Technical study in the theory and practices is used to set up production sound equipment and related materials utilized in a professional sound design prepared for the theater.

THEATER 315
Introduction to Theatrical Scenic Design
3 UNITS - (UC:CSU)

Lecture 2 hours. Laboratory 2 hours.

Students develop a visual graphic vocabulary in order to express design concepts for scenic environments. Students analyze specific text or events and create graphic documentation in order to communicate ideas and visual concepts. Class projects focus on specific skills and forms of design presentations; script analysis, ground plan and section, elevations, details, model building and computer pre-visualization of virtual environments.

THEATER 325
Stage Management and Advanced Stagecraft
3 UNITS - (RPT 3) (UC:CSU)

Advisory: English 28 and 67/31 or equivalent.

Intensive study of all technical phases of the theatre. Major topics: scenic design, painting, lighting, construction and manipulation of stage scenery; topography and equipment of stages and auditoriums; duties of stage manager, company manager, and technical director.

THEATER 335
Applied Stage Management and Production
4 UNITS - (RPT 3) (UC:CSU)

Laboratory 12 hours.

Advisory: English 28 and 67 or equivalent.

Practical assignments are made in technical and managerial phases of plays prepared for public presentation. Progress is graded in scene shop and stage assignments from assistant to stage manager, master carpenter, property master, master electrician, scenic artists, and set designer. Students must be available for rehearsals and performances.

THEATER 336
Applied Stage Management Lab
3 UNITS - (RPT 3)

Laboratory 3 hours.

Co-requisite: Theater 335.

Advisory: English 28 and 67.

Having been identified and developed through the pre-production phase of the producing process, the practical assignments in the various aspects of technical theatre are further explored and refined by the students during the technical rehearsals and performances of the plays being produced. Students must be admitted into the Academy Technical Theatre Program to participate in this class.

THEATER 338
Introduction to Design: Theatre, Film, and Television
3 UNITS - (UC:CSU)

Lecture 3 hours.

An introduction to the design process for theatre, film, and television. Exploration of; the relationship between text and esthetic design choices, the recognition of basic compositional elements; color, mass, line, texture, rhythm, balance as used in story telling, and the creation of design presentations through collage as well as studying the architectural spaces of story telling, from the proscenium arch to the sound stage.

THEATER 345
Technical Stage Production
4 UNITS - (RPT 3) (UC:CSU)

Laboratory 12 hours.

Co-requisite: Theater 270 or 272

Practical technical experiences preparing and mounting plans for public presentation. Students must be available for rehearsals and performances.

THEATER 346
Technical Stage Production Lab
3 UNITS - (RPT 3)

Laboratory 3 hours.

Co-requisite: Theater 345 and either Theater 270 or 272.

This course allows students currently in Theatre Arts 270, 272, and 345 to use the materials, tools, equipment, production support, production venues, and productions to enhance applicable skills necessary for success in theatre.

THEATER 385
Directed Study - Theater
3 UNITS - (RPT 3)

Lecture 3 hours.

Theater students pursue on their own an in-depth study of a subject of special interest in the field of theater. Consultation with the instructor on a weekly basis, plus independent work is required.

THEATER 400
Costume Periods and Styles
3 UNITS - (UC:CSU)

Lecture 3 hours.

A study of the changes in dress from ancient to modern times, social and political forces influencing costuming for stage, film and television.

THEATER 411
Costuming For The Theatre
3 UNITS - (RPT 2) (CSU)

Lecture 2 hours. Laboratory 2 hours.

Intensive study of techniques and practices of theatrical costuming. Topics include: choice, use and manipulation of patterns, textiles, jewelry and accessories to imitate historical appearances meeting the needs of performance costume rather than clothing. Practical solutions to budget limits and camera media.

THEATER 413
Costume Dyeing and Painting
3 UNITS - (A)

Lecture 2 hours. Laboratory 2 hours.

Practical application of fabric surface design techniques for theatre: various dyes, tie dye, batik, stencil, screening, aging, antiquing and distressing

THEATER 414
Costume Draping and Accessories
3 UNITS - (RPT 2) (A)

Lecture 2 hours. Laboratory 2 hours.

Theory and practice of creating stage and film costumes and costume accessories through draping.

THEATER 415
Costume Design for the Theater
3 UNITS - (A)

Lecture 2 hours. Laboratory 2 hours.

Beginning study of techniques and practices of theatrical costume design and illustration. Topics include: analyzing the play script, research techniques, creating the costume plot, choice and use of media, illustrating costume design for needs of theatrical performance.

THEATER 416
Materials and Methods for the Costumer
3 UNITS - (CSU)

Lecture 2 hours. Laboratory 2 hours.

Advisory: English 28 and 67/31 or equivalent.

Lecture and laboratory study of the properties of various non textile materials used by the costumer including latex, leather, plastics, dyes, glues, foam, rubber and molds.

THEATER 417
Costuming for Film
3 UNITS - (CSU)

Lecture 2 hours. Laboratory 2 hours.

Techniques and practices of costuming for film; analyzing and breaking down the script using computer spreadsheet, creating character boards, design conferences, budgeting, preproduction planning and resourcing.

THEATER 418
Communicating Theatrical Design
3 UNITS - (A)

Lecture 2 hours. Laboratory 2 hours.

Basic methods and techniques for the theatrical designer to communicate both scenic and costume design. Includes perspective drawing, ground plans, shading, textures, character bodies and costume illustration techniques using pencil and colored pencil.

THEATER 419
Advanced Costume Illustration
3 UNITS - (RPT 1) (A)

Lecture 2 hours. Laboratory 2 hours.

Advanced costume illustration for theatre and film, including; advanced figure drawing, sketch artist techniques, computer illustration, rendering textures and creating finished costume plates.

THEATER 420
Costuming on Set
3 UNITS

Lecture 2 hours. Laboratory 2 hours.

Theory and practical experience costuming for film: design conferences, preparation of costumes, and working on set as a costumer for student film project.

THEATER 425
Applied Costuming for the Theatre
4 UNITS - (RPT 3) (CSU)

Laboratory 12 hours.

Advisory: English 28 and 67 or equivalent.

Practical experience in construction and maintenance of costumes for public theatrical presentation. Emphasizing: professional wardrobe/dressing room practices, construction, alteration, maintenance, repair, cleaning and storage of costumes. Students must be available for rehearsals and performances.

THEATER 426
Applied Costuming for the Theater Lab
3 UNITS - (RPT 3)

Laboratory 3 hours.

Co-requisite: Theater 425.

Advisory: English 28 and 67.

Having been identified and developed through the pre-production phase of the costuming processes, the practical assignments in the various aspects of costuming are further explored and refined by the students during the dress rehearsals and performances of production.

THEATER 450
Beginning Stage Make Up
2 UNITS - (UC:CSU)

Lecture 1 hour. Laboratory 4 hours.

Techniques and practices of theatrical makeup design and application. Facial analysis, glamour, aging of the face, beards, stylized, and impersonation makeups are performed by the student on their own face. Topics include the use of makeup for film and television

THEATER 185
Directed Study -
1 UNITS (CSU)

THEATER 285
Directed Study -
2 UNITS (CSU)

Prerequisite: Theater 270 with a satisfactory grade.

Allows students to pursue Directed Study on a contract basis under the supervision of an instructor. Please refer to the "Directed Study" section of this catalog for additional information.



Workforce Readiness Academy

ALL COURSES ARE ALSO OFFERED ON A "STAND-ALONE" BASIS AS WELL**

on-Credit Courses by Skills Certificate

Skills Certificate Programs of Completion and Competency

ENTREPRENEURSHIP SKILLS CERTIFICATE

This Skills Certificate encompasses two non-credit courses. Upon completion of this course, students will receive an Entrepreneurship Skills Certificate. Students will be given basic tools on how to start a small business.

Courses	Class Hours
VOCED 083 CE Young Entrepreneur	Class Hrs. 36
VOCED 239 CE Blueprint for Customer Service	Class Hrs. 18

IN-HOME SUPPORTIVE SERVICES SKILLS CERTIFICATE

This Skills Certificate includes one non-credit course from Workforce Education. The In-Home Supportive Services (IHSS) course is a 54-hour program that provides training on in-home care. Students are also given CPR/FA training as part of the curriculum. Upon successful completion of this course, students will receive an In-Home Supportive Services Skills Certificate of Competency.

Courses	Class Hours
VOCED 002 CE In-Home Supportive Services	Class Hrs. 70
VOCED 059 CE VESL for Home Health Aide	Class Hrs. 18

CITIZENSHIP SKILLS CERTIFICATE OF COMPLETION

This Skills Certificate packages non-credit classes from the Citizenship Department. You will continue through the series and then sign-up to take your Citizenship Interview and oral examination. Upon completion of this series of courses, you will receive a Citizenship Skills Certificate of Completion. In addition, when you pass the INS exam you will become a United States Citizen.

Courses	Class Hours
Citizenship 010 CE Citizenship Through English	Class Hr. 18
Citizenship 012 CE Citizenship Through English	Class Hr. 54
Citizenship 015 CE Citizenship Through English	Class Hr. 54

Nelines Colon-Paladini
Coordinator of Non-Credit Programs
(323) 953-4000 ext. 2230

Devon M. Werble
Instructional Director; Faculty Curriculum Development
(323) 953-4000 ext. 2236

Citizenship 030 CE	English Literacy and Civics	Class Hr. 108
Citizenship 031 CE	English Literacy and Civics	Class Hr. 108
Citizenship 032 CE	English Literacy and Civics	Class Hr. 108

ENGLISH AS A SECOND LANGUAGE SKILLS CERTIFICATE OF COMPLETION

This Skills Certificate packages the series of courses from our non-credit ESL department. You will be assessed, then placed in the accurate course and continue through the progression of the classes at your own pace to ensure a high-level of comprehension and positive learning outcomes. Upon completion of this series of courses, you will receive an English as a Second Language Skills Certificate of Completion.

Courses	Class Hours
ES 006 CE ESL 0	Class Hr. 12
ESL 007 CE ESL 1	Class Hr. 12
ESL 008 CE ESL 2	Class Hr. 12
ESL 009 CE ESL 3	Class Hr. 12

HOSPITALITY SKILLS CERTIFICATE OF COMPETENCY

This Skills Certificate encompasses all of the Hospitality courses provided by the American Hotel and Lodging Association. Upon completion of this training, you will receive a Hospitality Skills Certificate of Competency in any one of below courses. In addition you have the opportunity to take one of the exams from the association in any of the below courses which are of interest. This will assist you in obtaining employment and/or advancing in your current occupation.

Courses	Class Hours
VOCED 242 CE Banquet Server Skills Training	Class Hrs. 6
VOCED 243 CE Front Desk Representative-Making a Good Impression	Class Hrs. 6
VOCED 244 CE Laundry Attendant Skills Training	Class Hrs. 6
VOCED 245 CE Public Space Cleaner Skills Training	Class Hrs. 6
VOCED 246 CE Restaurant Server Skills Training	Class Hrs. 6
VOCED 247 CE Kitchen Steward Training Skills	Class Hrs. 6
VOCED 248 CE Maintenance Employee Skills Training	Class Hrs. 6
VOCED 249 CE Reservationist Skills Training	Class Hrs. 6
VOCED 250 CE Guestroom Attendant Skills Training	Class Hrs. 6

JOB READINESS SKILLS CERTIFICATE OF COMPLETION

This Skills Certificate encompasses a series of specific non-credit courses designed to introduce and train new workers, incumbent workers, and dislocated workers to the realities of the workplace. Upon completion of these combined courses, you will receive a Job Readiness Certificate of Completion which will assist you in obtaining employment. This certificate is also recognized by the City of Los Angeles and the Los Angeles Chamber of Commerce as a credential

Courses		Class Hours
•	VOCED 001 CE Blueprint for Workplace Success	Class Hrs. 32
•	VOCED 239 CE Blueprint for Customer Service	Class Hrs. 18
•	VOCED 230 CE 30 Ways to Shine as a New Employee	Class Hrs. 6
•	VOCED 236 CE Job Club	Class Hrs. 7

RETAILING SMARTS SKILLS CERTIFICATE OF COMPETENCY

This Skills Certificate encompasses all of the Retail courses provided by the National Retail Federation (NRF). Upon completion of this training, you will receive a Retail Skills Certificate of Competency in addition to Certification from the NRF in either Sales/Customer Service Skills or Supervisory/Management Skills once you pass the online exam with a 75% or higher.

Courses		Class Hours
•	VOCED 241 CE Retailing Smarts 1: Getting to Know your Customer	Class Hrs. 6
•	VOCED 237 CE Retailing Smarts 2: Strategies in Meeting Your Customer's Needs	Class Hrs. 8
•	VOCED 238 CE Retailing Smarts 3: Strategies in Building a Continuous Relationship	Class Hrs. 6
•	VOCED 235 CE Retailing Smarts 4: Going the Extra Mile	Class Hrs. 6
•	VOCED 234 CE Retailing Smarts 5: Explaining Features and Benefits	Class Hrs. 7
•	VOCED 231 CE Retailing Smarts 6: Building Sales	Class Hrs. 6
•	VOCED 232 CE Retailing Smarts 7: Closing the Sale	Class Hrs. 4
•	VOCED 233 CE Retailing Smarts 8: Completing the Sales Transaction	Class Hrs. 5

VOCATIONAL ENGLISH AS A SECOND LANGUAGE SKILLS CERTIFICATE OF COMPLETION

This Skills Certificate packages three non-credit courses. The below courses have been created to assist a student in transition from high-level ESL courses to vocational education programs towards a degree or career of their choosing. These three classes provide language skills training for our Limited English Proficient (LEP) population to help them achieve success in vocational education programs. Upon completion of these combined courses, you will receive a VESL Skills Certificate of Completion which will assist them in integrating into academic departments on campus and/or securing employment.

Courses		Class Hours
•	VOCED 079CE VESL A	Class Hrs. 54
•	VOCED 078CE VESL B	Class Hrs. 54
•	VOCED 055CE VESL C	Class Hrs. 54

WORKPLACE LITERACY SKILLS CERTIFICATE

This Skills Certificate encompasses a series of specific non-credit courses. Upon completion of these combined courses, you will receive a Workforce Literacy Skills Certificate which will assist you in obtaining employment through improvement of core competency skills, and/or advance in your current occupation.

Courses		Class Hours
•	VOCED 001 CE Blueprint for Workplace Success	Class Hrs. 32
•	VOCED 239 CE Blueprint for Customer Service	Class Hrs. 18
•	VOCED 230 CE 30 Ways to Shine as a New Employee	Class Hrs. 6
•	VOCED 079 CE Vocational English as a Second Language	Class Hrs. 54
•	VOCED 003 CE Workplace Computing for LEP Population	Class Hrs. 54
•	Basic Skills 007CE Review of Basic Math	Class Hrs. 36
•	Basic Skills 006 CE Review of Basic English	Class Hrs. 36

LIST OF NON-CREDIT COURSES/STAND ALONE CLASSES

CAREER EXPLORATION

These courses are designed to introduce prospective students to an educational and career track into their field of interest. Each of these courses will provide detailed information regarding the occupational outlook including: the steps involved with regards to education, workplace responsibilities and career path progression in your field of interest.

Courses

	Class Hours
• VOC ED Professional Costume Design	Class Hrs. 6
• VOC ED Music Technology	Class Hrs. 6
• VOC ED Radiologic Technology	Class Hrs. 6
• VOC ED Nursing	Class Hrs. 6
• VOC ED Technical Theater	Class Hrs. 6
• VOC ED Photography	Class Hrs. 6
• VOC ED 271 CE Administration of Justice	Class Hrs. 6
• VOC ED 274 CE Cinema & Television	Class Hrs. 6
• VOC ED 277 CE Marketing & Sales	Class Hrs. 6
• VOC ED 280 CE Web Design	Class Hrs. 6
• VOC ED 272 CE Art & Graphic Design	Class Hrs. 6
• VOC ED 275 CE Computer Applications	Class Hrs. 6
• VOC ED 278 CE Medical Administrative & Billing	Class Hrs. 6
• VOC ED 273 CE Business Administrative	Class Hrs. 6
• VOC ED 276 CE Legal Office Assistant	Class Hrs. 6
• VOC ED 279 CE Office Administration	Class Hrs. 6
• VOC ED 266 CE Computer Operators / Technology	Class Hrs. 6
• VOC ED 267 CE Dietetic Technician	Class Hrs. 6
• VOC ED 261 CE Paralegal	Class Hrs. 6
• VOC ED 265 CE Computer Product Manufacturing	Class Hrs. 6
• VOC ED 260 CE Child Care Workers	Class Hrs. 6
• VOC ED 262 CE Dental Laboratory Technicians	Class Hrs. 6
• VOC ED 264 CE Food Preparation Workers	Class Hrs. 6
• VOC ED 263 CE Computer Engineering	Class Hrs. 6
• VOC ED 268 CE Retail Management	Class Hrs. 6

VOCATIONAL ENGLISH AS A SECOND LANGUAGE FOR CAREER EXPLORATION

These courses of study are designed to compliment existing vocational/career technical education programs. The courses are intended to specifically meet the needs and interests of non-traditional/non-native students with high employment potential. At the end of your course you will have further developed basic skills and workforce literacy in your field of interest.

Courses

	Class Hours
• VESL 323 CE Art & Graphic Design Careers	Class hrs. 18
• VESL 324 CE Administration of Justice Careers	Class Hrs. 18
• VESL 325 CE Medical Administrative Careers	Class Hrs. 18
• VESL 326 CE Legal Office Careers	Class Hrs. 18
• VESL 327 CE Information Technology Careers	Class Hrs. 18
• VESL 328 CE Cinema and Televisions Careers	Class Hrs. 18
• VESL 329 CE Computer Application Careers	Class Hrs. 18
• VESL 330 CE Computer Science Careers	Class Hrs. 18
• VESL 331 CE Business Careers	Class Hrs. 18

Career Progression: Effective Management in the Workplace**Course Number: 168CE****Course Hours: 36 Hours**

You will build a range of skills essential to effective management, including planning and organizing, managing time and resources, leading and hiring, giving direction, overseeing operations, and resolving employee issues and problems. You will receive practice in each skill set through worksheets and exercises based on real-life situations in today's workplace.

Cultural Awareness in the Workplace**Course Number: 201 CE****Course Hours: 18 hours**

You will learn how to improve your business interactions and workplace operations by becoming more aware of different mentalities, behaviors and customs. You will get practice improving communications and building relations through interactive and small-group exercises.

Career Progression: Applying Critical Thinking in the Workplace**Course Number: 169 CE****Course Hours: 36 Hours**

In this open-entry/open-exit course, you will improve critical thinking skills and analytical ability through exercises targeting different skill sets, such as considering options, making assumptions, reaching conclusions and assessing solutions. The in-class exercises, utilizing both scenarios and visuals, are designed to give you hands-on practice in hypothetical and real workplace situations.

Cultivating Study Habits for LEP Students**Course Number: 071 CE****Course Hours: 72 Hours**

This non credit open entry/exit course will introduce students to proper and effective study habits. Students will develop the expertise and proficiency which will enable them to be master's of their study time. This course is designed for high-level ESL students who are ready to transfer to vocational education departments on campus in pursuit of their educational goals. It is also for those who need a review of what it means to be a successful student. At the end of the course you will be prepared for academic coursework and have the confidence to succeed in any college level course.

Workplace Communication: Leadership Skills and Team Building**Course Number: 092 CE****Course Hours: 54 Hours**

This course will introduce you to the skills sets that everyone needs in order to be self-directed. You can be a powerful agent for change, an influencer during the adoption of a new initiative, or a model of productivity and commitment.

Workplace Communication: Team Dynamics**Course Number: 093 CE****Course Hours: 54 Hours**

This open-entry/exit course is designed to reinforce the importance of communication in the workplace. The topics covered include but are not limited to: project communication, expectations, closeout reporting and easy templates. The curriculum is modifiable for incumbent workers and

dislocated workers seeking employment.

Retailing Smarts: Customer Service and Sales**Course Number: 094 CE****Course Hours: 90**

This course is designed to introduce prospective workers to the field of retail and/or reinforce skills and strategies necessary for achieving customer satisfaction by incumbent workers in the industry. The curriculum is provided by the National Retail Federation (NRF). After completing the training, you have the option to take an online exam provided by the NRF, upon a passing score, students will receive a Certification in Customer Service and Sales which is recognized nationally.



Pictured from left: Vania Jara, Nelines Colon-Paladini and Devon M. Werble

The LACC Workforce Readiness Academy was voted "Best Workforce Development Program" at the LA Community College District's Excellence in Workforce Development Awards, held in May 2008. The District's eighth annual event also honored the program with a first place trophy in the category "Successful Encouragement of Special Populations." This academy is a vital part of LACC and its courses are taught in the City College at Wilshire building, 3020 Wilshire Blvd. The program is focused on non-credit workforce education and enables students to enter various career ladder pathways.



CITY COLLEGE AT WILSHIRE

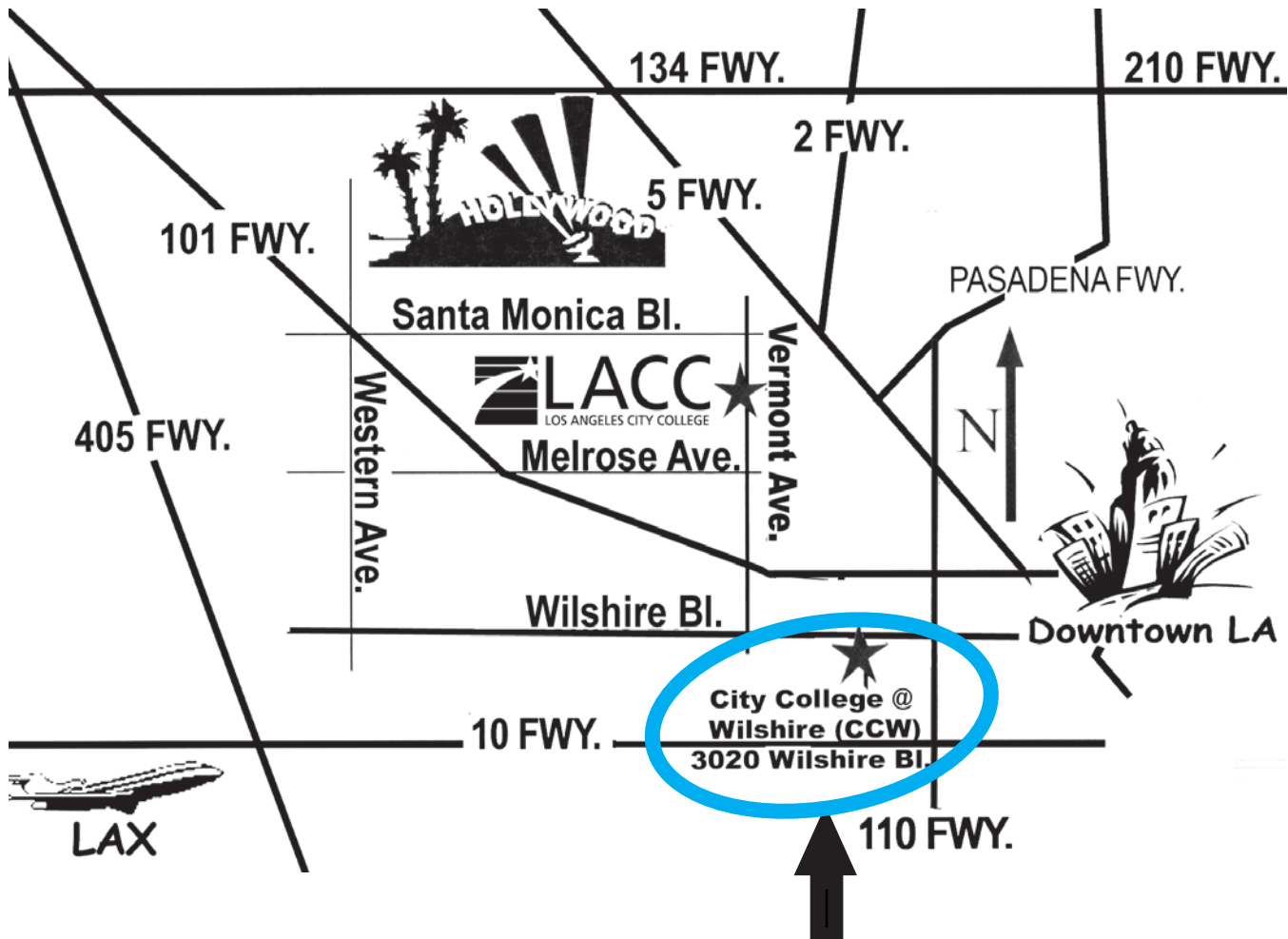

Located just two blocks east of Vermont on the corner of Wilshire Place and Wilshire Blvd. Parking is available under the building, off of Sunset Place.

- ◆ Civics/Citizenship courses
- ◆ Community Services, non-credit, short-term classes
- ◆ English as a Second Language - credit and non-credit
- ◆ Workforce Development classes

NON-CREDIT COURSES

NOTE: Not every class is offered each semester. Refer to the current class schedule for current class offerings.

ENGLISH LITERACY AND CIVICS COURSES

ENGLISH LITERACY AND CIVICS 0 030 CE 0 UNITS

Prerequisite: None

This open-entry Literacy and Civics class will encompass all the content necessary in order to have a functioning understanding of the English language. Students will be exposed to a variety of contexts which will prepare them for encounters in the real world. The exposure in turn will provide them with basic survival skills and assist them in the immersion into a predominately English speaking society.

ENGLISH LITERACY AND CIVICS 1 031 CE 0 UNITS

Prerequisite: None

This open-entry Literacy and Civics class will encompass all the content necessary in order to have a functioning understanding of the English language. Students will be exposed to a variety of contexts which will prepare them for encounters in the real world. The exposure in turn, will provide them with basic survival skills and assist them in the immersion into a predominately English speaking society.

ENGLISH LITERACY AND CIVICS 2 032 CE 0 UNITS

Prerequisite: None

This open-entry course will review the content taught in English Literacy and Civics 0-1, build upon the grammatical and vocabulary structures taught in the previous two classes, and serve as a continuation into ESL level 2. The four components of Literacy will be covered: listening, speaking, reading and writing. The emphasis on these four skills will be contextualized in order for the students to grasp everyday conversations, and situations they may encounter while completing forms such as job applications and US CIS (INS) forms.

ESL AND CIVICS -1 010 CE 0 UNITS

Prerequisite: None

This competency-base, open-entry citizenship course introduces U. S. History and government with the appropriate English vocabulary and grammar structure for beginning English as a Second Language (ESL) student who are preparing to take the U. S citizenship examination.

ENGLISH AS A SECOND LANGUAGE COURSES

ENGLISH AS A SECOND LANGUAGE BEGINNING -1 001CE 0 UNITS

Prerequisite: None

This course provides instruction in simple reading and writing, basic sentence structure, spelling and phonemic correspondences, and verbal communication skills. Students read and listen to dialogues, compose and practice original dialogues, and perform other activities. Emphasis is placed upon general understanding of simple spoken English, clear pronunciation, and correct grammar.

ENGLISH AS A SECOND LANGUAGE BEGINNING -2 002CE 0 UNITS

Prerequisite: None

This course is designed for students at the middle-beginning level of English acquisition. This course provides instruction in reading and writing, sentence structure, spelling and phonemic correspondences, and verbal communication skills. Students read and listen to dialogues, compose and practice original dialogues, and perform other activities. Emphasis is placed upon general understanding of simple spoken and written English, clear pronunciation, and correct grammar.

VOCATIONAL EDUCATION/ VOCATIONAL ENGLISH AS A SECOND LANGUAGE

VOCATIONAL EDUCATION / IN-HOME SUPPORTIVE SERVICES PROVIDER (IHSS) 02CE

0 UNITS

Prerequisite: None

This course is designed to provide students with the knowledge and necessary information required to apply skills, learned in the classroom and in the laboratory, within actual in-home nursing circumstances. Upon completion of this course students will be a full functioning IHSS.

**VOCATIONAL ENGLISH
AS A SECOND LANGUAGE A 079CE
0 UNITS**

This course is designed for LEP students who need help in developing their basic and content skills related to the world of work. This first course is short-term and will focus on speaking, listening, reading, writing, arithmetic. Additionally, the course will introduce students to the world of work and language used in the workforce.

**VOCATIONAL ENGLISH
AS A SECOND LANGUAGE B 078CE
0 UNITS**

This short-term course is specifically designed for LEP students who need an introduction to the language and the environment of the workplace. Co- worker and customer relations, health and safety in the workplace, and work culture will also be introduced.

**VOCATIONAL ENGLISH
AS A SECOND LANGUAGE A 055CE
0 UNITS**

This course is designed for LEP students who need help in developing their basic and content skills related to the world of work. This is short-term and will focus on speaking, listening, reading, writing, arithmetic. Additionally, the course will introduce students to the world of work and language used in the workforce.

**BLUEPRINT FOR WORKPLACE SUCCESS
238CE**

0 UNITS

Prerequisite: None

This accelerated non-credit course is designed to provide students with the necessary tools and skills in order for them to create a "blueprint" for themselves with respect to the workplace. The topics covered include, but are not limited to, self-discovery, time management, job market realities, workplace skills (in-depth), effective communication, contacting employers, preparing for the interview, getting hired, and keeping your job. Each week there will be two topics covered.

**VESL = VOCATIONAL ENGLISH AS A
SECOND LANGUAGE**

**VESL FOR CHILD DEVELOPMENT 1:
SPECIALIZED VOCABULARY IN
DEVELOPMENTAL THEORIES 054CE
0 UNITS**

This course is specifically designed for LEP students who are interested in taking Child Development courses, but need additional assistance with language before and during the course. Additionally, the students will be taught study skill strategies, and test-taking tools.

**VESL: ENTRY-LEVEL
INTRODUCTION TO RETAIL SALES I 156 CE
0 UNITS**

This non-credit open entry/exit course is designed to give students an introduction to the Retail field. It is designed for limited-English proficient adults to improve their chances of securing employment in a retail sales environment, and to prepare them for Business classes in the credit department. The course content includes: cashier duties, delivery person responsibilities, customer sales, and stock clerks; and vocabulary. This is a short-term class taught over the course of 6 weeks at 6 hours a week.

**VESL FOR HEALTH CAREERS 056CE
0 UNITS**

This non-credit open-entry/exit course is specifically designed for Limited English Proficient students who need to perfect their English in the context of the Healthcare field. The students will learn terminology, vocabulary, pronunciation, and writing skills in order to prepare them for health classes.

**VESL FOR NURSING ASSISTANT 057CE
0 UNITS**

This non-credit open-entry/exit course is designed for LEP students to learn English terminology in the context of the Health Field and more specifically becoming a Nurse Assistant. This is a short-term class which will assist students who will enter into the Nursing Department.

**VESL FOR HOME-HEALTH AID 059CE
0 UNITS**

This non-credit open-entry/exit course is designed for LEP students to learn English terminology in the context of the Health field. This is a short-term class which will assist students who will enter into the Nursing Department.

**VESL: READING FOR OFFICE SKILLS 058CE
0 UNITS**

This is a short-term non-credit open entry/exit course designed for Limited English Proficient adults who are interested in working in an office but need the English skills. The course will prepare them with the vocabulary and strategies of how to read and comprehend any type of reading material.

**RETAILING SMARTS 1 241CE
Get to Know Your Customers
0 UNITS**

This short-term vocational education course is designed to provide new and incumbent workers the methods and skills in getting to know their customer. The curriculum is modifiable for the LEP students. The topics covered but are not limited to: greeting customers in a winning way, building relationships, and determining a customer's needs. After completing this course the student has an option to continue their education or become gainfully employed.

RETAILING SMARTS 2 237CE
Strategies in Meeting your Customers Needs
0 UNITS

This short-term vocational education course is designed to provide new and incumbent workers with the strategies required in understanding their customers or client's needs. The curriculum is modifiable for the LEP student. The topics covered but are not limited to making shopping an enjoyable experience, accommodating customers with disabilities, in-store and phone customers, keeping commitments to your customer, and special orders.

RETAILING SMARTS 4 235CE
Going the Extra Mile
0 UNITS

This short-term customer service workshop is designed to provide new and incumbent workers with the strategies required in going the extra mile for a customer. The curriculum is modifiable for the LEP student and designed for incumbent workers and/or new employees. The topics covered but are not limited to: customer follow-up, artfully using business cards, business card etiquette, and personal services. After completion of this workshop the attendee will have two options 1) continue their education 2) become gainfully employed.

RETAILING SMARTS 5 234CE
Explaining Features and Benefits
0 UNITS

This short-term vocational education course is designed to provide new and incumbent workers to explain features and benefits required by customers. The curriculum is modifiable for the LEP students. The topics covered but are not limited to learning about the products you sell, identifying product features and demonstrating product features. After completing this course the student has an option to continue their education or become gratefully employed.

RETAILING SMARTS 6 231CE
Building Sales
0 UNITS

This short-term vocational education course is designed to provide new and incumbent workers in building sales required in getting to know their customer or client. The curriculum is modifiable for the LEP students. The topics covered but are not limited to suggesting additional merchandise, creating special promotions, and taking the guesswork out of gift giving. After completing this course the student has an option to continue their education or become gainfully employed.

RETAILING SMARTS 7 232CE
Closing The Sale
0 UNITS

This short-term vocational education course is designed to provide new and incumbent workers the skills and strategies in making a sale. The curriculum is modifiable for the LEP students. The topics covered but are not limited to recognizing buying signals, asking for the sale and suggesting helpful add-ons.

RETAILING SMARTS 8 233CE
Completing the Sales Transaction
0 UNITS

This short-term vocational education course is designed to provide new and incumbent workers to complete the sales transactions. The curriculum is modifiable for the LEP students. The topics covered but are not limited in accepting checks and credit cards, and completing the paperwork. After completing this course the student has an option to continue their education or become gratefully employed.

STRATEGIES IN ADAPTING TO YOUR CUSTOMER 24CE
0 UNITS

This short-term vocational education course is designed to provide new and incumbent workers with the strategies required in getting to know their customer or client. The curriculum is modifiable for the LEP student. The topics covered but are not limited to learning how to greet customers, building relationships, determining a customer's needs. This course can be offered as a stand-alone course or coupled within the eight modules that are related to this material. After completing this course the student has an option to continue taking classes in their field of choice, or become gainfully employed.

BLUEPRINT FOR CUSTOMER SERVICE 239CE
0 UNITS

This accelerated non-credit course is designed to provide students with the necessary tools and skills in order for them to create a "blueprint" for themselves with respect to the workplace. The topics covered include, but are not limited to, self-discovery, time management, job market realities, workplace skills (in-depth), effective communication, contacting employers, preparing for the interview, getting hired, and keeping your job. Each week there will be two topics covered.

BLUEPRINT FOR WORKPLACE SUCCESS 240CE
0 UNITS

This accelerated non-credit course is designed to provide students with the necessary tools and skills in order for them to create a "blueprint" for themselves with respect to the workplace. The topics covered include, but are not limited to, self-discovery, time management, job market realities, workplace skills (in-depth), effective communication, contacting employers, preparing for the interview, getting hired, and keeping your job. Each week there will be two topics covered.

30 WAYS TO SHINE AS A NEW EMPLOYEE 230 CE
0 UNITS

onal education course is designed to provide new and incumbent workers "30 Ways to Shine as a New Employee" and increase their level of customer service and colleague relations. The curriculum is modifiable for the LEP student. The topics covered but are not limited to new beginners, understanding the workplace culture and dealing with change. After completing this course the student has an option to continue their education or become gainfully employed.

JOB CLUB 236CE
0 UNITS

his curriculum is an educational designed to provide prospective employees with a support system that will assist them in preparation for the workforce. The curriculum is modifiable for the LEP students. The topics covered but are not limited to: job search planning and job market research. After completing this course the student has an option to continue their education or become gainfully employed.

WORKPLACE COMPUTING FOR LIMITED ENGLISH POPULATIONS 003CE
0 UNITS

Fundamentals of computer hardware, software, and the internet for computer novices at the work place, introducing basic computer components and functions including hardware, operating systems, software applications, (e.g. word processing, spreadsheets, email) and web browsers to access information on the world wide web. The focus of this course is to prepare limited English proficient students to be competitive in securing employment, as well as retaining a job once they have acquired a job.

BASIC SKILLS**006CE****Review of Basic English****0 UNITS**

In this course, LEP students will review, grammar, reading, comprehension, literacy responses, writing skills and application.

BASIC SKILLS 007CE Review of Basic Math**0 UNITS**

In this course, students will review basic math operations, number sense, functions and applications, measurements, and geometry, and algebra. This course is modifiable for LEP students.

Career Progression: Effective Management in the Workplace**Course Number: 168CE Course Hours: 36 Hours**

You will build a range of skills essential to effective management, including planning and organizing, managing time and resources, leading and hiring, giving direction, overseeing operations, and resolving employee issues and problems. You will receive practice in each skill set through worksheets and exercises based on real-life situations in today's workplace.

Cultural Awareness in the Workplace**Course Number: 201 CE Course Hours: 18 hours**

You will learn how to improve your business interactions and workplace operations by becoming more aware of different mentalities, behaviors and customs. You will get practice improving communications and building relations through interactive and small-group exercises.

Career Progression: Applying Critical Thinking in the Workplace**Course Number: 169 CE Course Hours: 36 Hours**

In this open-entry/open-exit course, you will improve critical thinking skills and analytical ability through exercises targeting different skill sets, such as considering options, making assumptions, reaching conclusions and assessing solutions. The in-class exercises, utilizing both scenarios and visuals, are designed to give you hands-on practice in hypothetical and real workplace situations.

Cultivating Study Habits for LEP Students**Course Number: 071 CE Course Hours: 72 Hours**

This non credit open entry/exit course will introduce students to proper and effective study habits. Students will develop the expertise and proficiency which will enable them to be master's of their study time. This course is designed for high-level ESL students who are ready to transfer to vocational education departments on campus in pursuit of their educational goals. It is also for those who need a review of what it means to be a successful student. At the end of the course you will be prepared for academic coursework and have the confidence to succeed in any college level course.

Workplace Communication: Leadership Skills and Team Building**Course Number: 092 CE Course Hours: 54 Hours**

This course will introduce you to the skills sets that everyone needs in order to be self-directed. You can be a powerful agent for change, an influencer during the adoption of a new initiative, or a model of productivity and commitment.

Workplace Communication: Team Dynamics**Course Number: 093 CE Course Hours: 54 Hours**

This open-entry/exit course is designed to reinforce the importance of communication in the workplace. The topics covered include but are not limited to: project communication, expectations, closeout reporting and easy templates. The curriculum is modifiable for incumbent workers and dislocated workers seeking employment.

Retailing Smarts: Customer Service and Sales**Course Number: 094 CE Course Hours: 90**

This course is designed to introduce prospective workers to the field of retail and/or reinforce skills and strategies necessary for achieving customer satisfaction by incumbent workers in the industry. The curriculum is provided by the National Retail Federation (NRF). After completing the training, you have the option to take an online exam provided by the NRF, upon a passing score, students will receive a Certification in Customer Service and Sales which is recognized nationally.

- Theater
- Paralegal
- X-Ray Tech
- Dental Tech
- Information Tech
- Law Enforcement
- Cinema/Television
- Registered Nursing

Vermont/Santa Monica Redline Stop

Enroll Now!

LOS ANGELES CITY COLLEGE
855 NORTH VERMONT AVENUE • LOS ANGELES, CA. 90029
www.lacitycollege.edu
888.953.LACC

POLICIES: ACADEMIC, STUDENT, and GENERAL



STUDENT RECORDS & DIRECTORY INFORMATION

The Los Angeles Community College District, in compliance with Federal and State law, has established policies and procedures governing student records and the control of personally identifiable information. The LACCD recognizes that student records are a confidential matter between the individual student and the College. At the same time the LACCD has a responsibility to fulfill public information needs (i.e., information about students participating in athletics, announcement of scholarships and awards).

To meet this responsibility the LACCD may release Directory Information unless the student states in writing not to release it. The responsibility for carrying out these provisions is charged to the College Records Officer, designated by the College President. The Records Officer may be contacted through the Office of Admissions. Copies of Federal and State laws and District policies and procedures are maintained by the College Records Officer and are available for inspection and inquiry.

All student records maintained by the various offices and departments of the College, other than those specifically exempted by law, are open to inspection by the student concerned. The student may challenge the accuracy and appropriateness of the records in writing to the College Records Officer. A student has the right to receive a copy of his or her record, at a cost not to exceed the cost of reproduction. (Requests for transcripts, as distinct from "student records," should be made directly to the Office of Admissions.)

Directory Information includes the student's name, the city of residence, participation in officially recognized activities and sports, weight and height of members of athletic teams, dates of attendance, degrees and awards received, and the most recent previous educational agency or institution attended by the student. Directory Information about any student currently attending the College may be released or withheld at the discretion of the College Records Officer.

Los Angeles City College will release no student records, other than Directory Information, without the written consent of the student concerned except as authorized by law. A log of persons and organizations requesting or receiving student record information is maintained by the College Records Officer. The log is open to inspection only to the student and the community college official or his or her designee responsible for the maintenance of student records. No Directory Information will be released regarding any student who has notified the College Records Officer in writing that the College shall not release such information.

ACADEMIC RENEWAL

(See an Academic Counselor for advisement)

Students may submit a petition to the Office of Admissions and Records to have their academic record reviewed for Academic Renewal action of substandard academic performance under the following conditions:

1. Students must have achieved a grade-point-average of 2.5 in their last 15 semester units, or 2.0 in their last 30 semester units completed at any accredited college or university, and
2. At least two calendar years must have elapsed from the time the course work to be removed was completed.

If the student meets the above conditions, the College shall grant academic renewal, consisting of:

1. Eliminating from consideration in the cumulative grade-point-average up to 18 semester units of course work, and
2. Annotating the student academic record indicating where Academic Renewal action has removed courses.

Academic renewal actions are irreversible. Students should meet with a College Counselor before taking such an action.

TRANSCRIPTS/VERIFICATIONS

Upon written request, a copy of students' academic records (transcripts) shall be forwarded by United States mail to the students or their designated addresses.

Students and former students shall be entitled to two free copies of their transcripts or to two free verifications of enrollment. Additional copies shall be made available to students, or to designated addressees identified by students, at a cost of \$3.00 each. Students may request special processing to expedite their request for an additional fee of \$10.00 per request.

A student's transcript may be withheld if a hold has been placed on his or her record due to equipment, books, uniforms, or similar items that the student has not returned to the College or in the instance of any unpaid fees or charges due to LACC or to any LACCD college. The transcript may be withheld until the student discharges these obligations.

Requests for transcripts or verifications may be obtained in the Office of Admissions and Records, AD 100.

CONDITIONS OF ENROLLMENT IN LACC CLASSES

Unless specifically exempted by law, every course for which State aid is claimed is fully open to any person who has been admitted to the College and who meets the appropriate academic prerequisites.

CONCURRENT ENROLLMENT

Concurrent enrollment in more than one section of the same course during a semester is not permitted, except for certain Physical Education classes on a limited basis. Concurrent enrollment in courses which are cross-referenced to each other is not permitted. Violation of this regulation will result in exclusion from class and denial of course credit in both courses.

Enrolling in classes scheduled or conducted during overlapping times is not permitted. In addition to exclusion from both classes and denial of credits, violators will be subject to disciplinary action. (See "Standards of Student Conduct," elsewhere in this catalog.)

Students may be permitted to audit a class under the following conditions:

1. Payment of a fee of \$15 per unit. Fees are not refundable and they are not covered by a fee waiver. Students enrolled in classes to receive credit for ten or more semester units shall not be charged a fee to audit three or fewer semester units per semester. This fee structure is subject to change.
2. Students auditing a course shall not be permitted to change their enrollment in that course to receive credit for the course.
3. Priority in class enrollment shall be given to students wanting to take the course for credit.
4. Permission to enroll in a class on an audit basis is at the instructor's discretion.
5. Participation in class activities by student auditors will be solely at the discretion of the instructor, who may provide a written statement of how much participation is allowed beyond observation.
6. Students must be added as an auditor by the last day of the term to add classes.

Maximum and minimum unit requirements may apply, as follows:

The maximum study load is 18 units during a regular semester, 12 units during Summer Session and 7 units during a Winter Intersession. The class load for students in the Fall or Spring semester is from 12-18 units for full-time students. A college program of 15 units is equal to at least a 50-hour work week. Students who want to take 19 or more units must obtain approval from a College Counselor.

Those students who will be employed while attending LACC should consider reducing their programs accordingly. Los Angeles City College suggests that those students who are employed full-time should enroll in no more than one or two classes (nine units maximum during the Fall or Spring semester; three units maximum during the Summer Session).

Los Angeles City College defines a “full-time student” as one who is enrolled in 12 or more graded units. Los Angeles City College defines a “part-time student” as one who is enrolled in 6-11 graded units.

ATTENDANCE

Only students who have been admitted to Los Angeles City College and are in approved active status may attend classes. Students should attend every meeting of all classes for which they register. To avoid being excluded from class, students should contact the instructor when they are absent for emergency reasons.

IMPORTANT: Students who are preregistered and miss the first class meeting may lose their right to a place in the class, but the instructor may consider special circumstances. Whenever students are absent more hours than the number of hours the class meets per week, the instructor may exclude them from class. In addition, the instructor will consider whether there are mitigating circumstances which may justify the absences. If the instructor determines that such circumstances do not exist, the instructor may exclude a student from the class.

To avoid being dropped from class, students should contact the instructor when they are absent for emergency reasons. Students are responsible for officially dropping a class that they stop attending. (See “Adding and Dropping” elsewhere in this catalog.)

INSTRUCTOR NOTIFICATION POLICY

Students should notify the instructor regarding absences by United States mail or by placing a notice in the “Student to Faculty Box,” located at the Campus Mail room. Students also may inform the instructor regarding their absences upon return to the class.

ATTENDANCE DEFINITIONS

“Attendance” means attendance in at least one semester each calendar year. Los Angeles City College defines continuous attendance for the California community colleges as attendance in one semester during the calendar year before the current semester of enrollment. (Two semesters need not be consecutive, as long as they are in the same calendar year.) Attendance means enrollment and completion of graded academic course work. (CR, NCR, Inc and W are acceptable.) Summer is not included in continuous attendance. Reference: California Code of Regulations, Title 5, Section 40401.

GRADES & GRADING POLICIES

Only the symbols in the grading scale given in this section will be used to grade all courses offered in fulfillment of the requirements for an Associate degree or certificate. Grades will be averaged based on the point equivalencies to set a student’s grade-point-average, using the following evaluative symbols:

The following non-evaluative symbols may be entered on the student’s record:

GRADE SYMBOL	DEFINITION	POINTS
A	Excellent	4
B	Good	3
C	Satisfactory	2
D	Passing; less than satisfactory	1
F	Failing	0
P	Pass (at least equivalent to a “C” grade or better;	
NP	Equal to “D” or “F” grade; units awarded are not counted in GPA	

Incomplete academic work for unforeseeable emergency and justifiable reasons at the end of the term may result in an “I” symbol being entered in a student record. The condition for removal of the “I” shall be stated by the instructor in a written record, which shall contain the conditions for removal of the “I” and the grade assigned in lieu of its removal. This record shall be given to the student, with a copy on file in the College Office of Admissions until the “I” is made up or the time limit has passed. The “I” symbol shall not be used in calculating units attempted nor for grade points. The “I” must be made up no later than one year following the end of the term in which it was assigned. The student may petition for a time extension due to unusual circumstances.

Courses in which the student has received an Incomplete may not be repeated unless the “I” is removed and has been replaced by a grade. This does not apply to courses which are repeatable for additional credit. Petitions are available in the Admissions office.

The “IP” symbol shall be used only in those courses which extend beyond the normal end of an academic term. “IP” indicates that work is in progress, but that the assignment of a substantive grade must await its completion. The “IP” symbol shall remain on the student’s permanent record in order to satisfy enrollment documentation. The appropriate evaluative grade and unit credit shall be assigned and appear on the student’s record for the term in which the required work of the course is completed. The “IP” shall not be used in calculating grade-point-averages.

If a student enrolled in an open-entry, open-exit course is assigned an “IP” at the end of an attendance period and does not complete the course during the subsequent attendance period, the appropriate faculty will assign an evaluative symbol (grade) as specified above to be recorded on the student’s permanent record for the course.

The “RD” symbol shall be used when the instructor has temporarily not submitted the student’s assigned grade. Students receiving “RD” grades should contact their instructor immediately.

Withdrawal from a class or classes is authorized from the 4th week (or 30% of the time the class meets) through the last day of the 12th week of instruction (or 75% of the time the class is scheduled to meet, whichever is less). No notation (“W” or other) shall be made on the record of a student who withdraws during the first four weeks, or 30% of the time the class is scheduled, whichever is less.

Withdrawal between the end of the 4th week (or 30% of the time the class is scheduled to meet, whichever is less) and the last day of the 14th week of instruction (or 75% of the time the class is scheduled to meet, whichever

is less) shall be authorized after informing the appropriate faculty. A student who remains in class beyond the 12th week (or 75% of the time the class is scheduled, whichever is less) shall be given a grade other than a "W," except in cases of extenuating circumstances.

After the last day of the 12th week (or 75% of the time the class is scheduled, whichever is less), the student may petition to withdraw from class by demonstrating extenuating circumstances. Students may obtain a petition in the Admissions Office. Extenuating circumstances are verified cases of accidents, illness, or other circumstances beyond the control of the student. Withdrawal after the end of the 12th week (or 75% of the time the class is scheduled, whichever is less) which has been authorized in extenuating circumstances shall be recorded as "W."

The "W" shall not be used in calculating units attempted nor for the student's grade point average. "W" will be used as a factor in progress probation and dismissal.

DEANS' & PRESIDENT'S HONORS

Students with outstanding scholastic achievement are given public recognition through the Los Angeles City College Dean's List. Full-time students (a student enrolled in 12 or more graded units the qualifying semester) must earn a 3.5 or higher GPA. Part-time students (a student enrolled in 6 through 11 graded units) must have completed 12 units and earn a 3.5 or higher GPA in the qualifying semester. Only the grades from courses completed at LACC, during the qualifying semester, will be used in calculating the grade point average (GPA). Grades of "Credit" will not be counted in meeting the unit requirement for the Dean's or President's Honor List.

Students who have appeared on the college's full-time or part-time Dean's Honor list for three (3) consecutive semesters will be placed on the President's Distinguished Honor List. Students on the President's Honor list will receive a lifetime library (limited) privilege card. Students who qualify for the Dean's and President's Honors are automatically placed on the lists. Students who think they qualify for either of these honors can go to the Admissions Office and request an unofficial transcript of their records, or use an electronic kiosk, or access the college's website and print out their transcript. Bring the unofficial transcript to the Office of Student Activities, Clausen Hall 117 for verification.

The Dean's Honor Program is held annually each spring semester to acknowledge the students who earned their honors the prior spring and fall semesters. Certificates commemorating the occasion are presented.

For graduation with honors (Summa Cum Laude, Magna Cum Laude, Cum Laude), see "Graduation With Honors" in the Graduation Requirements section of this catalog.

GRADES & GRADE CHANGES

The Los Angeles Community College Board of Trustees has approved the following grading policies and academic standards as required by California law. Please be aware of these policies and standards as they can have serious consequences if not followed. The Admissions Office and the Counseling Office will be happy to answer any questions you might have regarding these policies and standards.

- Section 76224(a) provides: When grades are given for any course of instruction taught in a community college district, the grade given to each student shall be the grade determined by the instructor of the course, and the determination of the student's grade by the instructor,

in the absence of a mistake, fraud, bad faith, or incompetency, shall be final.

- No grade may be challenged by a student more than one (1) year from the end of the term in which the course was taken, provided that if a college's academic senate has determined that the period of time during which grades may be challenged should be more than one year, such longer period shall apply at that college. (Title 5, CAC, Section 51308)

Students must file petitions in the Admissions Office for any evaluative or non-evaluative grade symbol change. Inquiries regarding results of grade petitions or instructor complaints should first be directed to the faculty member responsible for the course. If resolution is not reached, the inquiry should be directed to the appropriate academic department chairperson and/or area Dean. If resolution is not reached at the departmental or area Dean level, inquiries should be made to the campus Ombudsperson, at (323) 953-4000 ext. 2249.

PASS/NO PASS OPTION (P/NP)

The College President may designate courses wherein all students enrolled in such courses are evaluated on a pass/no pass basis or wherein each student may elect on registration or no later than the end of the first 30% of the term whether the basis of evaluation is to be pass/no pass or a letter grade. These courses are noted elsewhere in this catalog as being eligible for the pass/no pass Option.

1. **Single performance standard.** The pass/no pass grading system shall be used in any course in which there is a single satisfactory standard of performance for which unit credit is assigned. A grade of Pass (P) shall be assigned for meeting that standard, and a grade of No-Pass (NP) shall be assigned for failure to do so.
2. **Acceptance of credits.** All units earned on a pass/no pass basis in accredited California institutions of higher education or equivalent out-of-state institutions shall be counted in satisfaction of community college curriculum requirements.
3. **Recording of grade.** A student who is approved to be evaluated on the pass/no pass basis shall receive both course credit and unit credit upon satisfactory completion of the course. Satisfactory completion for credit is equivalent to the grade of "C" or better. A student who does not perform satisfactorily will be assigned a No-Pass (NP) grade.
4. **Grade point calculation.** Units earned on a pass/no pass basis shall not be used to calculate grade-point-averages. Units attempted for which No-Pass (NP) is recorded shall be considered in probationary and dismissal procedures.
5. **Standards of evaluation.** The student who is enrolled in a course on a pass/no pass basis will be held responsible for all assignments and examinations required in the course and must meet the standards of evaluation which are identical for all students.
6. **Conversion to letter grade.** A student who has received credit for a course taken on a pass/no pass basis may not convert this credit to a letter grade.
7. **Course repetition.** A student who has received a grade of No-Pass (NP) may repeat the course by meeting the requirements set forth by the District Course Repetition to Improve Substandard Grades Policy.

CREDIT/NO-CREDIT COURSES

Credit/No-Credit Courses do not fulfill prerequisites for more advanced courses. The student must meet all class standards. A maximum of 15 units of credit/no-credit grades may be applied toward the Associate Degree. Courses offered on this basis are listed below. NOTE: Please check the appropriate academic department for confirmation. Designated courses are subject to change.

ACCOUNTING

(BUSINESSADMINISTRATION): All courses

ADMINISTRATION OF JUSTICE: All courses except 73 and 80

AFRICAN-AMERICAN STUDIES: All courses

ANTHROPOLOGY: All courses

ARCHITECTURE: 130,131

ART: 101, 102, 103, 105, 107, 109, and 111

ASIAN STUDIES: All courses

ASTRONOMY: 1

BIOLOGY: 1, 3, 23 and 25

BUSINESSADMINISTRATION: All courses

CHICANO STUDIES: All courses

CINEMA: 185

COMPUTER TECHNOLOGY: All courses

CORRECTIONS: All courses

CSIT: All courses

DANCE

EARTH SCIENCES:

All courses, except 185, 285 and 385

ECONOMICS: 1

ELECTRONICS: All courses

ENGINEERING: All courses

ENGLISH: All courses, except 101, 102 and 103

ENVIRONMENTAL STUDIES: All courses

FINANCE: All courses

FOREIGN LANGUAGES: All courses

GEOGRAPHY: All courses

GEOLOGY: All courses

HEALTH All courses

HISTORY: 11, 12 and 13

HUMANITIES: All courses

JOURNALISM: 5, 17, 18 and 19

INTERNATIONAL BUSINESS: All courses

LAW: All courses

LEARNING SKILLS: All courses

LIBRARY SCIENCE 101

MANAGEMENT: All courses

MARKETING: All courses

MATHEMATICS: All courses

METEOROLOGY: All courses

MUSIC: 101, 111, 133, 135, 137, 141, 152, 161, and 181

OCEANOGRAPHY: All courses

OFFICE ADMINISTRATION: All courses

PHILOSOPHY: All courses

PHOTOGRAPHY: All courses

PHYSICAL EDUCATION: 96 through 499

PHYSICAL SCIENCE: 1, and 14

PHYSICS: 11, 12, 14

POLITICAL SCIENCE: 1

PSYCHOLOGY:

1, 2, 3, 12, 13, 14, 18, 21, 24, 32, 41, 43 and 52 and 72

RADIOLOGIC TECHNOLOGY: 160 and 180

REAL ESTATE: All courses

SOCIOLOGY: 1

SPEECH COMMUNICATION: All courses

SUPERVISION: All courses

TELEVISION: 1, 2 and 911

THEATRE ARTS: 200, 271, and 273; Non-Academy Students (100, 243, 300, 315, 413 and 450)

TRANSPORTATION-TRAVEL-TOURISM: All courses

DIRECTED STUDY COURSES

Directed Study courses are offered by several academic and vocational departments. They are designed for students who are capable of independent work and who demonstrate the need or desire for additional study beyond the regular curriculum. Enrollment allows students to pursue activities such as directed field experience, research, or the development of skills and competencies under faculty advisement and supervision. Directed Study courses are available in a wide variety of disciplines. Students wishing to enroll in a Directed Study course should contact the appropriate department chair.

Units are awarded depending upon satisfactory performance and the amount of time committed by the student to the course. Allowable units vary according to discipline and are based on the following formula:

Directed Study 185	(1-unit)	=	48 hours per semester
Directed Study 285	(2-unit)	=	96 hours per semester
Directed Study 385	(3-unit)	=	144 hours per semester

Students should note that there are limitations as to the allowable maximum number of Directed Study units. For all Directed Study Courses transferring to the University of California, the maximum credit allowed is 3 semester units per term or six units total in any and all appropriate subject areas combined. The granting of transfer credit for Directed Study courses is contingent upon review of the course outline by the appropriate UC campus.

It is recommended that students consult with a College Counselor and with the appropriate instructor and/or department chairperson before enrolling in Directed Study courses. Please refer to the current Schedule of Classes for information regarding specific Directed Study classes being offered.

During the first two weeks of the term, available classes are posted by section number in an area near the Office of Admissions in the Administration building. As with other LACC classes, the available classes listed at the Add Card Center are available to add by telephone.

GRADE REPORTS

Any drops or exclusions that occur between the 5th and the 12th week of the Los Angeles Community College District does not mail grades to students. Students may receive information on their grades through the Student Telephone Enrollment Process (STEP). (See elsewhere in this catalog for additional information about STEP.) To receive grade information, follow these procedures:

- Step One: Dial one of the following numbers: (323) 226-1999; (213) 689-8888; (310) 605-0505; (818) 988-2222. STEP's voice response will guide you with each entry. Press * to correct any mistakes.
- Step Two: Press 1 for Los Angeles City College.
- Step Three: Press 1 for Spring, 2 for Summer, or 3 for Fall semester
- Step Four: Enter your social security number without dashes (or student identification if it is different from your social security number)
- Step Five: Enter your Personal Identification Number (PIN).
- Step Six: Press 3 to hear your grades.
- Step Seven: Press 9 to exit the system.

You may obtain a printed copy of your grades from the LACC Admissions Office. This printed copy is not a transcript or a Verification of Enrollment. If you need a transcript or a Verification of Enrollment, you may order it from the Admissions Office. Refer to "Transcripts/Verification" elsewhere in this catalog.

ADDING/DROPPING CLASSES AND COLLEGE WITHDRAWAL

LACC policies regarding adding and dropping classes are listed below. These policies are subject to change. Refer to the current Schedule of Classes for current information.

Only students who have been admitted to the College and are in approved active status may add or attend classes. Registered students who are on a waiting or standby list must obtain permission from the instructor to add the class.

During the first two weeks of the term, available classes are posted by section number in an area near the Office of Admissions in the Administration building. As with other LACC classes, the available classes listed at the Add Center are available to add by telephone.

Students wishing to drop one or more classes must do so through the Office of Admissions by filing a drop card or through the telephone (STEP) or web site.

It is the student's responsibility to drop from class if he or she decides not to attend or stops attending. Students might not be automatically dropped and/or excluded and will be accountable for any fees due.

The following schedule applies to dropping classes.

Any drops or exclusions that occur before the end of the 4th week of the semester (or 30% of the time the class is scheduled to meet) will not be noted on the student records.

the semester (or 75% of the time the class is scheduled, whichever is less) will result in a "W" ("Withdrawal") on the student's record, which will be included in the determination of progress probation.

Drops are not permitted beyond the end of the 12th week. A grade (A, B, C, D, F, P, I, or NP) will be assigned to students who are enrolled past the end of the 12th week even if they stop attending class, except in cases of extenuating circumstances. After the last day to drop students may withdraw from class upon petition demonstrating extenuating circumstances. Petitions may be obtained from the Office of Admissions.

It is recommended that students consult with a College Counselor when withdrawing (dropping all classes). Clearance of the record in courses where equipment has been issued is required when students separate from such classes.

PROBATION & DISMISSAL

The following standards for academic and progress probation shall be applied as required by regulations adopted by the Board of Governors of the California Community Colleges.

A student shall be placed on probation if any one of the following conditions prevail:

Academic Probation: The student has attempted a minimum of 12 semester units of work and has a grade-point-average less than a "C" (2.0).

Progress probation: The student has enrolled in a total of at least 12 semester units and the percentage of all units in which a student has enrolled and for which entries of W (Withdrawal), I (Incomplete), and NP (No Pass) are recorded reaches or exceeds fifty percent (50%).

Transfer student: The student has met the conditions of "Academic Probation" or "Progress Probation," above, at another college within the Los Angeles Community College District.

Units Attempted: "Units Attempted," for purposes of determining probation status only, means all units of credit in the current community college of attendance in which the student is enrolled.

Students shall be subject to dismissal and subsequently be dismissed under the conditions set forth within this section. Dismissal from Los Angeles City College shall disqualify students from admission to any college in the Los Angeles Community College District (LACCD).

Academic Dismissal: Students who are on academic probation shall be subject to dismissal if they have earned a cumulative grade-point-average of less than 2.0 in all units attempted in each of three consecutive semesters.

Students who are on academic probation and who earn a semester grade-point-average of 2.0 or better shall not be dismissed as long as this minimum semester grade-point-average is maintained.

Progress Dismissal: Students who are on progress probation shall be subject to dismissal if the cumulative percentage of units in which they

have been enrolled for which entries of W (Withdrawal), I (Incomplete), and NP (No Pass) are recorded in at least three (3) consecutive semesters reaches or exceeds fifty percent (50%). Students who are on progress probation shall not be dismissed after a semester in which the percentage of units in which they have been enrolled for which entries of W, I and NP are recorded is less than fifty percent (50%).

Students who are subject to dismissal may appeal to the Vice President of Student Services. Dismissal may be postponed and the student continued on probation if the student shows significant improvement in academic achievement but has not been able to achieve a level that would meet the requirements for removal from probation.

Students who have been dismissed may request reinstatement after two (2) semesters have elapsed. They shall submit a written petition requesting readmission to the College in compliance with College procedures. Readmission may be granted, denied, or postponed subject to fulfillment of conditions prescribed by the College. Students must file a petition to return prior to the day for new and returning students to register in person. Refer to the College Calendar in the current Schedule of Classes for effective dates.

COURSE REPETITION

See an Academic Counselor For Advisement

Repetition of courses for which substandard work has not been recorded shall be permitted only upon advance petition of the student and with permission of the College President or designee based on a finding that circumstances exist which justify such repetition. In such repetition under special circumstances, the student's permanent academic record shall be annotated in such a manner that all work remains legible. Grades awarded for repetition under special circumstances shall not be counted in calculating a student's grade-point-average.

Students may petition for approval to repeat courses up to a total of 15 units in which substandard grades (less than "C") were awarded. Students may repeat the same course only once for this purpose. Upon completion of a course repetition, the best grade earned will be computed in the cumulative grade-point-average and the student academic record so annotated.

No specific course or categories of courses shall be exempt from course repetition. This policy is adopted for use in the Los Angeles Community College District only. Other institutions may differ. Students planning to transfer to another college or university should contact that institution regarding its policy.

CREDIT BY EXAMINATION

Some courses in listed in this catalog are eligible for credit by examination.

1. Methods of obtaining credit by examination.
 - a. Achievement of a score of three (3) or higher on an Advanced Placement Examination administered by the College Entrance Board
 - b. Credit by satisfactory completion of an examination administered by the college in lieu of completion of a course listed in the Los Angeles City College Catalog.
 - c. Achievement of a score that qualifies for credit on an examination administered by other agencies approved by Los Angeles City College.

2. Determination of Eligibility to Take College Administered Examinations. Students who qualify:
 - a. Must be currently enrolled in at least six (6) units at Los Angeles City College, in good standing, and with minimum grade point average of "C" (2.0) in any work attempted at Los Angeles City College.
 - b. May petition for credit by examination if they
 - 1) Are eligible to take such course for credit under existing regulations;
 - 2) Have not completed a course or are not in the process of taking a course which is more advanced than the course for which credit is requested.

3. Maximum credit allowable for credit by examination:

The maximum number of credits allowable for credit by examination for the associate degree shall be fifteen (15). Credit by examination transferred from other institutions is counted toward this maximum.

Limitations :

- a. Credits acquired by examination are not applicable to meeting such unit load requirements as Veteran or Social Security benefits.
 - b. Recording of Credit: Students who successfully pass the examination given to fulfill the "credit by examination" option shall have the course posted on their cumulative record indicating "Credit" in the grade column. The number of units of credit recorded for any course may not exceed those listed in the College catalog.
4. Acceptance Towards Residence

Units for which credit is given pursuant to the provisions of this section shall not be counted in determining the twelve units of credit in residence requirement.
 5. Recording of credit:
 - a. If a student passes the examination, the course shall be based on his/her cumulative record indicating "Credit" in the "Grade" column.
 - b. The number of units of credit recorded for any course may not exceed those listed in the Los Angeles City College Catalog.

CREDIT FOR COURSES COMPLETED AT NON-ACCREDITED INSTITUTION

Students transferring from institutions not accredited by the Western Association of Schools and Colleges may, after successful completion of 30 units with a "C" or better grade-point-average, petition for credit in courses which parallel the offerings of the College.

The following exceptions for currently enrolled students may be made to this regulation:

1. Credit for Graduates of Diploma Schools of Nursing. The following amount of credit is authorized for graduates of Diploma Schools of Nursing who enter a Los Angeles Community College District college:
 - A. Thirty semester units of credit will be awarded to graduates of Diploma Schools of Nursing under the following conditions:
 - i. The student presents a valid, current California certificate as a licensed registered nurse to the designated administrative officer;
 - ii. The student has completed at least 12 units of credit at the College to which application is made.
 - B. The work of graduates of Diploma Schools of Nursing outside California will be recognized if the student has a valid, current California license. Credit will be given although the license

was obtained by reciprocity with another state rather than by examination.

- C. Candidates for the Associate of Arts or Associate of Science Degree are exempt from Health Education as a general education requirement. No other general education requirements will be waived.
 - D. The transcript is not to reflect the major field nor should the diploma, where given, indicate Nursing as a major.
2. Credits for Military Service Training Students who are currently serving in or have served in the military service, may, after successful completion of at least one course at a college in the Los Angeles Community College District, request an evaluation of credit earned through military service training schools and/or military occupational specialties for a total of six general elective credits.
 3. Credits for Law Enforcement Academy Training Credit for basic recruit academy training instructional programs in Administration of Justice or other criminal justice occupations shall be granted as follows:
 - A. Credit will be given for training from institutions which meet the standards of training of the California Peace Officers Standards and Training Commission.
 - B. A single block of credit will be given and identified as academy credit.
 - C. One unit of credit may be granted for each 50 hours of training, not to exceed 18 semester units or their equivalent. Credits granted by an institution of higher education for basic recruit academy training, under the above provisions, shall not be identified as equivalent to any required course in the major.
 4. Acceptance Towards Residence Units for which credit is given pursuant to the provisions of this section shall not be counted in determining the twelve units of credit in residence requirement.
 5. Recording of Grade Students who successfully pass the examination given to fulfill the "credit by examination" option shall have the record of such examination entered on their record as "CRX" (Credit by Exam), as provided by the LACCD Grading Symbols and Definitions Policy.

*The exception being foreign languages.

EVALUATION OF FOREIGN AND INTERNATIONAL TRANSCRIPTS

Students who wish to receive course credit for college and university work completed in a foreign country or outside of the United States must have their transcripts evaluated if the transcript is in foreign language.

It is also recommended that course descriptions be submitted along with the evaluated transcript, for courses that the student would like to receive credit. The process for receiving credit for Foreign/International Transcripts is as follows:

1. A petition must be submitted to the Admissions Office in AD-100 to request credit for the courses in question along with the evaluated transcripts. If you don't know where to take your Foreign/International transcripts to be evaluated, the Admissions Office will provide you with a list of LACCD recognized companies that are authorized to evaluate Foreign/International transcripts.

2. It is advisable that you provide the Admissions Office with course descriptions, where possible, of the evaluated course work, or any catalog information that may expedite the evaluation process. Please refer to the university or college the course work was completed, to request course descriptions.
3. After your petition and transcripts have been evaluated, you will be informed of the outcome.

If you do not agree with the outcome of your petition, you may petition the appropriate Department Chair. The decision of the Department Chair is final.

CANCELLATION OF CLASSES

The College reserves the right to discontinue any class with insufficient enrollment.

CLASSROOM CONDUCT

Instructors are responsible for presenting appropriate material in courses, and students are responsible for learning this material. Although it is a student's academic performance that is evaluated in determining grades, student conduct is important in the academic setting. Enrollment in a class may be terminated due to unsatisfactory student conduct, undue disrespect toward an instructor or administrator, or academic dishonesty. Each student is responsible for maintaining standards of academic performance established for each course in which he or she is enrolled.

STANDARDS OF STUDENT CONDUCT

Students enrolling in one of the Los Angeles Community Colleges may rightfully expect that the faculty and administrators will maintain an environment in which there is freedom to learn. This requires that there be appropriate conditions and opportunities in the classroom and on the campus. As members of the College community, students should be encouraged to develop the capacity for critical judgment; to engage in sustained and independent search for truth; and to exercise their rights to free inquiry and free speech in a responsible, nonviolent manner.

Students shall respect and obey civil and criminal law, and shall be subject to legal penalties for violation of laws of the City, County, State, and Nation.

Student conduct must conform to LACCD and Los Angeles City College rules and regulations. Violations of such rules and regulations will subject students to disciplinary action. Such violations, include, but are not limited to, the following:

BOARD RULE 9803.10

Willful disobedience to directions of College officials acting in the performance of their duties.

BOARD RULE 9803.11

Violation of College rules and regulations including those concerning student organizations, the use of College facilities, or the time, place, and manner of public expression or distribution of materials.

BOARD RULE 9803.12

Dishonesty, such as cheating, or knowingly furnishing false information to the College.

BOARD RULE 9803.13

Unauthorized entry to or use of the College facilities.

BOARD RULE 9803.14

Forgery, alteration, or misuse of College documents, records, or identification.

BOARD RULE 9803.15

Obstruction or disruption of classes, administration, disciplinary procedures, or authorized College activities.

BOARD RULE 9803.16

Theft of or Damage to Property. Theft of or damage to property belonging to the College, a member of the College community, or a campus visitor.

BOARD RULE 9803.17

Interference with Peace of College. The malicious or willful disturbance of the peace or quiet of any of the Los Angeles Community Colleges by loud or unusual noise of any threat, challenge to fight, or violation of any rules of conduct as set forth in the LACCD Board Rule regarding “Conduct on Campus.” Any person whose conduct violates this section shall be considered to have interfered with the peaceful conduct of the activities of the College where such acts are committed.

BOARD RULE 9803.18

Assault or Battery. Assault or battery, abuse or any threat of force or violence directed toward any member of the college community or campus visitor engaged in authorized activities.

BOARD RULE 9803.19

Alcohol and Drugs. Any possession of controlled substances which would constitute a violation of Health and Safety Code section 11350 or Business and Professions Code section 4230, any controlled substances the possession of which are prohibited by the same, or any possession or use of alcoholic beverages while on any property owned or used by the District or colleges of the District or while participating in any District or college-sponsored function or field trip. “Controlled substances,” as used in this section, include but are not limited to the following drugs and narcotics: Opiates, opium, and opium derivatives; mescaline; hallucinogenic substances; peyote, marijuana; stimulants, depressants, cocaine.

BOARD RULE 9803.20

Lethal Weapons. Possession, while on a college campus or at a college-sponsored function, of any object that might be used as a lethal weapon is forbidden all persons except sworn peace officers, police officers, and other government employees charged with policing responsibilities.

BOARD RULE 9803.21

Discriminatory Behavior. Behavior while on a college campus or at a college-sponsored function, inconsistent with the District’s nondiscrimination policy, which requires that all programs and activities of the Los Angeles Community College District be operated in a manner which is free of discrimination on the basis of race, color, national origin, ancestry, religion, creed, sex, pregnancy, marital status, sexual orientation, age, handicap, or veterans status.

BOARD RULE 9803.22

Unlawful Assembly. Any assemblage of two or more persons to (1) do an unlawful act, or (2) do a lawful act in a violent, boisterous, or tumultuous manner.

BOARD RULE 9803.23

Conspiring to Perform Illegal Acts. Any agreement between two or more persons to perform illegal acts.

BOARD RULE 9803.24

Threatening Behavior. A direct or implied expression of intent to inflict physical or mental/emotional harm and/or actions, such as stalking, which a reasonable person would perceive as a threat to personal safety or property. Threats may include verbal statements, written statements, telephone threats, or physical threats.

BOARD RULE 9803.25

Disorderly Conduct. Conduct which may be considered disorderly includes: lewd or indecent attire or behavior that disrupts classes or college activities; breach of the peace of the college; aiding or inciting another person to breach the peace of the college premises or functions.

BOARD RULE 9803.26

Theft or Abuse of Computer Resources. Theft or abuse of computer resources including but not limited to: (a) Unauthorized entry into a file to use, read, or change the contents, or for any other purpose. (b) Unauthorized transfer of a file. (c) Unauthorized use of another individual’s identification and password. (d) Use of computing facilities to interfere with the work of a student, faculty member, or college official, or to alter college or district records. (e) Use of unlicensed software. (f) Unauthorized copying of software. (g) Use of computing facilities to access, send or engage in messages which are obscene, threatening, defamatory, present a clear and present danger, violate a lawful regulation and/or substantially disrupt the orderly operation of a college campus. (h) Use of computing facilities to interfere with the regular operation of the college or district computing system.

BOARD RULE 2803.27

Performance of an Illegal Act. Conduct while present on a college campus or at a location operated and/or controlled by the District or at a District-sponsored event, which is prohibited by local, State, or federal law.

BOARD RULE 9804

Interference with Classes. Every person who, by physical force, willfully obstructs or attempts to obstruct, or attempts to obstruct, any student or teacher seeking to attend or instruct classes at any of the campuses or facilities owned, controlled, or administered by the Board of Trustees of the Los Angeles Community College District, is punishable by a fine not exceeding five hundred dollars (\$500) or imprisonment in a county jail not to exceed one (1) year, or by both such fine and imprisonment. As used in this section, “physical force” includes, but is not limited to, use of one’s person, individually or in or concert with others, to impede access to or movement within which the premises are devoted.

BOARD RULE 9805

Interference with Performance of Duties by Employees. Action to cause or attempt to cause, any employee of the Los Angeles Community Colleges to do or refrain from doing, any act in the performance of his/her duties by means of a threat to inflict any injury upon any person or property, is guilty of a public offense.

BOARD RULE 9805.10

Assault or abuse of an Instructor. Assault or abuse of any instructor employed by the District in the presence or hearing of a community

college student or in the presence of other community college personnel or students and at a place which is on District premises or public sidewalks, streets, or other public ways adjacent to school premises, or at some other place where the instructor is required to be in connection with assigned college activities.

BOARD RULE 9806

Unsafe Conduct. Conduct which poses a threat of harm to the with a Health Services Program (e.g., Nursing, Dental Hygiene, etc.); failure to follow safety direction of District and/or college staff; willful disregard to safety rules as adopted by the District and/or college; negligent behavior which creates an unsafe environment.

Unauthorized distribution of copyrighted material, including unauthorized peer-to-peer file sharing, may subject students to civil and criminal liability. Civil liability for copyright infringement may include payment of monetary damages to the copyright owner. Criminal penalties for copyright infringement may include fines up to \$250,000 and imprisonment up to ten years. Students who violate the District's computing facilities usage policy (LACCD Administrative Regulation B-28) may also be subject to college disciplinary action, including, but not limited to, suspension or expulsion.

STUDENT DISCIPLINE PROCEDURES

Community college districts are required by law to adopt standards of student conduct along with applicable penalties for violation (Education Code Section 66300). The Los Angeles Community College District has complied with this requirement by adopting Board Rules 9803 and 9804-9806, Standards of Student Conduct .

The LACCD has adopted Board Rule 91101, "Student Discipline Procedures," to provide uniform procedures to assure due process when a student is charged with a violation of the Standards of Student Conduct. All proceedings held in accordance with these procedures shall relate specifically to an alleged violation of the established Standards of Student Conduct. These provisions do not apply to grievance procedures, student organization councils and courts, or residence determination and other academic and legal requirements for admission and retention. Disciplinary measures may be taken by the College independently of any charges filed through civil or criminal authorities, or both.

Copies of the Student Discipline Procedures are available in the Office of Vice President of Student Services.

STUDENT GRIEVANCE PROCEDURES- OMBUDSPERSON ADMINISTRATIVE REGULATION E-55

Information about the grievance procedures and a copy of the regulation are available to grievant(s) and/or respondent(s) upon request from the Ombudsperson room 208C of the Caesar Chavez Administration Building. The purpose of this regulation is to provide a prompt and equitable means for resolving student(s) grievances. In the pursuit of academic goals, the student should be free of unfair or improper action by any member of the academic community.

The grievance procedure may be initiated by a student, or group of students who reasonably believe he/she/they have been subjected to unjust action or denied rights that adversely affect his/her/their status, rights, or privileges as a student. It is the responsibility of the student(s) to submit proof of alleged unfair or improper action.

The role of the Ombudsperson is that of a facilitator of the grievance process, and not that of an advocate for either the grievant(s) or respondent(s). During the informal resolution stage of the grievance process, the ombudsperson will facilitate informal meetings and discussions that may lead to a resolution of the grievance.

If the matter cannot be resolved informally, the student may request a formal grievance hearing. Grievances pertaining to grades are subject to the California Education Code, Section 76224(a) which states: "When grades are given for any course of instruction taught in a community college district, the grade given to each student shall be the grade determined by the instructor of the course and the determination of the student's grade by the instructor, in the absence of mistake, fraud, bad faith, or incompetency, shall be final."

This grievance procedure does not apply to the challenge process for prerequisites, co-requisites, advisories and limitations on enrollment; alleged violations of sexual harassment; actions involving student discipline; alleged discrimination on the basis of the ethnic group identification, religion, age, sex, color, sexual orientation, physical or mental disability; or an appeal for residency decision; or the eligibility, disqualification or reinstatement of Financial Aid. The appeal procedure regarding Financial Aid may be obtained in the Financial Aid Office. Additional information regarding discrimination and sexual harassment procedures and policies are listed in the Schedule of Classes and the College Catalog. Procedure may be obtained from the Ombudsperson, located in AD 208C. For assistance, call (323) 953-4000 ext. 2249.

OPEN ENROLLMENT

The policy of the Los Angeles Community College District is that, unless specifically exempted by statute or regulation, every course, course selection, or class offered and maintained by the District and reported for state aid shall be fully open to enrollment and participation by any person who has been admitted to Los Angeles City College and who meets the prerequisites established according to the regulations contained in California Code of Regulations Title 5 §§55200-55202.

DRUG-FREE CAMPUS

Los Angeles City College adheres to, supports, and is in full compliance with requirements that maintain our college as a drug-free institution of higher education. The LACCD Board of Trustees has adopted the following standards of conduct:

Students and employees are prohibited from unlawfully possessing, using or distributing illicit drugs and alcohol on district premises, in District vehicles, or as part of any activity of the Los Angeles Community College District.

The LACCD Board of Trustees has adopted Rule 9803.19, which prohibits: Any possession of controlled substances which would constitute a violation of Health and Safety Code section 11350 or Business and Professions Code section 4230, any use of controlled substances, the possession of which is prohibited by the same or any possession or use of alcoholic beverages

while on any property owned or used by the District or colleges of the District. “Controlled substances,” as used in this section, include, but are not limited to the following drugs and narcotics: opiates, opium and opium derivatives, mescaline, hallucinogenic substances, peyote, marijuana, stimulants, depressants, cocaine.

The LACCD Board of Trustees policy on the Drug-Free Workplace restates these prohibitions.

Legal Sanctions

Federal laws regarding alcohol and illicit drugs allow for fines and/or imprisonment. Other legal problems include the loss of driver’s license and limitations of career choices.

Health Risks

Health risks associated with the abuse of controlled substances include malnutrition, damage to various organs, hangovers, blackouts, general fatigue, impaired learning, dependency, disability, and death. Both drugs and alcohol may be damaging to the development of an unborn fetus.

Other Risks

Personal problems include diminished self-esteem, depression, alienation from reality, and suicide. Social problems include loss of friends, academic standing and co- and extra- curricular opportunities, alienation from and abuse of family members, and chronic conflict with authority. Economic problems include loss of job, financial aid eligibility, homes, savings, and other assets.

Counseling, Treatment and Rehabilitation

Students should contact the LACC Counseling Office for assistance and referrals.

Disciplinary Action

Violation of the above Board Rules shall result in student discipline, imposed in accordance with the Student or termination of financial aid; suspension; withdrawal of consent to remain on campus; expulsion subject to reconsideration; and permanent expulsion. Furthermore, institutional policies and practices may impose disciplinary sanctions on students and employees consistent with local, state, and Federal law, up to and including expulsion, termination of employment, and referral for prosecution for violations of the standard of conduct.

The Los Angeles Community College District is committed to drug-free and alcohol-free campuses. We ask you to share in this commitment and dedication.

EDUCATIONAL ENVIRONMENT POLICY

Due to requirements set forth by the Occupational Safety and Health Administration, proper attire, including shoes, eye ware, and other articles, should be worn during all class hours.

FAMILY EDUCATION RIGHTS & PRIVACY ACT

See Student Records and Directory Information, elsewhere in this catalog.

HEALTH FEE WAIVERS (STUDENT)

LACCD policy exempts the following students from paying the student health fee: a) students who depend exclusively on prayer for healing in accordance with the teaching of a bonafide religious sect; c) students attending classes under an approved apprenticeship training programs; d) non-credit education students; e) students enrolled exclusively at District sites where health services are not provided; f) students enrolled exclusively through Instructional Television or distance education classes; g) students enrolled exclusively through contract education. Students exempted under the provisions of a), c) and d) above are eligible to receive the services of the college health program; all other exempted students are not eligible to receive the services of the college health program.

SEX OFFENDER REGISTRATION

California law requires that certain statutorily defined sex offenders notify community college law enforcement officials that they are present on campus in specific capacities. If you fall into this category, you must register with the College’s Sheriff’s Department Office.

SMOKING POLICY

Smoking is not permitted in any classroom or other enclosed facility that any student is required to occupy or which is customarily occupied by students, faculty, staff, and/or administrator.

WORKFORCE DIVERSITY

The policy of the Los Angeles Community College District is to implement affirmatively equal opportunity to all qualified employees and applicants for employment without regard to race, color, national origin, ancestry, religion, creed, sex, age, disability, marital status, sexual orientation, or veteran status. Positive action will be taken to ensure that this policy is followed in all personnel practices, including recruitment, hiring, placement, upgrading, transfer, demotion, treatment during employment, rate of pay or other forms of compensation, selection for training, layoff, or termination. An Affirmative Action Program will be maintained in accordance with Board Rule 101301.

Inquiries regarding Workforce Diversity at Los Angeles City College should be directed to the Associate Vice President, Administrative Services responsible for Human Resources.

ADDITIONAL POLICY INFORMATION SECTIONS

Please see Table of Contents:
 Equal-Opportunity Policy
 Compliance Procedure
 Sexual Harassment Policy
 Limited English Proficiency

SERVICES & PROGRAMS

ADMISSIONS & RECORDS

Cesar Chavez Administration Building 100 • (323) 953-4000 ext. 2104

<http://www.lacitycollege.edu/citymain/admissions.html>

For information, see the catalog section on Admissions, page 6.

ASSESSMENT

Appointment Window: Cesar Chavez Administration Building, Room 103. Assessment Center: Learning Resource Center•
(323) 953-4000 ext. 2264

<http://www.lacitycollege.edu/services/matriculation/>

For information, see the catalog section on Admissions, page 7

ASSOCIATED STUDENT ORGANIZATION

Learning Resource Center • (323) 953-4000 ext. 2475

<http://aso.lacitycollege.edu/>

The LACC Associated Student Organization (ASO) is the officially designated student organization that represents students' needs and concerns. The ASO is a significant component of LACC's shared governance process. The governing body of the ASO is the Student Senate, composed of officers elected annually by the student body at large, following requirements of LACCD Administrative Regulation E-22.

LACC students are encouraged to join the ASO by paying the ASO fee of \$7.00 per semester. The membership benefits include participation in student government, preferred parking, \$70 book grants (limited number to qualified applicants), free copier services (weekly limit), free scantrons and bluebooks (weekly limit), discounted local faxing, free admission to ASO supported cultural and social events, discount tickets to theaters and local amusement parks, and much more.

The ASO represents students on college, district and state-wide issues. It provides students with leadership opportunities through involvement on the Student Senate and Club Council, and by appointment to various LACC, ASO, regional and state committees. It provides funding support for a variety of campus activities - Dean's Honor Ceremony, Commencement, Welcome Days, Health Fair, English Writing Contest, Forensics Team, Latino Heritage Festival, Foreign Language Day, African-American History Month, blood drives, social events, speakers, and other events.

Student clubs provide a rich and exciting multi-cultural dimension to college life. Any ASO member can start a club—it just takes eight ASO members who share an interest and a faculty advisor—to be chartered by the ASO. Information on joining or starting a club is available in the ASO Services Office. All student clubs must be chartered by the ASO in order to be recognized and officially function on campus.

The Student Senate is composed of the elected, or appointed, student leaders. It meets regularly, with agendas posted in advance in accordance with the Brown Act. It is composed of the President, Executive Vice President, Vice President of Finance, Vice President of Clubs, and 16 Senators. The Associate Dean of Student Life serves as the ASO's advisor. Qualifications to hold student government office, as stated in E-22, include maintaining a minimum unit enrollment and GPA, as well as limits to the number of units completed and semesters holding office.

More information on student government, joining and/or starting a club, holding an activity, eligibility for office, and the many benefits offered, is available in the ASO Services Office in the Learning Resource Center, or by calling (323) 953-4000 extension 2475. All students are encouraged to get involved and get more out of college.

Student Trustee

One student is elected, from all nine colleges within the LACCD, to represent all of the District's students on the Board of Trustees. The Student Trustee sits on the Board, attends meetings, and has an advisory vote. There is an annual election, held in conjunction with the Associated Student Organization election, whereby each student in the District has an opportunity to cast a vote to select the Trustee. LACCD Board rule 2100 details the process for selection and the qualifications for candidacy and insures an equal opportunity for any student from any LACCD campus to seek the position of Student Trustee.

In accordance with existing law, candidates for Student Trustee must:

1. Be currently enrolled at an LACCD college.
2. Be enrolled in a minimum of six (6) units.
3. Maintain enrollment in a minimum of six (6) units through the one-year term of office.
4. Have completed a minimum of 12 units and no more than 80 transferable units.
5. Have and maintain a minimum 2.0 GPA.

BOOKSTORE

Cub Center • (323) 953-4000 ext. 2140

<http://www.lacitycollege.edu/resource/bookstore/>

Hours posted outside store. (Normal Business Hours are M-Th, 7:30am to 7:00 pm Friday 7:30 am to 3:00pm)

The Los Angeles City College Bookstore offers a wide variety of textbooks, supplies and materials that help LACC students succeed in their classes. Faculty provide information to the Bookstore concerning textbooks, supplies and material needs for courses. The bookstore provides these items for purchase by LACC students. In addition, there is the opportunity for the students to sell authorized textbooks back to the bookstore during the last week of each major term and other posted dates.

—Please see cashiers for refund policy and more information—

REFUNDS

Cash register receipt MUST accompany all refunds and exchanges
— NO EXCEPTIONS.

TEXTBOOKS

Required textbooks are arranged alphabetically by subject within their respective departments and numerically by course number. The instructors name will be listed under the book. Used books, if available are on the shelves with the new books. They are clearly marked USED. You should not purchase your textbooks until you are officially enrolled.

Full refunds on textbooks will be allowed during the first 10 school days of the Fall and Spring Semesters and the first 5 days of the Summer, Winter and short-term classes (5 weeks or longer). [see requirements below]. Refunds for books purchased for 8-day courses or courses shorter than 5 weeks will only be allowed during the first day of class.

Refunds for textbooks purchased after the first 10 school days of the Fall and Spring semesters and the first 5 days of the Summer, Winter or short-term classes MUST be made within 24 hours of purchase and will only be allowed if the book is wrong or defective.

NO Refunds or Exchanges will be granted on books during the Final Examination period (i.e. last ten days) of any semester or session.

New Books: Must be returned in same condition as when purchased, free of markings, underlining, soil marks or erasures. Otherwise, the book will be classified as "USED" and refundable at a maximum of 50% of the purchase price. Final determination will be made by Bookstore Management. Water damaged books will not be accepted.

Computer Software: May not be refunded if the package is open. This includes textbooks with software if the shrink-wrap has been opened.

Special Orders: Not eligible for refund.

Shrinkwrapped Textbooks : Packages without software may be refunded if all items in the bundle are in new, sellable condition (to be determined by Bookstore staff). A \$5.00 restocking fee will be charged.

Packages that include cd's, computer disks, cassettes or supplemental booklets etc. must be returned in original, UNOPENED packaging for a refund. Otherwise, they do not qualify for a refund.

SUPPLIES

All clothing and non-textbook items are refundable only if they are in their original package, in new sellable condition, unworn, accompanied by the original sales receipt and returned within 24 hours of purchase.

Cassette tapes, computer disks, paperback books, magazines, catalogs, dictionaries, reference books, dental tools, dissecting kits, compact disks, video tapes, calculators and related items are NOT returnable. Swimwear, goggles, lab glasses, lab smocks and socks are NOT returnable as governed by the California State Health Laws.

CHECK PURCHASING POLICY

Current LACC (or other LACCD campus) Student Registration Fee Receipt or current Associated Student Organization Card AND Valid California I.D. or Drivers License are REQUIRED to pay by check.

Checks must be bank printed and written for the amount of purchase only. No temporary or third party checks are accepted.

There is a 30-day waiting period for a cash refund on merchandise purchased by check. Merchandise must be returned by return deadline to qualify. A credit slip will be issued and a return date given to pick up refund (15 days from date of purchase). If upon return the check has cleared the district bank (tangible proof required) or the canceled check is presented (both sides) cash will be refunded at time of return.

NOTE- AFTER JULY 1, 2006 IF YOU MAKE A PURCHASE WITH A CHECK, your student id number will be written on your check. if you do not wish to have your student id number appear on your check, you must use an alternate form of payment!

CREDIT CARD ACCEPTANCE POLICY

LACC Bookstore accepts VISA, MasterCard, American Express and Discover credit cards when presented with the student's current registration or Associated Students Organization identification card. A valid California Drivers License or I.D. card is required for identification and signature verification purposes only. The person the card is issued to must be present.

NO CASH REFUNDS will be issued on a credit card purchase. Merchandise must be returned by return deadline to qualify. A credit will be issued and forwarded to the credit agency and a copy given to the customer. **

Please note: refunds are sent to our bank each night...your bank may take up to 3 weeks to credit your account.

CASH PURCHASING POLICY

Merchandise must be returned by return deadline to qualify. Cash refunds will be issued at time of return if all other refund policy qualifications are met.

BOOK BUYBACK

No refunds on textbooks purchased during finals. Books may be sold back to the Bookstore at the end of each semester (during finals). The Bookstore will make an effort to Buy Back as many texts as possible from LACC students. It is not an obligation on the part of the Bookstore, but a special service we perform to help keep the cost of books down. How books qualify for buyback- for a book to be bought back by the LACC Bookstore, all of the following conditions must be met. The book will then be purchased at 50% of the purchase price.

Check posted signs for dates and times the bookstore will often offer buyback at the beginning of each major term.

1. A signed adoption by the department.
2. Needed for the LACC Bookstore inventory for the next semester.
3. The book is in the correct edition, volume, etc. and in good condition (limited writing and underlining are permissible in most texts). No water damaged books will be accepted.

- The LACC Bookstore will not buy back workbooks, study guides, syllabi or supplementary related materials.
- Final determination of the condition and resale value of a textbook shall be made by Bookstore Management

- Textbooks not bought back by the Bookstore may be purchased by the company conducting the buyback, at a lesser price, subject to that company's buying policy. The Bookstore regrets it cannot buy back all books.

BUSINESS OFFICE

Cesar Chavez Administration Building 111
(323) 953-4000 ext. 2172

The College Business Office handles all college fund collections, club accounts, and Associated Student Organization funds in accordance with LACCD Board rules and is subject to audit.

CAHSEE BRIDGE TO COLLEGE

CCW 3020 Wilshire Blvd. , rm. 216- (323) 953-4000 x 2467

The CAHSEE Program (California High School Exit Exam) is designed to assist students who have not completed high school graduation requirements or need to strengthen English and/or math foundations. The Program provides basic skills English and math courses designed to help students prepare for the CAHSEE, GED, and basic skills assessments. In addition to providing courses, a wide variety of support services are available to students who qualify. Some of the services include free class materials, bus tokens, snacks, Success Workshops, one-on-one and group tutoring, in-class tutors, four-year college tours, and job placement assistance.

CAL WORKS

Learning Resource Center, lower level • (323) 953-4000 ext. 2597

Cub Center 209A (next to Bookstore) • (323) 953-4000 ext. 2586

<http://www.lacitycollege.edu/services/calworks/>

Our office provides CalWORKs students with comprehensive support to enables them to be successful in their Welfare to Work (WTW) activity and take positive strides towards self-sufficiency.

The California Work Opportunity and Responsibility to Kids (CalWORKs) Program is part of the Office of Economic & Workforce Development in Academic Affairs. CalWORKs is a comprehensive effort by the State of California and the County of Los Angeles Department of Public Social Services (DSPS) to provide education, skills assessment, short/long term training, counseling, job development, child care, resource and referral, and other supportive services to eligible welfare recipients. CalWORKs students are referred to LACC by their county offices to participate in program including: English as a Second Language (ESL); Adult Basic Education (ABE) or Remedial Education (REM); General Education Diploma (GED); Self Initiated Participant (SIP); Vocational Training (VOC); Job Services Training (JST); and/or Work Experience (WEX). Our office also provides students with: important information about the changes in Welfare to Work (WTW) policies; verifications; progress reports; and assistance with other county paperwork or issues regarding GAIN participation.

CAMPUS CHILD DEVELOPMENT CENTER

(323) 953-4000 ext. 2220

The Campus Child Development Center offers a preschool program for children 3 to 5 years of age and an evening program for school age children. The Center provides a developmentally appropriate curriculum that responds to the individual needs of the children, incorporating the learning domains of social, physical, cultural, cognitive and emotional growth. Enrollment is available for the children of LACC student/parents to assist them in completing their educational goals. Priority is given to low-income families. Applications for enrollment are available at the Campus Child Development Center. Applicants are encouraged to apply early because enrollment is limited. A fee may be charged, based upon the family size and income. Many families qualify for the grant program and receive subsidized child care.

CAREER & JOB DEVELOPMENT CENTER

Administration Building 109 • (323) 953-4000 ext. 2210

<http://www.lacitycollege.edu/services/career/index.html>

The Career and Job Development Center provides students with career assessment (testing), career counseling, and information on career choices. The Center offers vocational testing to identify interests, abilities, personality

type, and work values related to career options. In addition, there is a career resource library and internet accessible computers with software programs (i.e. EUREKA) to assist in the career exploration process. The Career Center offers workshops, resume assistance and has information on internships. Services are provided by appointment and on a walk-in basis when available.

COMPLIANCE OFFICER

Cesar Chavez Administration Building 208C • (323) 953-4000 ext. 2249

<http://www.lacitycollege.edu/resource/complianceoffice/index.htm>

Los Angeles City College prohibits discrimination based on sex (including sexual harassment, sexual orientation), race, color, pregnancy, ancestry, national origin, religion, creed, marital status, disability, medical condition (cancer related), age (40 & above) and/or veteran status. This is in accordance with applicable federal and State law and District College policy. The policy applies to admission, access and treatment in College programs and activities for all full-time and part-time students.

Sexual harassment is one form of discrimination. It is generally defined as unwelcome sexual advances and/or requests for sexual favors by a male or female. Sexual harassment is physical, verbal, or visual behavior that is sexual in nature, repeated, and interferes with your ability to study or work. It is conduct that has created a hostile or intimidating environment.

The role of the Compliance Officer is to implement policies and procedures that follow Federal and State laws on discrimination and sexual harassment, oversee compliance, investigate and recommend resolutions to discrimination and/or sexual harassment complaints, serve as a resource on relevant issues and promote diversity. Students who feel that they have been discriminated against or sexually harassed or who wish to discuss incidents of discrimination or sexual harassment may contact and/or file a complaint with the Compliance Office.

Copies of the Discrimination and Sexual Harassment Policy and relevant compliant forms may be obtained upon request from the Compliance Office or online.

CONTRACT EDUCATION

Cesar Chavez Administration Building 208 • (323) 953-4000 ext. 2062

(Academic Affairs) ext. 2595 (Workforce Education)

Contract Education is designed to enhance the economic development of the State of California. All courses and programs are taught by qualified faculty and meet the same standards of academic rigor as does the traditional, campus-based program. For additional information, contact the Office of Economic & Workforce Development in Academic Affairs.

Through its Contract Education program, LACC provides credit courses and complete lower division transfer programs as well as not-for-credit workshops and customized seminars, for business, industry, and government agencies. The course offerings may be provided on company or agency premises or on campus. Contract Education course work is paid for by the contracting company or agency.

COMMUNITY SERVICES

Administration Building 112 • (323) 953-4000 ext. 2650

www.lacitycollege.edu/comsvcs/

The Los Angeles City College Community Services Program provides a full range of not-for-credit classes and programs designed to meet the educational, social, recreational, cultural, and civic needs of residents in the

college community. Fee and grant funds are received for programs to make them self-supporting.

Educational programs offer the community an opportunity to explore a variety of personal interest areas of learning and to update individual knowledge and skills. Moreover, recreational, cultural, and social programs offer opportunities for community residents to participate in such activities as not- for-credit, short-term programs in dance, martial arts, physical fitness, gymnastics, and sports as well as a variety of self- directed activities.

COUNSELING DEPARTMENT

Cesar Chavez Administration Building 108
(323) 953-4000 ext. 2250

www.lacitycollege.edu/services/counsel/index.html

Academic counseling services are available for all students in the Counseling Department. Students are encouraged to make an appointment to consult with a college counselor. If students need to review their records, appointments should be made in person several days in advance.

No appointments are available the first week of the semester. Walk-in counselors are available to answer quick questions or to provide emergency help for students.

The services available include counseling and guidance on educational, career, and personal goals as well as problems that may interfere with a successful adjustment to college life. The experienced and professionally trained counseling faculty works with students concerning transfer, educational goals, career planning, choice of college or universities, and other decisions involving a direction in life. Counselors also help students select and plan their academic majors, explore future college or other educational choices, and develop specific plans to meet their transfer and graduation goals. Students should consult with a college counselor as soon as possible to make these plans.

Counselors will work with students who feel the need for greater self-understanding, who need to know more clearly what their abilities and interests are, and where these abilities and interests may lead.

Personal Development courses offered through the department have been structured to prepare and help students complete their college education in a timely manner. The courses are highly recommended for new and returning students.

ENGLISH LITERACY & CIVICS

CCW - City College at Wilshire - 3020 Wilshire Blvd. • (323) 953-4000 ext. 2230 www.lacitycollege.edu/services/citizenship/index.html
also see the “Programs & Courses: Citizenship” section

The LACC English Literacy Program and Citizenship Center are part of the Office of Economic & Workforce Development in Academic Affairs. The English Literacy Program provides eligible students with instruction in non-credit English as a Second Language (ESL), Vocational ESL, Basic Skills, and Tutoring Services, while the Citizenship Center is focused on providing students with all services necessary for completing the citizenship process. These services are available to any permanent resident who has lived in the United States for five years. The Center assists with the N400 form, provides information, takes photographs, sponsors test preparation workshops, and administers the CASAS approved Citizenship Examination.

EXTENDED OPPORTUNITY PROGRAMS & SERVICES (EOP&S) COOPERATIVE AGENCIES RESOURCES FOR EDUCATION (CARE)

Clausen Hall 111B • (323) 953-4000 ext. 2300 & 2301

<http://eops.lacitycollege.edu/>

EOP&S is a state-funded program for nontraditional students who are affected by educational and economic barriers. The program motivates students in reaching their career and educational goals by providing support services and encouragement. EOP&S provides the following services: intensive academic, career and personal counseling, individualized tutoring, priority registration, transfer assistance, educational workshops, and book vouchers.

CARE- The CARE Program is a supplement program withis EOP&S that provides additional support services for single parents receiving TANF/ CalWORKs subsidies. CARE students are eligible for all EOP&S services plus childcare referrals, meal tickets, parking permits, auto gas card (if funding permits), parenting and job preparation seminars. CARE offers personal and professional support while assisting participants to meet their educational goals.

Bring your registration receipt showing 12 or more active units to Clausen Hall 111B to find out if you qualify. OSS students must be enrolled in 6 or more active units to apply.

EXTRA- & CO-CURRICULAR ACTIVITIES

In addition to the regular academic offerings of the College, various departments make noteworthy contributions to the cultural life of LACC students and its community. Listed below are College-authorized “extra-curricular” (outside or supplemental to course work) activities available to LACC students.

The Art Department presents exhibitions of interest to the diverse community served by the College. The gallery in DaVinci Hall features drawing, painting, graphics, photography, sculpture, and ceramics by artists of local and international reputation, as well as offering a first-time gallery exhibition experience to students.

Forums, guest speakers, and art demonstrations are presented throughout the year and are open to the general student body. Student work is prominently displayed in the first and second floor cases in DaVinci Hall.

The Annual Art Competition and subsequent scholarships reward outstanding department students with cash awards based on submitted portfolios.

The *Citadel* is the creative arts and literary journal of Los Angeles City College, presented through the English department. The *Citadel* publishes works of art, photography, fiction, novels-in-progress, essays, manifestos, and poetry by LACC students. The *Citadel* publishes work that reflects the socio-cultural changes taking place on campus, in the city, as well as in the world.

The *Citadel* addresses issues that reflect changes due to America's growing diversity; reviews and illuminates LACC's understanding, respect, and eager embrace of the many cultural aspects of its students from around the world.

The Music Department presents noontime concerts twice weekly during the academic year. The concerts feature outstanding student soloists, ensembles, and guest artists. The department also presents several evening concerts, given by the musical organizations of the department. The

concert experiences are designed to keep students informed about current developments in various phases of the music profession.

The Theatre Arts department and the Theatre Arts Academy present several plays each semester utilizing up to three theatres located on campus: the Camino, the Caminito, and the Cameo. In existence since 1929, the department has built a reputation for excellence that is nationally recognized. Scores of its graduates have been invited to Washington, D.C. as part of the Kennedy Center/American College Theatre Festival.

In 1965 the department was designated by the Community College Board of Trustees as the professional theatre training school for the Los Angeles Community College District. It is the largest, most comprehensive professional theatre training institution in the West.

As with extra-curricular activities, various departments make noteworthy contributions to Los Angeles City College students and its community through their "co-curricular" (related to course work) activities. Listed below are College-authorized co-curricular activities available to LACC students.

The "Collegian" is the official student newspaper for Los Angeles City College. It is published twice a month during the academic year. Its purposes are to disseminate information of interest to the college students, faculty, staff and administrators and to offer a means for practical application of the journalistic principles and techniques taught through the Media Arts department.

The "Collegian" is published as a learning experience, offered under the College's journalism instructional program of the Media Arts department. The editorial and advertising materials published, including any opinions expressed, are the responsibility of the student newspaper staff, free from prior restraint under the First Amendment to the United States Constitution. Accordingly, material published, including any opinions expressed, should not be interpreted as the position of the Los Angeles Community College District, Los Angeles City College, or any LACCD or LACC officer or employee.

The Department of Speech Communication provides opportunities for students to compete in intercollegiate debate tournaments as well as individual Forensics events. Having existed at LACC since the 1930's, the Forensics squad participates in local state, and national competitions throughout the academic year. Established on a strong winning foundation, the current student competitors continue the tradition in speaking events ranging from debate to oral interpretation of literature.

FINANCIAL AID

Clausen Hall 111A • (323) 953-4000 ext. 2025

<http://www.lacitycollege.edu/stusvcs/finaid/>

For more information, see the section on Financial Aid at the beginning of the catalog.

FIRST YEAR EXPERIENCE

The First Year Experience Learning Community is a program that allows freshmen students an alternate approach to learning that encourages relationships with peers and their instructors. Participants will enroll in selected classes as a group. Peer mentors will be assigned to assist in the classroom. Academic counseling will be provided for all participants, helping

to ensure the students' academic needs are met. Such reinforcement helps student retention, encourages student partnerships, and creates an encouraging learning environment. Interested students should apply as soon as possible because space is limited.

THE FOUNDATION

LOS ANGELES CITY COLLEGE FOUNDATION

Bungalow B • (323) 953-4000 ext. 2490

www.laccfoundation.org The Foundation provides deserving students with the opportunity to achieve their academic goals by providing a full range of scholarships and awards. All awards and scholarships are given on an annual basis normally during the Spring semester. For application, criteria and requirements visit the foundation website: www.laccfoundation.org. The specific and primary purposes for which the Foundation is formed are: (1) To promote, foster, encourage and provide scientific, literary, educational and recreational facilities at LACC; (2) To provide for scholarships, fellowships, grants in aid, loans and other financial assistance to worthy students and members of the faculty; (3) To further research and provide for associated facilities; (4) To receive gifts, bequests or devises either outright or as a trustee or beneficiary of a trust, to hold, transfer, buy, sell, invest, or reinvest real property, cash, stocks and bonds, and all other evidences of value; (5) To expend moneys for the general welfare of the students and faculty of LACC; and (6) To otherwise provide aids to education supplementary to state and local tax means for the support and benefit of LACC.

The Foundation is a non-profit, tax-exempt corporation, designed to receive gifts for the college from individuals, corporations, and foundations. Our tax payer ID# is 95-6207819.

FOSTER & KINSHIP ARE EDUCATION AND THE INDEPENDENT LIVING PROGRAMS

(323) 953-4000 ext. 2335

Los Angeles City College offers various educational programs, ranging from basic to advanced levels, to help Foster Care providers meet the complex and unique needs of the children placed in their homes. The Foster Care Education program trains Foster Parents and Foster Care providers to improve the lives of families in crisis by promoting teamwork and sensitivity. All classes are open to various types of Foster Care providers although some classes do have enrollment limits to Foster Family Agencies, Social Workers, and Group Home Staff, among others.

Available workshops include: Foster & Kinship Care Education (FKCE); Independent Living A or B (Adults or Teens); Medical or Specialized FKCE Pre-Service (F- Rate or D- Rate); State Mandate Training (B – Rate); Model Approach to Partnerships in Parenting (MAPP); Kinship Education Preparation Support (KEPS); Enhanced KEPS Orientations; Kin-Gap Orientations. Certificate provided upon completion of the requirements.

LOS ANGELES CITY COLLEGE GUARDIAN SCHOLARS

EOPS/CARE - Clausen Hall 111 (323) 953-4000 ext. 2300

The LACC Guardian Scholars (GS) Program is a comprehensive program that supports current and former foster youth from 16-24 years of age as they pursue their educational/vocational goals. GS provides a seamless integration of student support services including admissions, financial aid, counseling, OSS and EOPS/CARE. The program is conducted under the auspices of the EOPS/CARE program which has the primary function of

supporting and assuring that each Foster Youth student is adequately guided and mentored throughout the entire educational process.

HEALTH & WELLNESS CENTER

Holmes Hall 1 and 2 • (323) 953-4000 ext. 2485

The Health Center services all currently enrolled students. It offers basic primary and non-emergency care, health care counseling, emotional and behavioral counseling, family planning, referrals, TB skin test, and other laboratory tests and immunizations (TD, Hep B, MMR), some which carry additional fees. Appointments can be made to see a medical provider or mental health professional.

A mandatory Student Health Fee of \$11.00 per semester is payable at the time of registration. (For information on Health Fee Waivers, see “Policies: General.”)

HEALTHY ADVOCACY RESPONSE TEAM (HART)

(323) 953-4000 ext. 2450

The College has trained staff to assist students who may be victims of rape, sexual assault and/or stalking. Students who have been assaulted should immediately go to the College Sheriff Office to report the incident -

(323) 662-5276. Or, from any campus pay phone, dial #3.

Inquiries about this team should be directed to the Chair of HART at (323) 953-4000 ext. 2450 or 2280.

HONORS PROGRAM

(323) 953-4000 ext. 2058

http://www.lacitycollege.edu/services/honorsprogram/Page_1x.html

The Honors Program is designed to prepare the highly motivated student for transfer. Honors students who complete 18 units of Honors credit will receive certification in the Transfer Alliance Program (TAP). This guarantees priority consideration for admission to non-impacted majors in UCLA's College of Letters and Sciences, and increases the students' chances of being admitted. Other partners include UC Irvine, UC Riverside, UC Santa Cruz, Occidental College, Chapman University, and La Sierra University.

For more information see the “Transfer Information” section.

INTERCOLLEGIATE ATHLETICS **Currently not offer**

Stadium Office • (323) 953-4000 ext. 2850

<http://athletics.lacitycollege.edu/>

Los Angeles City College offers a variety of sports for men and women student athletes. The college belongs to and competes in the South Coast Conference and is a member of the California Commission on Athletics (COA.)

NOTE: Offerings are subject to change.

Women's Cross Country
Men's Basketball
Women's Basketball
Women's Track & Field
Baseball
Women's Badminton
Women's Volleyball

1. A student may submit a request to both the Vice President of Academic Affairs and the Athletics Director simultaneously.

2. Both the Athletic Director and the Vice President will review the

request and confer with the college researcher to determine, based on the most recent study survey, if this sport is on the top of the priority list and meets with Title IX, Gender Equity in Sports.

3. If the requested sport ranks high on the survey list and is in compliance and conforms with Title IX requirements, the Athletic Director will then make a recommendation to the Shared Governance Council, which will discuss the request and make a recommendation to the College President.

4. Upon receiving the recommendation from the Shared Governance Council, the President will decide if the sport is viable with respect to the budget and will recommend the appropriate semester to implement the new sport in accordance with the sport season dates as established by the Commission on Athletics.

INSTRUCTIONAL TELEVISION (ITV)

www.lacitycollege.edu/ITV • (818) 833-3594 (Mission College Office)

<http://www.lamission.edu/itv/>

ITV allows the students to take general education classes which meet transfer and graduation requirements at their own pace through videos and the internet. The award winning videos provide course content, the internet provides an online community for class discussions, virtual tours and online quizzes. Exams are taken on campus, there are on campus seminars on the weekends (approximately once a month). Students may attend seminars and take exams on campus. All classes are three units, except Math 125 which is five units. The tuition is the same as on-campus classes.

INTERNATIONAL STUDENT CENTER

Cub Center • (323) 953-4000 ext. 2470

<http://intl.lacitycollege.edu/>

The LACC International Student Center is a one-stop office that provides admissions, testing, academic counseling, registration, adding and dropping of classes, letters of certification, transcripts, intent to transfer letters and on-campus and off-campus work authorization. The Center also assists students with paperwork to apply to the Immigration and Naturalization Service for change of status, practical training, extension of stay, reinstatement to student status, and transfer to other institutions of learning. Los Angeles City College is authorized under Federal law to enroll nonimmigrant alien students.

International Students: Eligibility For Admission to LACC

To be eligible for admission to Los Angeles City College, the student must:

- Have a score of four-hundred-fifty (450-paper based/133-computer based/45-internet based/) or more on the TOEFL (Test of English as a Foreign Language).
- Show the ability to pay the nonresident tuition, currently \$169 per unit.
- Have earned a high school diploma from a high school in the United States or the equivalent education from a foreign country.

(Immigration requires students to be enrolled in 12 semester units to maintain visa status.) The student must also show the ability to pay living and personal expenses for twelve (12) months, which are estimated to be \$10,000. If you are currently living outside the United States, the deadlines are May 30 for the Fall semester and November 15 for the Spring semester. For

additional information, write to:

Director, International Student Program
Los Angeles City College
855 North Vermont Avenue
Los Angeles, CA 90029

- 130 Magazine and Newspaper Subscriptions plus historical issues
- Online Databases with Remote Access

JOB PLACEMENT SERVICES

Cesar Chavez Administration Building 109 • 953-4000

Current and graduated LACC students are entitled to use the job placement services of the College and those at all Los Angeles Community College District colleges. A job board listing current offerings in the LACC service area is located outside the Student Assistance Center.

LEARNING SKILLS CENTER

Learning Resource Center, lower level.

(323) 953-4000 ext. 2770 or 2772

The Learning Skills Center (LSC) provides the opportunity for students to improve their basic study skills in mathematics and language arts. Students may register for classes in the LSC up through the first fourteen weeks of the semester. One-unit classes are offered on an open entry/ open exit basis and can be taken as credit/non-credit. (Credit for individualized, self-paced, open entry/open exit courses may not be counted as part of a student minimum load in qualifying for benefits until the courses have been completed.)

Programs are individualized and developed on the basis of diagnostic tests administered to each student to determine his or her academic needs. A student's program is designed to include self-paced instruction, instructor-student conferences, and peer tutoring sessions. Emphasis is placed on the improvement of basic skills in reading, vocabulary, study skills, writing, grammar, basic mathematics, and algebra. Tutoring in most subjects is available. The LSC also offers small group classes in conversation, speech, resume writing, and math anxiety.

LIBRARY

Martin Luther King, Jr., Library • (323) 953-4000 ext. 2400

www.lacitycollege.edu/resource/library/

The library features:

- Reference Center with Faculty Librarians for Research Assistance
- Circulation/Periodicals Desk with Textbooks, Reserve Material, Magazines, and Newspapers
- 170 Computers for Students
2 ADA Stations
2 Tables with low/high adjustability
- Wireless Access
- Photocopy Center
- 2 Print Station Desks with B&W and Color Copying & Printing
- 17 Group Study Rooms
- 150,000 Books (11,000 eBooks)

A library brochure and instructor-requested orientations are available through the Reference Center. Two one-unit courses are offered: LS 101 Library Research Methods and LS 102 Internet Research Methods. Individual questions are welcomed at the Reference and Circulation/Periodicals Desks. Students must use their valid college identification card to qualify for library privileges. When the library is closed, materials may be returned through the outside chute located on the front of the building.

LOST AND FOUND

Cesar Chavez Administration Building 115 • (323) 662-5276

Inquiries about personal belongings lost on campus should be directed to the Campus Sheriff's office.

OFFICE OF SPECIAL SERVICES

Clausen Hall 109 • (323) 953-4000 ext. 2270 • TDD (323) 667-0812

www.lacitycollege.edu/services/DSPS/

The Office of Special Services (OSS) is one of the student services at Los Angeles City College designed to provide educational support and access to programs for currently enrolled students. A variety of programs and services are available to eligible students with disabilities, providing them the opportunity to fully participate in Los Angeles City College's programs and activities through appropriate and reasonable academic accommodations. Provision of these accommodations allow students with disabilities equal access to all aspects of their education, however students must master all competencies required by Title B of the California Educational Code and comply with the Student Code of Conduct adopted by Los Angeles City College.

The following OSS offices are located in Clausen Hall 109: Counseling, ACL, Tutoring, the High Technology Center, and Learning Disabilities Services. Additional counseling is available in the main Counseling Office. Services provided include but are not limited to: information and referral, advocacy and liaison, academic counseling, learning disability assessment, special education and learning skills classes, high technology center, sign language interpreter, readers, note takers, captioning and Braille transcription.

RELATED INFORMATION (NOT HANDLED BY OSS)

Disabled Parking

Disabled parking spaces are available in all college designated parking lots. Any vehicle parking in a college disabled parking space must display a State of California issued Disabled Parking Placard or they will be issued a citation.

Closed Captioning

Federal laws require that all instructional videos be closed captioned to ensure that all students have full access to instructional material. Academic Departments needing to close caption existing videos should contact OSS. Any new instructional videos purchased by the college must meet this requirement.

SATELLITE LOCATIONS

CITY COLLEGE AT WILSHIRE - 3020 Wilshire Blvd.

<http://www.lacitycollege.edu/offsite/ccw>

City College at Wilshire is located on the 2nd floor of 3020 Wilshire Boulevard, east of Vermont - (323) 953-4000 ext. 2230.

NORTHEAST CAMPUS

Fletcher & San Fernando Rd./Atwater Village

Contact the Los Angeles Community College District offices for detailed information - 213-891-2476

<http://www.laccd.edu>

We also offer distance learning (taking classes via computer and/or video) through Instructional Television and on-line courses.

STUDENT LIFE - ACTIVITIES

Learning Resource Center • (323) 953-4000 ext. 2450

The Student Activities Office coordinates many events, including Welcome Days, Graduation, the Dean's Honor Ceremony, and the Dean's and President's Honor Certificates. The Associate Dean of Student Life is the advisor for the Associated Student Organization (ASO), which represents the student body. The Associate Dean also serves as the College Ombudsperson and facilitates the student grievance process.

STUDENT ASSISTANCE CENTER

Cesar Chavez Administration Building 105

(323) 953-4000 ext. 2455

The Student Assistance Center is the first stop for students who want to register for classes. A multilingual staff assists students in completing applications for admission to LACC. The Center provides a wide range of support systems, including general campus information as well as a confidential evaluation and referral service. The Center offers community referrals for employment, child care, medical treatment, family planning, county public assistance, housing, legal aid, and psychological counseling.

TRIO/STUDENT SUPPORT SERVICES

Clausen Hall 116 • (323) 953-4000 ext. 2468/2466

www.lacitycollege.edu/services/trioss/

TRIO/Student Support Services is a federally funded program designed to serve 160 students who have identified transfer to a four-year university as their academic goal. To meet eligibility requirements, students should be low income, first generation college students and/or students with disabilities evidencing academic need. Eligibility requirements also include having a GPA in the “C” range and students who have not completed an Associate's degree. Participants must be U.S. Citizens or permanent residents. Services provided include academic, career and personal counseling, full financial aid package consideration, tutoring referrals, educational workshops, (eliminate priority registration), free cultural events & field trips, computer lab usage, and laptop/calculator loan program. Interested students should apply as soon as possible because space is limited.

UNIVERSITY TRANSFER CENTER

Cesar Chavez Administration Building 109 • (323) 953-4000 ext. 2215

<http://www.lacitycollege.edu/services/transfer/>

At LACC, you can complete the first two years of a Bachelor's degree then transfer to a 4-year university as a Junior. Representatives from the University of California and California State University campuses, as well as private universities, visit the Center on a regular basis to provide up-to-date transfer information to students. Questions on the transfer process, admission requirements and procedures, financial aid, majors and student services are answered. UC, CSU and USC applications are available, and workshops on various aspects of transferring are scheduled throughout the year. Also, catalogs from every accredited college and university in the United States are available in the Center and on websites and CD Rom.

For more information see the “Transfer Information” section.

UPWARD BOUND

Administration Building 100J • (323) 953-4000 ext. 2315

<http://www.lacitycollege.edu/services/upwardbound/ubprogram1.htm>

The Upward Bound Program is a federally-funded program designed to prepare high school students for success in college and professional careers. It is one of 500 such programs funded nationwide, all of which are working to increase representation of low-income students in higher education. The program serves students from Belmont, Fairfax, Hollywood, and Manual Arts High Schools, and provides academic support and career guidance services to students from their tenth grade until they graduate from high school, and enter a post-secondary education program. Students qualify for the program by being from low-income families where the parents have not earned a B.A./B.S. degree.

During the academic year, the Upward Bound Program provides participants with tutoring and advising services at their high schools and conducts Saturday Academy sessions on the LACC campus. Every summer, participants attend an intensive 6-week Summer Academic Program at LACC, where they enroll in courses and earn credits towards high school graduation. Instruction includes courses in Math, English Composition, Laboratory Sciences, Computers, Languages, Social Studies, and various Visual and Performing Arts. Throughout the year, the program provides tutoring services, instruction in college-level study skills, exposure to professional careers, and guidance through the college application and financial aid processes. The program also conducts trips to four-year colleges and universities, theatre performances, leadership conferences, and other enriching experiences.

VEHICLES ON CAMPUS

See The Current Schedule of Classes For Additional And Current Parking Information

Board Rule 7400. Parking And Movement Of Vehicles

Parking and movement of vehicles on District-owned property shall be controlled by the College President, who shall prepare, post, and make available any special regulations. The LACCD Chancellor shall make these regulations available at the District office. Vehicle Code 21113.

Board Rule 7401: Damage Or Loss Of Property

Neither the Board of Trustees nor the Los Angeles Community College District shall be responsible for damage to or loss of vehicles or loss of contents thereof from any cause whatever except in those instances in which the District would be liable under Government Code including, but not limited to, Government Code 810 to 996.6, inclusive.

Board Rule 7402: Injury

Neither the Board of Trustees nor the District shall be responsible for any injury to persons arising out of or in connection with the presence of or operations of vehicles on District property except in those instances in which the District would be liable under the Government Code including, but not limited to, Government Code 810 to 996.6, inclusive.

VETERANS' AFFAIRS OFFICE

Clausen Hall 109 • (323) 953-4000 ext. 2024

Veterans, service members, and their survivors and dependents may apply for their VA Educational Benefit Programs through the Veterans' Affairs Office. To initiate the VA Certification Process, Veteran students must complete a VA

LACC
LOS ANGELES CITY COLLEGE
Build Your Future!

- *Theater*
- *Paralegal*
- *X-Ray Tech*
- *Dental Tech*
- *Information Tech*
- *Law Enforcement*
- *Cinema/Television*
- *Registered Nursing*

Vermont/Santa Monica Redline Stop

ENROLL TODAY

LOS ANGELES CITY COLLEGE
855 NORTH VERMONT AVENUE • LOS ANGELES, CA. 90029
www.lacitycollege.edu
888.953.LACC

Application form and submit it with their DD-214, Verification of Enrollment, and Veteran Educational Plan to the Veterans' Affairs Office. An advance payment of the benefits may be obtained, if eligible, by submitting a request at least 30 days prior to the start of the enrollment period to be certified.

Veteran students who had previously attended another post-secondary institution must submit a transcript from the institution (civilian and military) for evaluation by an academic counselor prior to certifying for a second enrollment period. Los Angeles City College, as required by the Department of Veterans Affairs (DVA) policy, conducts an evaluation of all prior postsecondary education, experience and training (civilian and military) before certifying for a second enrollment period. As required, Los Angeles City College grants the appropriate credit, shortening the training period proportionately, and notifies both the DVA and the student of the amount of credit allowed towards their declared program.

Unless otherwise notified, all programs (majors) in this catalog are approved for VA benefits payment. Transfer programs are approved contingent upon Los Angeles City College having current articulation agreements with the universities offering the transfer programs. Contact the Transfer Center for more information about approved transfer programs. To maintain eligibility, Veteran students must maintain standards of academic progress as indicated in the College Catalog.



Computer Applications - Office Technology (CAOT)Dr.	Thelma Day	Cesar Chavez Admin. Bldg. 304 / ext. 2549
Computer Science - Information Technology/Computer Technology	Roger Wolf	Franklin Hall 103 / ext. 2810
Counseling (Personal Development)	Reri Pumphrey	Cesar Chavez Admin. Bldg. 108 / ext. 2250
Dental Technology	Dana Cohen	SCI 324A/ ext. 2502
Electronics	Roger Wolf	Franklin Hall 103 / ext. 2810
Engineering	Dr. Jayesh Bhakta	SCI 222D/ ext. 2923
English/ESL	Dr. Tammy Robinson	SCI 222E/ ext. 2700
Foreign Language & Humanities	Eiko Chatel	Da Vinci Hall 312B / ext. 2737
Earth Sciences & Chemistry	Dr. John Freitas	SCI 324B / ext. 2600
Humanities	Eiko Chatel	Da Vinci Hall 312B / ext. 2737
Journalism (Media Arts)	Daniel Marlos	Bung. 2A/ ext. 2835
Law/Administration of Justice	Wilhelm Vargas	Holmes Hall 200F / ext. 2754
Learning Skills	Maryanne Des Vignes	Learning Resource Center 103 / ext. 2770
Library Science	Barbara Vasquez	Library 216 / ext. 2407
Life Science (Biology/Anatomy)	Greg Gonsalves	SCI 222E / ext. 2796
Math	Roger Wolf	Franklin Hall 103 / ext. 2810
Music	Dr. Dan Wanner	Clausen Hall 243 / ext. 2880
Nursing	Betsy Manchester	SCI 213 / ext. 2065
Philosophy	Julio Torres	Holmes Hall 200 / ext. 2763
Photography (Media Arts)	Daniel Marlos	Chemistry Basement / ext. 2835
Physical Education - Health and Dance	John Erdhaus	Men's Gym 104 / ext. 2860
Psychology	Dr. Rochelle Sechooler	Holmes Hall 100 / ext. 2930
Physics/Astronomy/Engineering	Dr. Jayesh Bhakta	SCI 222D / ext. 2923
Radiologic Technology (X-Ray)	John Radtke	Radiologic Technology Bldg. / ext. 2942
Social Science	Dr. Wendel Eckford	Franklin Hall 219E / ext. 2561
Speech	Jeanne Dunphy	Communications Bldg. 190 / ext. 2967
Theater	Kevin Morrissey	Theatre Arts Bldg. 117 / ext. 2992

- Aaron, Melvin C. (2001)
Associate Professor of History
B.A., University of California, Santa Barbara
M.A., University of Washington
Ph.D. Candidate, Howard University
- Adeniyi, Adeleye (1993)
Associate Professor of Mathematics
B.S., M.S., Indiana State University
- Aguilar, Hector R. (1988)
Associate Professor of Counseling
B.A., University of California, Los Angeles
M.Ed., California State University, Dominguez Hills
- Allen, Joyce Faye (1989)
Professor of Learning Skills
B.A., Pitzer College
M.A., California State University, Dominguez Hills
- Alvarez, Henry V. (1978)
Professor of Counseling
A.A., Los Angeles City College
B.A., M.A., San Jose State University
- Anderson, Robert (2005) Assistant
Professor of Real Estate
B.A., St. Lawrence University, Canton
M.B.A. Wayne State University
California Real Estate Broker
- Armstrong-Turner, Cheryl (1993)
Professor of Counseling
B.A., Fisk University
M.S.W., University of California, Los Angeles
M.A., University of California, Irvine
- Arvidson, Dean (1995)
Associate Professor of Physics/Astronomy
B.A., University of California, San Diego
M.S., California State University, Los Angeles
- Auza, Enrique A. (1977)
Professor of Economics
B.A., University of the Pacific
M.A., Sacramento State University
- Ayuyao, Elenita (1984)
Professor of Business Administration
B.S.C., University of Santo Tomas
Certified Public Accountant, State of California
- Badalian, Raymond (1995)
Associate Professor of Mathematics
B.S., M.S., Claremont
- Bae, Youngmin (2001)
Associate Professor of
Foreign Language and Humanities
B.A., University of California, Los Angeles
M.A., University of California, Davis
- Baprawski, Carmen Fabrega (1988)
Professor of Counseling
A.A. Los Angeles City College
B.A., M.A., California State University Los Angeles
M.S., Pepperdine University
- Beaufait, Kathleen (1989)
Associate Professor of Speech
B.A., M.Ed., Marygrove College
- Bell, Brenda
Associate Professor of CAOT
B.A., Albany State University
M.A., Claremont Graduate University
- Belviz, Mely M. (1988)
Associate Professor of Counseling
B.S.E., University of the East
M.A., University of St. Thomas; University of
California, Los Angeles
- Bernard, Guy R. M. (1989) Associate
Professor of English/ESL
B.A., M.A., University of California, Los Angeles
TESL
Certificate, University of California, Los Angeles
- Bhakta, Jayesh (2005)
Assistant Professor of Physics/Engineering
B.S., Ph.D., University of Birmingham U.K.
- Bimber, Kathleen (1996)
Professor of Child Development
B.A., California State University, Northridge
M.A., Pepperdine University
- Blake, C. Marc (1979) Professor of Music
B.A., B.M., University of Redlands
M.M., Ph.D., University of California, Los Angeles
- Bledsoe, John (1993) Associate Professor of
Theater B.S., Woodbury University
B.A., University of California, Los Angeles
M.F.A., University of Southern California
- Blomquist, Jane (1979) Professor of Music
B.S., Concordia College
M.M., University of Southern California
- Blum, Jeffrey S. (1996)
Associate Professor of Psychology
B.A., M.A., Ph.D., University of California,
Los Angeles
- Boan, Terry A. (2001)
Associate Professor of Chemistry
B.S., M.S., University of California,
Santa Barbara
- Brady, Reginald (1989)
Assistant Professor of Counseling
B.A., M.A., California State University, Dominguez
Hills
Ph.D., California School of Professional
Psychology
- Brooks, Kerry S. (1979) Professor of Counseling
A.S., Compton College
B.A., M.S., California State University,
Los Angeles
- Bunn, Helen
Assistant Professor of Speech
- Caballero, Jesse (2000)
Associate Professor of Administration of
Justice B.S., California State University, Los
Angeles M.P.A., Pepperdine University
C.P.P., American Society of Industrial Security
- Canales, Carrie J. (2002)
Assistant Professor of Psychology B.A., Southern
Methodist University M.A., Pepperdine University
M.A., Ph. D., University of Southern California
- Cano, Thomas (1996)
Professor of Physical Education/Health
B.A., California State University, Los Angeles
M.A., Azusa Pacific University
- Carter, Elaine (1991)
Professor of Chemistry
B.S., Tufts University M.S.,
Boston University
- Caufled, Patricia (2001)
Associate Professor of Art
B.A., Cal State Dominguez Hills
M.F.A., Cal State Long Beach
- Genquizza, Lee
Assistant Professor of Life Science
- Chatel, Eiko Kitajima (1990)
Associate Professor of Foreign Languages
B.A. Kumamoto Women's University
M.A., California State University, Long Beach
- Chiu, Wayne (2004)
Assistant Professor of Architecture
B.A., University of Southern California
- Clark, Anthony (2005)
Assistant Professor of Sociology
A.A., Los Angeles Valley College
B.A., M.A., California State University, Northridge
- Cohen, Arax (1997)
Associate Professor of Dental Technology
C.D.T., National Board of Certification of Dental
Technology
B.S.B.M., University of Phoenix
- Cohen, Dana (1978)
Associate Professor of Dental Technology
C.D.T., National Board of Certification of Dental
Technology
B.S.B.M., University of Phoenix
- Colombo, Gary (1989)
Associate Professor of English
B.A., M.A., C. Phil., Brown University
- Conta, Mark
A.A., Grossmont College, San Diego
Los Angeles Police Officer, 32 Years
(323) 953-4000 ext. 2755
Email contamj@lacitycollege.edu
- Cowgill, Daniel P (1989)
Associate Professor of Health/Physical Education
B.A., Kinesiology, Pepperdine University
M.A.T., Sport Medicine, Pepperdine University
- Critelli, Michael J. (1971)
Associate Professor of Philosophy
B.A., University of California, Santa Barbara
M.A., Ph.D., University of Southern California
- Dakduk, Shawki (1999)
Associate Professor of Computer Science
B.S., Texas A&M University
M.S., California State University, Northridge
- Daniel, Blythe (1991)
Associate Professor of Psychology
- Dauzat, Brian P. (1996)
Associate Professor of Computer Science
B.A., University of California, Los Angeles
- Day, Thelma (1989)
Professor of CAOT
B.S., M.S., Jackson State University
Ed.D., Pepperdine University
- DesVignes, Maryanne D. (1988)
Associate Professor of Learning
Skills B.A., Howard University
M.A., California State University, Los Angeles
- Duffy, Thomas E., Jr. (1989)
Professor of Business Administration and Law
B.S., Miami University, Oxford, Ohio
J.D., Ohio State University
- Dunphy, Jeanne (1987)
Associate Professor of Speech
B.A., M.A., Arizona State University
- Eckford, Wendel (2005)
Assistant Professor of African American & U.S.
History
B.Arch, Prairie View A&M University of Texas
M.A., California State University, Dominguez Hills
M.A., Ph.D., Claremont Graduate University

- Egregor, Austin
Assistant Professor
- Eisenstein, Samuel A. (1961)
Professor of English
A.B., M.A., Ph.D., University of California, Los Angeles
M.A., Goddard College
Marriage, Family, Child Counselor,
State of California
- Erdhaus, John M. (1987)
Associate Professor of Physical Education
B.S., California State University, Los Angeles
M.S., California State University, Los Angeles
- Fate, Robert Fredrick (1978)
Professor of Theatre Arts
B.S., California Polytechnical University Pomona
M.S., University of Oregon
M.F.A., University of California, Los Angeles
- Ferreira, Leslie (1997)
Professor of Theatre Arts
B.A., University of California, Berkeley
M.F.A., Carnegie-Mellon University
- Fiazi, Kiomas (1972)
Associate Professor of Psychology
B.A., University of California, Los Angeles
M.S., University of Southern California
- Finney, Jackquelynn F. (1999)
Associate Professor of Radiologic Technology
A.A., Los Angeles City College
B.A., California State University, Northridge
C.R.T., Certified Radiologic Technologist
A.R.R.T., American Registry of Radiologic Technology
Registered in Radiology (R) and Mammography (M)
- Flores, Luis (1985)
Associate Professor of Computer Science
B.A., University of Southern California
M.S., University of California, Los Angeles
- Fonseca, Horacio (1975)
Professor of History, Ethnic Studies (PT. Ltd in PE)
B.A., California State University Hayward
M.A., University of California, Los Angeles
D.H.C., Universidad Nacional Autonoma De Mexico
- Freitas, John III (1996)
Professor of Chemistry
B.S., California State University, Sacramento
C.Phil, Ph.D., University of California, Los Angeles
- Friedlander, Carl A. (1980)
Associate Professor of English
B.S., California Institute of Technology
M.A., Stanford University
M.A., California State University, Northridge
- Fuhrmann, Dorothy (1985)
Associate Professor of Library Science
B.S., Northern Montana College
M.L.I.S., University of Southern California
- Gabrie, Constantino (1995)
Associate Professor of Dental Technology
A.A., Los Angeles Community College
A.A., Ventura Community College
B.S.B.M. University of Phoenix
C.D.T., National Board of Certification of Dental Technology
- Garcia, Martin
Associate Professor of Life Science
- Garcia-Salas, Emma (2005)
Assistant Professor of Counseling
A.A., West Los Angeles Community College
B.A., M.A., Loyola Marymount University
Ed.D., Pepperdine University
- Gengaro, Christine (2006)
Assistant Professor of Music
B.A., M.A., Hunter College,
City University of New York
Ph.D., University of Southern California
- Geuens, Jean-Pierre (1972)
Professor of Cinema
B.A., M.A., University of California, Los Angeles
Ph.D., University of Southern California
- Glickman, Daniez C. (1996)
Associate Professor of Physical Education
B.A., San Francisco State University
M.A., San Francisco State University
- Goddard, Rosalind K. (1998)
Associate Professor of Library Science
B.A., San Francisco State College
M.L.S., University of California, Los Angeles
- Gonsalves, Gregory (2001) Associate
Professor of Life Science
B.S., M.S., University of California, Riverside
- Gordon, Elizabeth (2001)
Associate Professor
of English/ESL B.A.,
University of South Florida
M.A., University of California, Los Angeles
- Guerrero, Carlos (2002)
Associate Professor of Chicano Studies
B.A., M.A., California State University, Northridge
Ph.D., Claremont Graduate University
- Guess, Rhonda D.
Assistant Professor
Certificat D'Etudes Francaises, Institut de la
Touraine—L'Universite de Poitiers
B.A., San Francisco State University
M.A., California State University, Northridge
Certificate, Professional Designation in Journalism,
UCLA Extension
- Guirguis, Menes (1989)
Associate Professor of Foreign Languages
B.A., M.S., M.A. Cairo University
M.A., University of California, Los Angeles
- Harris, Freddie (1979)
Professor of English/ESL
B.A., University of California, Los Angeles
M.A., California State University, Los Angeles
- Hasegawa, Evelyn (1993)
Associate Professor of Counseling
B.A., California State University, Los Angeles
M.S., California Lutheran University
- Hastey, Raymond (2001)
Associate Professor of Business
Administration B.A., California State
University, Fullerton M.B.A., Chapman
University M.S., Chapman University
- Henderson, Luther L. III (1983)
Professor of Music & Humanities B.M., Eastman
School of Music M.M., Eastman School of Music
D.M.A., The University of Texas at Austin
- Hendricks, Sharon (2006)
Assistant Professor of Speech
B.A., Seattle Pacific University
M.S., University of Washington
- Hentschel, Donald H. (1996)
Associate Professor of Mathematics
B.A., California State University, Fullerton
M.A., California State University, Fullerton
- Hicks, Donald R. (1992)
Associate Professor of Microbiology
B.S., Auburn University
M.S., Florida Atlantic University
- Holmes, George W. (1992)
Associate Professor of Computer Technology B.S.,
California State University, Los Angeles M.S.,
University of Southern California
- Holzner, Julie E. (1996)
Associate Professor of Economics
B.A., M.A., California State University, Long Beach
- Hong, Mickey J. (1999)
Associate Professor of Korean
B.A., University of California, Santa Cruz
M.A., University of California, Los Angeles
- Hsia, Mary (1987)
Professor of English/ESL
B.S., University of Wisconsin, Madison
M.A., Seton Hall University
- Ilano, Carmen Basa (1988)
Assistant Professor of Learning Skills
B.A., B.S.E. St. Theresa's College, Manila
M.S. Ed. Mt. St. Mary's College, Los Angeles
- Jones, David L. (2006)
Assistant Professor of Cinema-TV
B.A., M.A., Loyola Marymount University
- Kaviani, Kian (1992)
Associate Professor of Mathematics
Ph.D., University of Southern California
- Kelly, Kevin (2006)
Assistant Professor of Music
B.A., West Chester University
Ph.D., University of Pennsylvania
- Kendall, Evan (2006)
Assistant Professor of English
B.A., University of California at Los Angeles
M.F.A., California Institute of the Arts
- Kendis, Ronald (1984) Professor of Mathematics
B.A., University of California, Los Angeles
M.S., San Fernando Valley State College
Ph.D., University of California, Los Angeles
- Khollesi, Khalil (2005)
Assistant Professor of Life Science
- Kim, Irene (2000)
Associate Professor of Music
B.A., M.M., University of California, Los Angeles
- Kinney, Daryl (1996)
Associate Professor of English/ESL B.A.,
Widener University
M.A.T., School for International Training
Ph.D., University of Southern California
- Kuntz, Jonathan A. (1985)
Professor of Radio-TV-Film
B.A., University of California, Berkeley
M.A., Ph.D., University of California, Los Angeles
- Landberg, Bjorn E. (1978)
Associate Professor of Chemistry
B.S., University of California, Los Angeles
M.S., Oregon State University

- Lanzer, Kenneth (2000)
Professor of Administration of Justice/Law
B.A., State University New York M.A., State
University New York J.D., National Law School
- Lapp, Ron (1988)
Associate Professor of English/ESL M.A., ESL,
University of Hawaii
- Lee, Sheng L. (1974)
Professor of Mathematics
B.S., National Taiwan University
M.S., University of Southern California
- Lee, Vincent (1988) Professor of Mathematics
B.A., University of Texas, Austin
M.S., California State University, Los Angeles
M.S., University of Southern California
- Lewis, Richard (2001)
Associate Professor of Law
B.S. L., Western State University
J. D., Western State University
- Liao, Richard (1997)
Associate Professor of Chinese & Humanities
B.A., Chinese Culture University, Taiwan
M.A., Chinese Culture University, Taiwan
M.A., University of California, Los Angeles
- Lopez, Boris (2000)
Associate Professor of Counseling
B.A., M.S., M.A., California State University, Los
Angeles
- Lopez, Calixto (2002)
Assistant Professor of Philosophy
B.A., St. John's Seminary
M.A., DePaul University
- Maeck, Alexandra T. (1991)
Associate Professor of English
B.A., Dartmouth College
M.A., Columbia University
Adult Education Certificate, U.C.L.A.
- Magee, Iris (2000)
Associate Professor of Mathematics
B.A., University of Redlands
M.A., California State University, San Bernardino
- Manchester, P. Betsy (2002)
Associate Professor of Nursing
R.N., Truesdale Hospital School of Nursing, Falls
River
B.S., University of Redlands
M.S., University of Phoenix, Los Angeles
- Mardirosian, Robert (1996)
Associate Professor of Mathematics
B.S., University of Southern California
M.S., Mathematics, Claremont Graduate School
- Mardirussian, Galust (1984) Associate Professor
of English
M.A., University of California, Los Angeles
Ph.D., University of California, Los Angeles
(pending)
- Marcklinger, Maureen MSN RN (2006)
Assistant Professor of Nursing
B.S.N., Cornell University
M.S.N., Stony Brook University, New York
- Marlos, Daniel (2004)
Assistant Professor of Photography
Certificates of Color & Commercial Photography,
Los Angeles City College
B.F.A., Youngstown State University
M.F.A., Art Center College of Design
- Martinez, Horacio (1974)
Professor of English/ESL
M.Ed., Loyola University, Los Angeles
M.A., University of California, Los Angeles
- Martinez, Sandra P. (1996)
Associate Professor of English
B.A., University of California, Los Angeles
M.A., University of Michigan, Ann Arbor
- Matranga, Susan B. (1980)
Professor of Disabled Student Services
B.A., University of California, Berkeley
M.A., California State University, Los Angeles
- Matteson, Jon
Assistant Professor of Speech
- McEveety, Jan S. (1981) Professor of Physical
Education
- McMahon, Arnold (1995) Professor of Philosophy
B.A., Loyola University
M.A., University of Southern California
- McLean Webber, Kalynda (2002)
Assistant Professor of Counseling
B.A., M.A., San Diego State University
- Mendez, Rolf J. (1995)
Professor of Cinema and Television
A.A., Cerritos College
B.A., University of California, Los Angeles
M.A., University of California, Los Angeles
- Meyer, Joseph (2005)
Assistant Professor of Social Science
B.A., M.A., Marquette University
- Mezynski, Andrzej (2001)
Associate Professor of Library Science
B.A., San Diego State University
M.S.L.I.S, University of Illinois at Urbana-Champaign
- Miklos, Michael J. (2005)
Assistant Professor of English
B.A., University of California, Irvine
M.A., Ph.D. (pending) University of Southern
California
- Miller, Kelli (2002)
Assistant Professor of Child Development
B.A., University of California at Riverside
M.A., California State University, Los Angeles
- Miller, Michael R. (1992)
Associate Professor of Physical Education
A.A., Humanities, Glendale College
B.A., English, California State University, Los Angeles
M.Ed., Physical Education, Azusa Pacific University
- Miyaki, Lawrence (1979)
Associate Professor of Geography
A.A., Los Angeles City College
B.A., M.S., California State University, Northridge
B.S.O.D., Southern California College of Optometry
- Moody, James (2002)
Associate Professor of Theatre Arts
B.S., Southern Illinois University
M.F.A., University of California, Los Angeles
- Moon, Mattie, C. (1975)
Associate Professor of History
A.A., Los Angeles Southwest College
B.A., M.A., Loyola Marymount University, Los Angeles
- Morimoto, Charlene N. (1980)
Professor of CAOT
A.A., Los Angeles City College
B.S., M.A., California State University, Los Angeles
- Morin, Jose (1996)
Associate Professor of Spanish
B.A., University of California, Los Angeles
M.A., University of California, Los Angeles
Ph.D., University Of California, Los Angeles
- Morrissey, Kevin (2005)
Assistant Professor of Theater
B.F.A., DePaul University
M.F.A., New York University
- Muller, Danielle N. (2002)
Associate Professor of English
B.A., University of California, Santa Barbara
M.A., Ph.D., University of Southern California
- Nazareno, Remy P. (1998)
Associate Professor of Counseling B.A.,
University of the Philippines
M.A., Ateneo de Manila University
M.S., California State University, Los Angeles
- Niemeyer, Susan (2001)
Associate Professor of English/ESL
B.A., Iowa State University
M.A., University of Illinois at Urbana Champaign
- Nikolaychuk, Anatolly (2000)
Associate Professor of Mathematics
B.S., Kiev University, Kiev
M.S., Ph.D., Odessa University Institute of
Technology, Odessa
- Nishioka, Hayward H. (1975) Professor of
Physical Education A.A., Los Angeles City
College
B.A., M.A., California State University, Los Angeles
- Nishimura, Jeffrey (2005)
Assistant Professor of English/ESL
B.A., University of California, Santa Barbara
M.A., University of California, Davis
- O'Boyle, Christina (2004)
Assistant Professor of Earth Science
B.S., M.S., Kent State University
- Obern, Vaughn (1980)
Professor of Cinema
B.A., Principia College
M.F.A., University of California, Los Angeles
- Okamura, Linda (2001)
Associate Professor of Photography
B.A., University of Southern California
B.F.A, Art Center
- Pahl, Juergen (1971)
Professor of Mathematics
B.S, M.S., University of Hamburg
Ph.D., University of Bern
- Parada, Yelgy (1995)
Assistant Professor of Foreign Language
A.A., Los Angeles City College
B.A., California State University, Los Angeles
B.S., Universidad de Oriente
M.A., California State University, Los Angeles
- Park, Christine (2006)
Assistant Professor of Music
B.M., M.A, California State University, Northridge
Dalcroze Eurhythmics Certificate, The Julliard School
- Parsakar, Sandy (1999)
Associate Professor of Counseling
B.A., M.A., California State University, Northridge
- Partlow, Gayle (2000)
Associate Professor of Art
B.A., University of California, Los Angeles
M.F.A., University of California, Los Angeles

- Pashazadeh Monajem, Mohamad (1989)
Professor of Computer Science
B.S., Tabriz University
M.S., Stanford University
- Patthey-Chavez, G. Genevieve (1989)
Associate Professor of English and ESL
B.A., University of California, Los Angeles
M.A., Ph. D., University of Southern California
Postdoctoral Fellow, National Academy of Education
- Payne, Naemah (2002)
Associate Professor of Mathematics
B.S., M.S., California State Polytechnic University,
Pomona
- Phommasaysy, Sean
Assistant Professor of Life Science
- Piday, Mary L. (1995)
Associate Professor of Theatre Arts
B.A., University of Southern California
M.F.A., University of Southern California
- Pierce, Nancy (2000)
Associate Professor of Physical Education/Health
B.S., M.S., California State University, Northridge
- Plotquin, Hector (2001)
Associate Professor of Mathematics
B.S., M.S., the University of Buenos Aires
- Portillo, Ronald
Associate Professor Counseling
- Prichard, Michael L. (1979)
Associate Professor of Engineering/Industrial
Technology
A.A., Los Angeles City College
B.A., M.A., California State University, Los Angeles
- Pumphrey, Reri N. (2005)
Assistant Professor of Counseling
A.A., Los Angeles City College
B.A., California State University, Los Angeles
M.A., Antioch University, Marina del Rey
- Radtke, John G. (1979)
Professor of Radiologic Technology
B.S., Loma Linda University
M.A., California State University, Los Angeles
R.T. (N.M.) CNMT, LAC-USC Medical Center
- Reed, Billy (1996)
Associate Professor of Counseling
B.A., University of California, Santa Barbara
M.A., Point Loma University
- Reisch, Maria F. (1973)
Professor of Physical Education/Dance
B.A., M.A., University of California, Los Angeles
- Rice-Farrand, Frances (2003)
Assistant Professor of Nursing A.S.,
Los Angeles Valley College
B.S.N., California State University, Los Angeles
M.S.N., University of California, Los Angeles
- Rivera, Mario (1997)
Associate Professor of Spanish & Humanities
B.A., M.A., University of California, Los Angeles
- Robinson, Tammy (1996)
Associate Professor of English
A.A., Cerritos College
B.A., University of California, Los Angeles
M.A., California State University, Dominguez Hills
Ed.D., University of Southern California
- Rodriguez, F.J. (1983)
Associate Professor of Sociology
A.A., East Los Angeles College
B.A., California State University, Los Angeles
M.S.W., University of California, Los Angeles
- Rosario, Gertha D. (1993)
Professor of CAOT
A.A., Los Angeles Metropolitan College
B.S., California State University, Fresno
M.A., California State University, Long Beach
- Rossi, Alfred A. (1978)
Professor of Theater Arts
B.S., Loyola University, Chicago
M.A., University of Kansas
Ph.D., University of Minnesota
- Rountree, Jennifer (1990)
Associate Professor of Theater
B.A., University of California, Santa Cruz
M.F.A., University of California, Los Angeles
- Rousey, Stephen
Associate Professor of Health
- Rozenkopf, Francine (1989)
Associate Professor of French
A.A., Los Angeles City College
B.A., M.A., C. Phil, University of California, Los
Angeles
- Rueda, Mary (1989)
Professor of Counseling
B.A., California State University, Los Angeles
M.A., California State University, San Diego
- Ryan, Joseph
Associate Professor of English/ESL
- Salazar, Juliet
Assistant Professor of Mathematics
- Sambrano, Robert (2005)
Assistant Professor of CAOT B.A., Trinity University
M.B.A., University of Texas
- Samplewala, Robert
Assistant Professor of Computer Science
- Sburlan, Aura (2001)
Associate Professor of Child Development
A.A., Los Angeles City College
B.A., M.A., California State University, Los Angeles
- Schenck, Lawrence (1979)
Associate Professor of Business Administration
B.B.A., Nichols College
M.B.A., Suffolk University
- Schmolze, Patricia S. (1978)
Professor, of Child Development
B.A., Mount Angel College
M.A., California State University, Los Angeles
- Schwab, Norman, W. (1995)
Professor of Art
B.A., M.A., M.F.A., California State University,
Los Angeles
- Sechooler, Rochelle L. (1978)
Professor of Psychology
B.A., M.A., Ph.D., University of California,
Los Angeles
- Segal, Ted (2000)
Professor of Counseling
A.A., Los Angeles City College
B.A., California State University, Northridge
M.A., Chapman University Licensed Marriage,
Family, Child Therapist, State of California
- Sherwood, Kenneth G. (1995)
Associate Professor of Speech Director of Forensics
B.S., California State Polytechnic University,
Pomona
M.A., Miami University, Ohio
- Sirott, Amy (2005)
Associate Professor of CAOT
B.S., California State University, Northridge
M.A., California Lutheran University
- Sisko, Diane (1976)
Associate Professor of Theater Arts
B.A., Purdue University
- Skousen, Mary (2005)
Assistant Professor of Child Development B.A.,
California State University, Los Angeles M.A.,
Pacific Oaks College
- Smith, Andrea L. (1986)
Associate Professor of Special Education
B.A., University of Arizona
M.S., California Lutheran University
- Solis, Bernadette L.
Associate Professor of Counseling
B.A., M.A., California State University, Dominguez
Hills
- Sotiriou, Peter E. (1979)
Professor of English
A.B., M.A., University of California, Los Angeles
Ph.D., University of Southern California
- Sow, Nili (2002)
Assistant Professor of Mathematics
B.A., M.A., University of Dakar, Senegal
- Stempel, Thomas R. (1971)
Professor of Cinema
B.A., Yale University
M.F.A. Ph.D., University of California, Los Angeles
- Suovanen, Charles (2000)
Associate Professor of Music
B.M., M.A., California State University, Northridge
- Sweetman, Amy B. (1996)
Associate Professor of Psychology
B.A., M.A., California State University, Los Angeles
- Sweetman, Timothy N. (1996)
Associate Professor of Administration of Justice
B.S., Cal Poly Pomona University
M.P.A., California State University, Northridge
- Tamayo, Flavia J. (2002)
Associate Professor of English
Dual B.A.'s, University of Southern California
M.A., Stanford University
- Tavakoli, Mozghan (1986)
Associate Professor of Computer Science
B.S., M.A., California State University, Los Angeles
M.S., Azusa Pacific (pending)
- Tchen, Bernadette (1991)
Professor of English
B.A., M.A., Universite de Paris – Sorbonne
M.A., Antioch University, Los Angeles
M.A., M.S., Ph.D., University of Southern California
Certificate in Programming and Data Processing,
University of Southern California
- Tinberg, Christine
Assistant Professor of Physical Education/Health
- Tiwari, Braj (1991)
Professor of Business Administration
B.A., M.A., Kanpur University
M.S., Bowling Green State University

Torres, Julio (1999)
Associate Professor of Philosophy
B.A., M.A., California State University, Los Angeles

Vansor, Robert
Assistant Professor of Learning Skills

Vargas, Wilhelm I., Dr.
Assistant Professor
B.S. California State University – Long Beach
J.D. Southwestern University, School of Law
Member State Bar of California, New York, Colorado, and
Washington, D.C. (323) 953-4000 ext. 2754

Varner, Joni K. (1995)
Professor of Cinema-TV
B.A., University of North Carolina, Greensboro
M.A., State University of New York, Buffalo

Vasquez, Barbara Jean (1996)
Associate Professor of Library Science
B.A., California State University, Fullerton
M.S.L.S., California State University, Fullerton

Velez, Patricio (1977)
Professor of Mathematics
A.B., University of the East, Philippines
M.S., University of Santo Tomas, Philippines
DIP. STAT, University of the Philippines
M.S., University of Southern California

Walzer, Andrew (2005)
Assistant Professor of Humanities
B.A., University of California, Santa Cruz
Ph.D., University of Minnesota

Wanner, Dan (2002)
Associate Professor of Music
B.A., Columbia University
M.A., Columbia University
D.M.A., Columbia University

Ward, Jerold M. (2001)
Associate Professor of Counseling
B.A., California State University, Northridge
M.Ed., Suffolk University, Boston
Ph.D., California Graduate Institute

Washburn, Nancy (2000)
Associate Professor of Child Development
B.A., M.A., California State University, Los Angeles

Werble, Cheryl L. (1975)
Professor, Child Development
B.A., California State University, Northridge
M.S., University of Southern California

Windsor, Kevin R. (2000)
Associate Professor of Mathematics
B.A., California State University, Stanislaus
M.S., California State University, Northridge

Wolf, Roger (1977)
Associate Professor of Mathematics
B.S., United State Military Academy
M.A., University of California, Los Angeles

Yazdanian, Mahmood (2006)
Assistant Professor of Electrical Engineering
M.S., University of Southern California

Young, Janice J. (1976)
Professor, Family & Consumer Studies
B.S., M.S., Brigham Young University
Registered Dietitian, American Dietetic Association

Zielinski, Frances (1989)
Professor of Counseling
A.A., Los Angeles City College
B.S., M.S., California State University, Los Angeles

CHILD DEVELOPMENT CENTER FACULTY

Director:
Melton, Jane (1980)
B.A., Pacific Oaks College
State of California Teaching Credential K-12,
California State University, Los Angeles

Teachers:
Bauman, Mary
B.A., Elementary Teaching Credential, California
State University, Los Angeles

Gavaldon, Rebecca
B.A., California State University, Los Angeles
MFCC, Pacific Oaks College
M.A. (pending thesis)

Ruiz, Evangelina C.
B.A., California State University, Los Angeles
M.S., ECE, California Lutheran University

Schoor, Laura
B.A., New York State University
M.Ed., Xavier University

Sburlan, Aura Felicia
B.A., Elementary Teaching Credential, California
State University, Los Angeles

Gish-Persi, Catherine
B.A., Immaculate Heart College
Calif. Standard Teaching Credential K-9
MA (in process), ECE, California State University,
Northridge

EMERITI FACULTY

Wesley C. Abbott
Music, 1975-2005

John Acken
Cinema-Television, 1975-1997

Dewey D. Ajioka
English, 1954-1979

David Alexman
Architecture, 1964-1993

Blanca L. Alquijay-Swiat
Foreign Languages, 1992-1996

Calvin Anderson
Library, 1962-1992

Elizabeth Reed Annis
Foreign Languages, 1946-1965

Victor E. Arai
Life Science, 1973-2005

Darwin Aronoff
Library, 1970-1994

Barbara C. Azar
CAOT 1992 -2007

James B. Badcon
Economics, 1957-1977

Gwendolyn R. Balitzer
Library, 1953-1970

Gary Baran
Philosophy, 1974-2001

Mary J. Barber
Counseling, 1975-1989

Forrest L. Barker
Electronics, 1962-1989

Shirley H. Barker
Psychology, 1969-1988

Hobart Barnett
English, 1946-1975

Bernice Bedford
Life Sciences, 1989-2005

Benedict Beit-Ishoo
Foreign Languages/Humanities, 1991-2002

Barbara C. Benjamin
Foreign Languages, 1974-1995

James W. Bentley
Radio-TV-Film, 1974-1989

Dorothy Bess
Radiology Technology, 1967-1987

Augusto J. Bissiri
Counseling, 1955-1989

Blackiston, Rosa L.
Mathematics, 1971-2004

Frances R. Blemker
Family & Consumer Studies, 1981-1993

Armida Bolton
Journalism, - 1995

Elia Bonino
Physical Education, - 1982

Franklin L. Booth
Counseling, 1975-2003

Boretz, Marianne S. English/ESL,
1975-2003

Elia Dora Bonino
Physical Education, 1953-1982

Alfred Bornstein
Philosophy, 1969-1991

Ronald L. Botchan
Physical Education, 1966-2001

George Bowden
Television, 1975-1995

Bernard J. Brennan
Chemistry, 1974-1983

Rose B. Brooks
Music, 1969-2001
Louise Brown
Foreign Languages, 1967-1989

George R. Buckner
Dental Technology, 1971-1978

Henderson G. Burns
Psychology, 1949-1979

John Burns
Mathematics, - 2005

Ronald Burton
Media Arts, 1971-1995

Helen B. Bussell
Music, 1971-1995

- Lucy Ann Cade-Wilson
Counseling, 1969-1994
- Virginia L. Campos
English, 1947-1983
- Russell Cangialosi
Art, 1956-1983
- Lang L. Cantrell
Economics, 1948-1973
- Richard A. Carl
Electronics, 1973-1976
- Luis A. Carlos
Foreign Languages, 1974-1994
- Charlene C. Carnachan
Office Administration, 1970-1993
- Henry Catalado
Mathematics, 1968-1995
- Caquese Chaffin
Nursing; Counseling, 1963-1995
- James S. Charness
English 1966-2008
- Robert Cheng
Law, 1974-1999
- Tung Cheng
Foreign Languages, 1959-1995
- Margaret Modlish Chesire
Music 1962-1986
- Barbara Ching
Business Administration 1976 -2008
- Penelope K. Choy
English, 1975-2007
- Armando Cisneros
Mexican-American Studies, 1971-2002
- Howard D. Cohen
Political Science, 1986-2004
- Mildred Collins
Dean of Academic Affairs, 1969-1991
- Renato S. Colantoni
Computer Technology, 1974-2007
- John H. Cook
Business Administration, 1956-1978
- James N. Cox
English, 1963-1983
- Charles Cramer
Business Administration 1969-
- Mary Crockett
American Cultures, 1979-1999
- Elizabeth Jane Crowe
Family & Consumer Studies, 1959-1985
- Laszlo J. Cser
Music, 1978-2005
- Paul D. Cummings
Law, 1979-2004
- Ruth Cushman
Admissions, - 1975
- Milton E. Davis
Life Science; Counseling, 1968-1989
- Raoul A. de La Sota
Art, 1968-1997
- Thomas A. Devine
Sociology, 1971-1973
- Harold C. Dippre
History, 1967-1985
- Domonick A. Di Sarro
Music, 1958-1983
- Joseph R. Docjsak
Media Arts, 1971-2005
- Michael Dombrowski
Physics, 1979-2007
- Jeanne Donahue
- Frank F. Doig
Physical Education, 1938-1973
- Elmer W. Douglas
Physical Education, 1968-1992
- Edward T. Duda
Physical Education, 1953-1967
- Henry L. Ealy, Jr.
American Cultures, 1972-2004
- Randall L. Edwards
Theatre Arts, 1966-1995
- Arther L. Eller
Engineering, 1949-1983
- George L. Elliott
Computer Science & Electronics, 1966-2004
- Dennis B. Ellmore
Art, 1979-2001
- Ruth Evans
Health, 1969-1986
- Guin Porter Ewing
History, 1955-1989
- Donald V. Farrand
Physics, 1956-1989
- Nina George Fedan (Seegman)
Art, 1961-1976
- Lucille Paradela Fernandez
Nursing, 1972-1987
- Bruce Ferrell
Library Services, 1968-1985
- Stelle Feuers
President, 1977-1989
- Ann Fogel
Psychology, - 1995
- Paul H. Fischer
Psychology, 1958-1979
- Ann Jarvis Fogel
Psychology, 1973-1995
- Helen R. Fogelquist
English, 1959-1983
- John Formsma
Mathematics, 1969-2001
- June Forrester
Counseling, 1973-1989
- Ruth Frank
- Sooren Frankian
Social Sciences, 1929-1963
- J. Celeste Frey
Microbiology, 1973-1992
- Paul R. Furguson
English, 1946-1975
- Ruth L. Funk
History, 1956-1973
- Elizabeth W. Gallagher
Anthropology & Counseling, 1965-2004
- Wallace F. Garner
Dental Technology, 1972-1993
- Benjamin K. Gold
Research Director, 1947-1982
- Donald Garrett
Geology, 1969-2001
- Carolyn Z. Glasier
Physical Education, 1967-1995
- John Grasham
- F.O. Greene
Business Administration, 1972-1991
- Kenneth J. Griffin
Physical Education, 1946-1977
- John D. Griffith
Physics, 1966-2002
- Luther C. Guynes
Business Administration, 1971-2005
- Marcus Haile
Chemistry, 1968-1994
- Dolores Hamilton
Foreign Language, 1946-1974
- Lee Hancock
- Milton N. Hand
Physical Education, 1932-1972
- Mary E. Hanley
Assistant Dean of Administrative Services,
1962-1984
- LaDine C. Hanson
Secretarial Sciences, 1949-1976
- J. Robert Harper
Chemistry, 1946-1971
- Dwight T. Harrison
Political Science, 1948-1977
- Tiiu Parli Harunk
Physical Education, 1962-1995
- Helen Hayes
Anthropology, 1965 - 2003

Luther Hayes Counseling, 1972-2002	George J. Kelly English, 1969-2002	James G. Luter Speech, 1964-2002
Jerry Hendrix Cinema/TV, -2004	David S. Kinnory Chemistry, 1964-1989	Manning MacDonald History, 1966-1983
Eugene Hess Life Science, 1950-1987	Jeannette Harris Klose English, 1966-1995	Robert MacDonald Music, 1964-1974
Atilla B. (Gwen) Hill Humanities, 1972-2002 Henry T. Hikida Dental Technology, 1956-1988	Marien K. Knight Secretarial Sciences, 1968-1973	Evelyn S. Malueg Counselor, 1935-1971
Phyllis C. Hirsh Life Science, 1987-1989	Olga S. Kooyman Art, 1968-1983	Estelle M. Marer Mathematics, 1953-1981
Jeanne Hoeck Dean, LACCD, 1961-1983	Josephone Kopenhaver Art, 1948-1973	Marsha B. Mark Life Sciences, 1967-
Thelma E. Holdridge Secretarial Sciences, 1954-1970	Robert L. Kort Psychology, 1965-1995	Harry Matison Mathematics, 1946-1976
G. Truett Hollis Music, 1979-1989	Shirley Krauthamer Psychology, 1973-1995	Andrew L. Maverick Engineering/Computer Technology, 1955-1993
Roberta E. Holt Computer Applications & Office Technology, 1965-02	Marilyn Ladd Physical Education, 1987-1989	Emily Maverick Chemistry, 1964-1989
Ora M. Hook Psychology, 1966-1992	Frank V. laFeriere English, 1961-1995	Virginia Maxm English
Barbara Joe Hoshizaki Biological Sciences, 1959-1988	Lucille G. Lanz Family & Consumer Studies, 1961-1975	Anatol Mazor Life Science
Douglas M. House Business Office, 1956-1987	Melba B. Lawrence Speech Communication, 1969-1989	Thomas J. McCarthy English, 1966-1982
Ann S. Hoxie Office Administration, 1972-1989	Michael L. Lazare Psychology/Counselor 1979 -2007	Ethel McClatchey Psychology & ITV Director, 1989-1995
Joan R. Hudiburg Family & Consumer Studies, 1973-1995	Randal H. Lease Law, 1947-1974	James R. McCloskey Theatre Arts, 1950-1982
Paul Ichnio Radiologic Technology	George M. Lebecki Russian, 1967-1995	Edward J. McDonnell Business Administration, 1970-2001
Jackie Ireland Vice President of Academic Affairs, 1997 - 2007	Melvin Paul Lesser History, 1962-1988	Betty J. McKiver Counseling 1988 -2007
Garrett Jackson English/ESL, 1970-1998	Celeste Lindgren Life Science	Fern L. McNeal Dental Assisting, 1956-1978
David L. Jennings Geography, 1948-1980	Joseph Lingrey Photography, 1980-1994	Margaret S. Meacher Physical Education, 1938-1973
Carol L. Johnson Mathematics, 1981-2002	Rose M. Lint Family & Consumer Studies, 1947-1972	Norman Mennes Theatre Arts, 1955-1985
Eve S. Jones Psychology, 1966-1992	Donald N. Lipman English, 1966-2004	Leo P. Mesner English, 1966-1969
Harold K. Jordan Photography, 1939-1973	Alice F. Logrip Life Sciences, 1976-2003	David G. Miller Physics, 1976-1995
George W. Kaliones Political Science, 1948-1984	Robert Lott Sociology, 1966-1995	Jess Millman Psychology, 1948-1978
Rosella Kanari Mathematics, 1953-1974	David Lowe Architecture, 1976-1999	Armando Missadin Foreign Languages, 1967-1983
Alexander C. Keith Physical Education, 1975-2004	Dick E. Lowry Architecture, 1975-1996	Dennis K. Mitchell Chemistry, 1980-2009
Elizabeth Keller Chemistry, 1994-2001	Lucille Lowry Physical Education, 1949-1965	Franklin Modisett Speech Communication, 1973-1995
	Donald J. Lund Dental Technology, 1965-1982	Margaret Modlish Music, 1962-1986

- William Monroe
Real Estate, 1977-2002
- David Moody
Speech
- Gilbert Moore
- Margaret B. Moore
Family & Consumer Studies, 1968-1989
- Nita Moots-Kincaid
English 1997 - 2009
- Phyllis S. Muldavian
Art 1973 -2008
- Nairn, Janet (1988)
Media Arts, 1988 - 2006
- Beverly N. Nelson
English, 1974-1995
- Dorothy A. Nelson
Physical Education, 1958-1979
- Verner N. Nelson
Accounting, 1948-1982
- Mark Shepard Newton
Earth Sciences, 1965-1993
- Donald Newmeyer
Physical Education, 1930-1967
- Florence C. Niles
History, 1959-1977
- Wallace U. Olson
Art, 1949-1974
- Tsuyoshi Osumi
Mathematics, 1981-2004
- Pat Owen
English/ESL, 1977-2000
- Bennie James Padilla
Counseling, 1970-1995
- John R. Park
Chemistry, 1947-1978
- Ronald K. Pelton
History, 1969-2004
- Audrey Peterson
E.L. Peterson
- Marian E. Petit
Physical Education, 1930-1962
- Alice W. Philleo
Physical Education, 1933-1962
- Harold H. Pokras
Chemistry, 1966-1988
- Robert W. Pollyea
Counseling, 1971-1992
- Phillip M. Pote
Physical Education, 1977-1989
- Margaret Preininger
Transportation, 1929-1956
- Stephen Pritko
Physical Education, 1955-1986
Henrietta B. Quattrocchi
Anthropology, 1969-1985
- Violet C. Randall
Office Administration, 1968-1983
- Maria A. Reichenbach
Philosophy, 1949-1974
- Harriet D. Rice
Business Administration, 1977-1995
- Robert Rivera
Speech Communication, 1979-1981
- Helen Hayes Rivero, -2004
Anthropology
- Charles R. Robinson
Graphic Arts, 1970-1980
- Martha Jo Roff
Theatre Arts, 1967-1984
- Howard A. Rogers
Social Science, 1968-1988
- Charles I. Romero
Speech, 1976-2004
- Sharon S. Rose
CAOT 1989 - 2007
- Elnora A. Ross
Family & Consumer Studies, 1976-1989
- Donald W. Rowe
Music/Counselor, 1935-1975
- Burell B. Rudolph
Law, 1948-1979
- Eudora Russell
Developmental Communications, 1971-1987
- Jacqueline H. Russo
Humanities, 1976-2004
- Marylou W. Saich
Counseling, 1994-2003
- James Sandoval
Biology, 1966-1995
- Koji Sato
Computer/Electronics Technology, 1966-1994
- Analya Sater
Library Science, 1989-2009
- Pauline E. Schatz
- Stanley L. Schall
Administration of Justice/Law, 1972-1989
- John D. Schellkopf
Speech, 1976-2004
- Linda Scher-Padilla
CAOT, 1975-2004
- Phillip J. Schlessinger
Political Science, 1949-1985
- Kenneth L. Schuster
Media Art/Photography, 1973-2001
- Harice L. Seeds
Business Administration, 1968-1984
- John M. Seely
Physical Education, 1968
- John William Shaw
Sociology, 1946-1977
- Ruth R. Sherman
Chemistry, 1972-1995
- Sarah M. Shuldiner
Nursing, 1969-1975
- Gayle E. Sides
Physical Education, 1973-2002
- Gerald A. Silver
Business Administration, 1961-1995
- Jo Ann Simmons
English, 1960-1986
- Donald J. Simpson
Music, 1974-1995
- Martha Sklar
Mathematics/ Dean,
Academic Affairs, 1976-2004
- Rita L. Smith
Physical Education, 1954-1986
- Robert G. Smith
Architecture, 1946-1976
- Jacob Somerman
Hebraica-Judaica, 1968-1983
- Salvatore P. Spano
Music, 1967-1985
- Clarence Spear
Mathematics, 1967-1977
- Jane B. Spillos
Speech Communication, 1946-1984
- J. Robert Stahley
Radio-TV-Film, 1973-1995
- Rochelle E. Stein
Nursing, 1965-1979
- Fleur Walton Steinhardt
Speech Communication, 1961-2009
- Lois R. Stiles
Learning Skills, 1968-1989
- Hal C. Stone
Assistant Dean of Instruction, 1956-1983
- Jack B. Stutesman
Mathematics, 1955-1993
- Zona G. Swan
Library Services, 1966-1985
- Marie H. Tauber
Foreign Languages, 1966-1975
- William F. Thayer
Counseling, 1967-1993
- Frank M. Thometz
Architecture, 1976-1989
- Carson F. Thomson
Engineering, 1954-1979
Miguel Tirado
Foreign Languages, 1946-1987
- Lucy G. Toberman
Journalism, 1966-1975
- Donna L. Tollefson
Theatre Arts, 1968-1995

John Tonkovich
Transportation, 1955-1992

Peter Tripodes
Math, 1976-1999

Ursula Ulrich
Foreign Languages, 1966-1986

Robert Dean Upp
Law, 1949-1979

Caro Van Stryk
Nursing, 1966-1987

Walter C. Varnum
Psychology, 1931-1965

Ed Vasquez
Radiologic Technology 1979 -2007

Bernice G. Vincent
Office Administration, 1954-1989

Adrienne M. Wagner
Photography, 1970-2003

William A. Wagner
Electronics/Cable Television, 1981-1995

Kayoko Wakita
American Cultures/Counseling, 1971-1989

Thelma E. Ward
Physical Education, 1955-1971

Leanna Watts
Child Development/Dean,
Student Services, 1974-2009

John C. Weaver
Law, 1971-2004

Heather Weber
Life Science, -2005

Anita Weintraub
Biology, 1958-1976

Carlotta Welles
Occupational Therapy, 1968-1978

LaMonte E. Westmoreland
Art, 2000 -2008

Lucille D. White
Mathematics, 1958-1979

Vera W. White
Mathematics, 1977-2002

Lee A. Whitten
Art, 1976 - 2007

Robert Pike Whitten
Speech Communication, 1938-1973

Donald D. Wickenkamp
Dental Technology, 1982-2000

Robert Wilkinson
Music, 1961 -

Edwin W. Williams
Speech Communication, 1961-1989

Don Wilson
Political Science, 1969-1999

Maxine Wilson
Business Administration, 1981-1989

Robert Creed Winters
Economics, 1959-1995

William R. Woodworth
Dental Technology, 1967-1988

Harvey S. Wright
Coordinator, Instruction, 1949-1983

Gail B. Wyatt
Physical Education, 1947-1981

Lillian M. Yamaoka
Health, 1973 - 2007

Edwin A. Young
President/Psychology/Counseling, -1991

Mattie Young
Radiology Technology, 1972-1999

Sonia Younglove
Mathematics, 1975-2005

Arlene Zimmerly
CAOT 1983 -2007

Mae Lee Ziskin
Psychology, 1969-1982

Robert H. Zuber
Men's Physical Education, 1966-1995

Academic Probation - After attempting 12 units, a student whose cumulative grade point average (Effective Fall



G L O S S A R Y

1981) falls below 2.00 is placed on academic probation.

Academic Renewal - A student may initiate a petition to have his/her record reviewed for the removal of grade(s) from permanent record for the purpose of computing the grade point average. A student must meet specific conditions and may only have a maximum of 18 units removed.

Add Permit - A form issued by an instructor which permits the student to add the class if the instructor determines that there is room. Enrollment in the class is official only if the add permit is processed by the office of Admissions and Records.

Advisory, Enrollment - An advisory is a condition of enrollment that a student is advised (but not required) to meet before, or in conjunction with, enrollment in a course.

Appeal - A student request for reconsideration of a decision made affecting disciplinary action, grade change, prerequisite challenge, etc.

Application for Admission - A form provided by the Office of Admissions and Records on which the student enters identifying data and requests admittance to a specific semester.

Articulation Agreement - The community colleges work together with the University of California, the California State University and private postsecondary colleges/universities to establish a course agreement to enable transfer students to receive credit for their academic programs.

Assessment - Assessment is the process the college uses to evaluate student skills in areas such as reading, writing and mathematics and English as a Second Language (ESL).

A.S.O.- Organization which all enrolled students are eligible to join is called the Associated Students Organization.

Associate Degree - A degree (Associate in Arts, A.A., or Associate in Science, A.S.) granted by a community college which recognizes a student's satisfactory completion of an organized program of study consisting of a minimum of 60 degree applicable semester units.

Audit - A student's attendance in a class with permission of the instructor and payment of a fee. No college credit nor grade is given.

CalWORKs Program - CalWORKs (California Work Opportunity and Responsibility to Kids), previously GAIN, is an LACC Program offering training and support services to students receiving TANF (Temporary Assistance to Needy Families), previously AFDC.

CAN - The California Articulation Number System, known as CAN, is a means of identifying comparable courses offered at LACC and other colleges in California. CAN is a system that uses the same prefix and number to identify a course on every participating campus. Each campus has its own number; the CAN is added to denote courses that can be used in lieu of each other at participating colleges.

Catalog Rights - Catalog rights refer to the right of every continuing student to choose one, and only one, catalog under whose course requirements the student is to be evaluated for the purpose of determining whether the student meets the requirements for LACC graduation or for certification to transfer to UC or CSU. The continuing student may select the catalog which was in effect when the student initially enrolled at LACC

or any catalog in effect thereafter through and including the semester when the student petitions for graduation or transfer certification.

Certificate Programs - Program designated for students who are looking for instruction with a high degree of specialization. Certificate programs vary in length and may require less than two years of full-time study, and may be pursued on a part-time basis. At the point of completion students may request the issuance of a certificate of completion.

Certification of CSU General Education Requirements - Completion of a body of transfer courses which meet the general education requirements of the California State University system (CSU).

Concurrent Enrollment - A student may enroll in two mutually dependent courses within the same semester and/or may be simultaneously enrolled at both LACC and a high school or another college.

Cooperative Education - An instructional program that is designed to complement the student's academic training with realistic on-the-job experiences.

Co-requisites - A condition of enrollment consisting of what course is required to be taken simultaneously in order to enroll in another course.

Counseling - Guidance provided by professional counselors in academic, vocational, and personal matters.

Course - A subject of study. Identified by Title and Number; for example: Accounting 1.

Credit by Examination - Credit granted for proficiency previously accomplished through testing.

Cross-Referenced - Course content is the same as another course, e.g. HIST 7 and PHIL 23.

CSU - California State University.

Dismissal - A student on academic or progress probation for three semesters may be dismissed from the College. Once dismissed the student may not attend any college within the Los Angeles Community College District for a period of one year and must petition for readmittance at the end of that period of time.

Drop - A student's official withdrawal from a class.

Elective - Courses which a student may choose without restriction of a particular major program-curriculum.

Full-Time Student - A student enrolled and active in 12 or more units, during the Fall or Spring Semester.

General Education Requirements - A group of courses from several subject areas which are required for graduation by state law.

Grade Points - The numerical value of a college letter grade. A=4, B=3, C=2, D=1, F=0, times the number of units of the course: An A in a 5 unit course equals 20 points.

Grade Point Average (GPA) - The GPA is determined by dividing the total grade points earned by the number of attempted units.

Honors Program – The LACC Honors program is designed for students with a 3.0 GPA or higher who plan on transferring to a four-year college or university.

IGETC – Intersegmental General Education Transfer Curriculum. Completion of all the requirements in the Intersegmental General Education Transfer Curriculum (IGETC) will permit a student to transfer from a community college to a campus in either the California State University or the University of California.

INC – Incomplete. The administrative symbol “INC” is recorded on the student’s permanent record in special situations in which the student has not been able to complete a course due to circumstances beyond the student’s control.

IP – In Progress. A symbol which indicates a course which continues over parts or all of two semesters.

Lower Division – College courses at the freshman and sophomore levels.

Major – A concentration of study in a specified discipline.

Matriculation – A combination of assessment of reading, writing, and mathematics skills; orientation to college programs and services; academic advising and counseling; and the programs and services that enable a student to reach his or her educational goals.

NDA – Non degree applicable Credit courses that do not apply toward a degree and are not transferable.

Non-penalty Drop Period – The first four weeks of a regular semester during which a student’s enrollment in a class is not recorded on the student’s permanent record if the student drops by the deadline. This deadline will be different for short-term and summer session courses.

Pass/No Pass – A form of grading whereby a student receives a grade of Pass (P) or No Pass (NP) instead of an A, B, C, D, or F. A “P” is assigned for class work equivalent to a C or above. “NP” denotes work below a grade of C.

Permit to Register – A form listing an appointment day and time at which the student may register.

Prerequisite – A condition of enrollment that a student is required to meet in order to demonstrate current readiness for enrollment in a course or educational program.

Progress Probation – After enrolling in 12 units, a student whose total units for which a W, NCR or INC has been assigned equals 50 percent or more of the units enrolled is placed on progress probation.

RD – Report Delayed. A temporary administrative symbol which is recorded on the student’s permanent record when a course grade has not been received from the instructor. It is changed to a letter grade when the grade report is received.

Returning Student – A previously enrolled student who did not attend the college during the previous two semesters. Attendance during the summer session is not included in this determination.

Satisfactory Completion – Completion of a course with a grade of “C” or better.

Schedule of Classes – A schedule, giving directions for enrollment and detailed information about the times, locations, and instructors of the classes to be offered. It is issued before the beginning of each semester and summer session.

Section Number – A four-digit class identification number which appears in the first column in the class schedule before the time of day or evening the class meets.

Semester – One-half of the academic year usually 15 weeks.

SEP – Student Educational Plan

Subject Deficiency – Lack of credit for a course or courses required for some particular objective such as graduation or acceptance by another institution.

Substandard Grade – An earned grade of D or F.

Transcripts – A student’s permanent record and an official list of all courses taken at a college or university showing the final grade received for each course.

Transfer – A student may change from one collegiate institution to another after having met the requirements for admission to the second institution.

Transfer Courses – Courses designed to match lower division courses of a four-year institution and for which credit may be transferred to that institution.

Transferable Units – College units earned through satisfactory completion of courses acceptable for credit at a four-year college or university.

UC – University of California.

Units – The amount of college credit earned by satisfactory completion of a specific course taken for one semester. Each unit represents one hour per week of lecture or recitation, or a longer time in laboratory or other exercises not requiring outside preparation.

Units Attempted – Total number of units in courses for which a student was ever actively enrolled.

Units Completed – Total number of units in courses for which a student received a grade of A, B, C, D, F, or CR.

Units Enrolled – Total number of units in which the student is enrolled at the end of the non-penalty drop period, which is the total number of units for all courses appearing on the student’s transcripts.

W – An administrative symbol assigned to a student’s permanent record for all classes which a student has dropped or has been excluded from by the instructor after the end of the non-penalty drop date but by the last day to drop.

Withdrawal – The action a student takes in dropping all classes during any one semester and discontinuing coursework at the college.

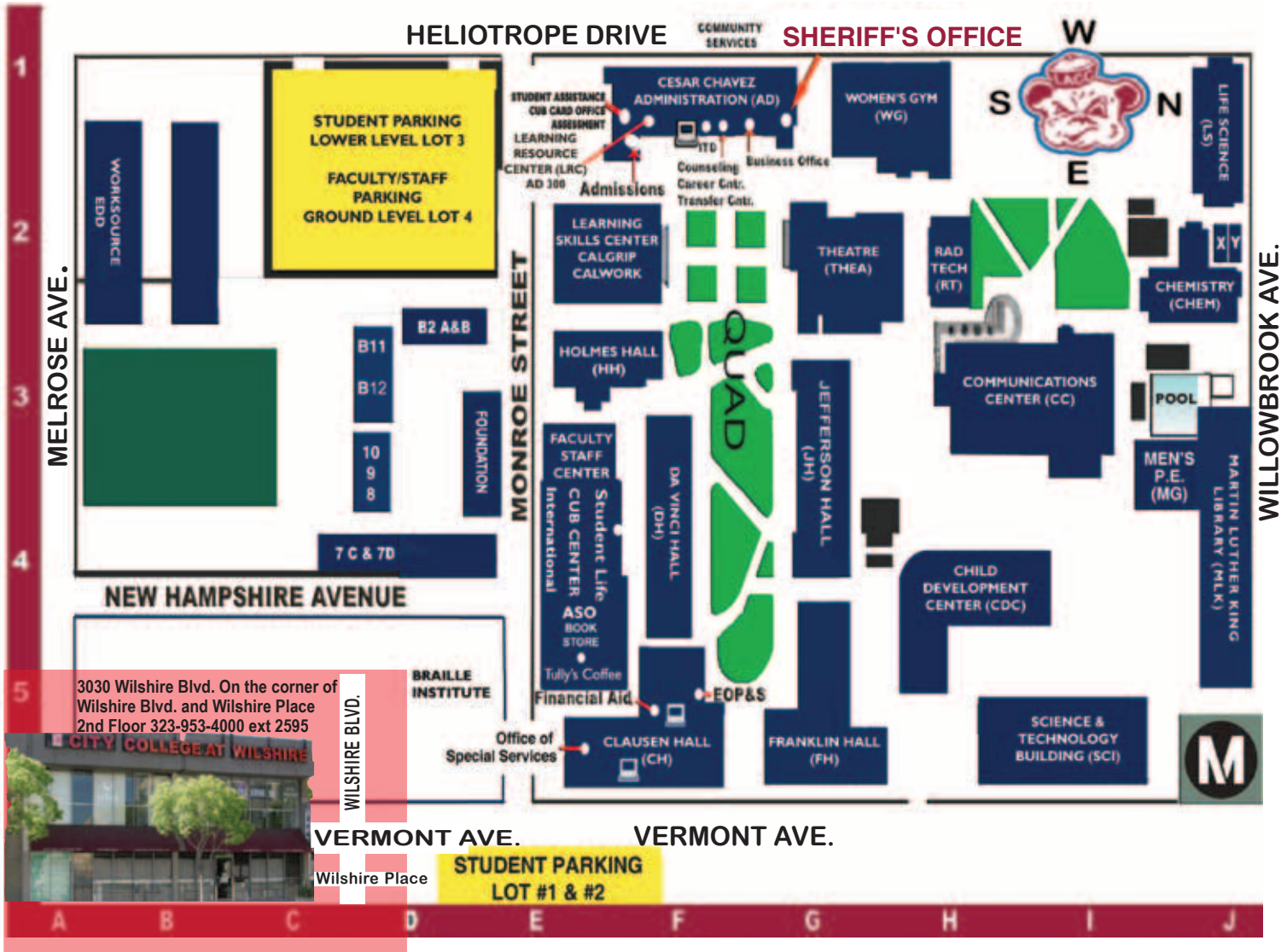
 3030 Wilshire Blvd. On the corner of Wilshire Blvd. and Wilshire Place
 2nd Floor 323-953-4000 ext 2595

WILSHIRE BLVD.

Wilshire Place

To reach a Campus Departments dial **323.953.4000** + the extension listed
Sheriff's Office from any campus phone, dial **#3** or **323.662.5319**

CAMPUS SERVICES

Academic Affair.....	ext. 2052 .. AD 208.....	F1
Admissions	ext. 2104 .. AD 100.....	F1
Assessment	ext. 2246 .. AD 103.....	F1
Assoc. Student Org	ext. 2475 .. CUB.....	F4
Bookstore.....	ext. 2180 .. CUB	E4
Business Office.....	ext. 2180 .. AD 111	G1
CalWorks	ext. 2586 .. LRC 104.....	F2
Career Center	ext. 2210 .. AD 109.....	F1
Child Development	ext. 2220 .. CDC	I4
Community Services.....	ext. 2650 .. *CCW	G1
Counseling.....	ext. 2250 .. AD 108.....	F1
Cub Card Office.....	ext. 2456 .. AD 107.....	F1
Employment Dev. Dept.....	ext. 4002 .. 4311 Melrose.....	E1
English Literacy Program.....	ext. 2230	*CCW
EOP&S	ext. 2300 .. CH 111A.....	F5
Financial Aid	ext. 2010 .. CH 111B.....	F5
Foster Care Cente.....	ext. 2335 .. LRC 205.....	F2
Health Center.....	ext. 2485 .. HH 2.....	E3
Honors Program	ext. 2340 .. AD 205B.....	F1
International Students.....	ext. 2470 .. CUB	E4
Learning Resource Center	ext. 2771 .. LRC	F2
Learning Skills Center	ext. 2770 .. LRC 103.....	F2
Library.....	ext. 2400 .. MLK Library	J4
Lost & Found	#3..... AD 115.....	G1

Matriculation.....	ext. 2246 .. AD 207	F1
Operations Dept.....	ext. 2416 .. Behind Pool.....	F1
Office of Special Services.....	ext. 2270 .. CH 109	E5
Receiving.....	ext. 2495 .. Lot 3	1C
School Rel & Outreach	ext. 2310 .. CH 113.....	F5
Student Assist Center.....	ext. 2455 .. AD 105.....	E1
Student Life.....	ext. 2450 .. CUB.....	F4
Student Services.....	ext. 2460 .. AD 207.....	F1
Transfer Center	ext. 2215 .. AD 109.....	F1
TRIO.....	ext. 2465 .. CH 116.....	F5
Upward Bound	ext. 2316 .. AD 100J.....	F1
Veteran's Affairs	ext. 2024 .. CH 109.....	F5

ACADEMIC DEPARTMENTS

American Cultures	ext. 2505 .. FH217	G3
Art/Architecture.....	ext. 2510 .. DH 220	F4
Athletics	ext. 2852 .. PE 109A.....	I4
Business Administration.....	ext. 2541 .. AD 304	F1
Chemistry/Earth SCI.....	ext. 2600 .. SCI 324.....	BI5
Child Development Center	ext. 2220 .. CDC	I4
Cinema-Television	ext. 2620 .. CC 181	H3
CompAp-Office Tech	ext. 2900 .. DH 212	F4
CSIT/Computer Tech	ext. 2810 .. FH103.....	G3
Dental Tech.....	ext. 2501 .. SCI 324A	I5
Electronics	ext. 2810 .. FH103.....	G3

English/ESL	ext. 2700..... SCI 222	G3
Family & Consumer Studies	ext. 2290 .. AD 200.....	F1
Foreign Language/Humanities	ext. 2737 .. DH 312B	F4
Journalism	ext. 2835 .. Bung. 2A	J2
Law/Admin of Justice.....	ext. 2753 .. HH 211	E3
Learning Skills.....	ext. 2770 .. LRC 103.....	E2
Life Science	ext. 2796 .. SCI 222E.....	I5
Math.....	ext. 2810 .. FH103.....	G3
Music	ext. 2880 .. CH 244	F5
Nursing	ext. 2053 .. SCI 218.....	I5
Philosophy.....	ext. 2761 .. HH 200	E3
Photography	ext. 2835 .. Chem. Build.....	J2
Physical Ed - Men	ext. 2860 .. Men's P.E.....	I4
Physical Ed - Women	ext. 2864 .. Women's Gym	G1
Psychology.....	ext. 2930 .. HH 200	E3
Physics/Engineering	ext. 2924 .. SCI 222D.....	I5
Radiologic Tech (X-Ray).....	ext. 2942 .. RT	H2
Social Science.....	ext. 2561 .. FH 219E.....	G3
Speech	ext. 2967 .. CC 187	H3
Teaching Learning Center	ext. 2480 .. AD 300.....	F1
TheatreArts	ext. 2971 .. THEA	G2
Workforce	ext. 2235	*CCW

* City College at Wilshire (CCW)
 3020 Wilshire Blvd., (East of Vermont ave.)